

SRAM MODULE 2Mbyte (512K x 32-Bit), 3.3V
Part No. HMS51232M4V, HMS51232Z4V

GENERAL DESCRIPTION

The HMS51232M4V/Z4V is a high-speed static random access memory (SRAM) module containing 524,288 words organized in a x32-bit configuration. The module consists of four 512K x 8 SRAMs mounted on a 72-pin, single-sided, FR4-printed circuit board.

PD0 to PD3 identify the module’s density allowing interchangeable use of alternate density, industry- standard modules. Four chip enable inputs, (/CE1, /CE2, /CE3 and /CE4) are used to enable the module’s 4 bytes independently. Output enable(/OE) and write enable(/WE) can set the memory input and output.

Data is written into the SRAM memory when write enable (/WE) and chip enable (/CE) inputs are both LOW.

Reading is accomplished when /WE remains HIGH and /CE and output enable (/OE) are LOW.

For reliability, this SRAM module is designed as multiple power and ground pin. All module components may be powered from a single +3.3V DC power supply and all inputs and outputs are fully LVTTTL-compatible.

FEATURES

- ◆ Access times : 10, 12 and 15ns
- ◆ High-density 2Mbyte design
- ◆ High-reliability, high-speed design
- ◆ Single + 3.3V ±0.3V power supply
- ◆ Easy memory expansion /CE and /OE functions
- ◆ All inputs and outputs are LVTTTL-compatible
- ◆ Industry-standard pinout
- ◆ FR4-PCB design
- ◆ Part Identification
 - HMS51232M4V: SIMM design
 - HMS51232Z4V: ZIP design
- Pin-compatible with the HMS51232M4V

PIN ASSIGNMENT

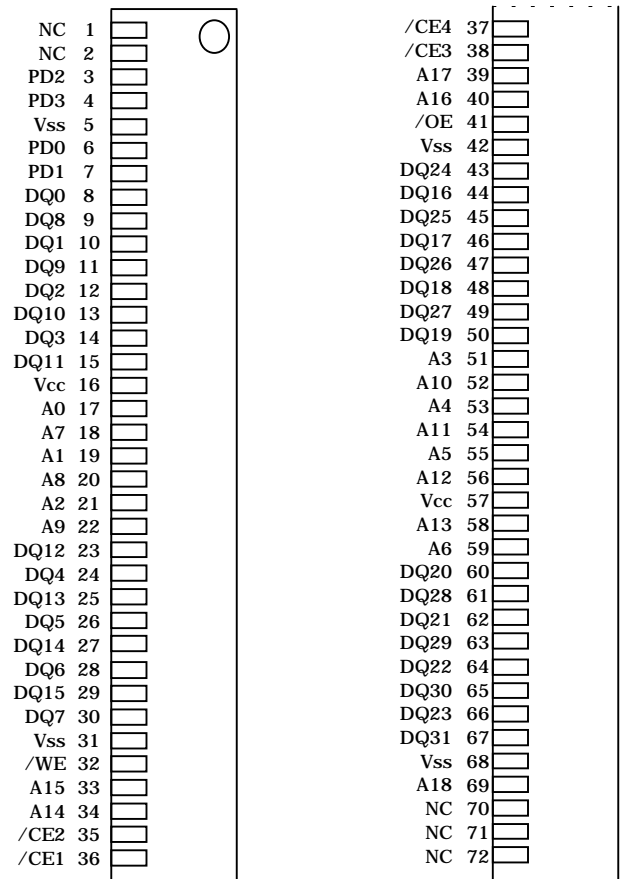

OPTIONS

MARKING

- ◆ Timing
 - 10ns access -10
 - 12ns access -12
 - 15ns access -15
- ◆ Packages
 - 72-pin SIMM M
 - 72-pin ZIP Z

**72-Pin SIMM
TOP VIEW**

PD0 = Open
 PD1 = Open
 PD2 = Open
 PD3 = Vss

FUNCTIONAL BLOCK DIAGRAM

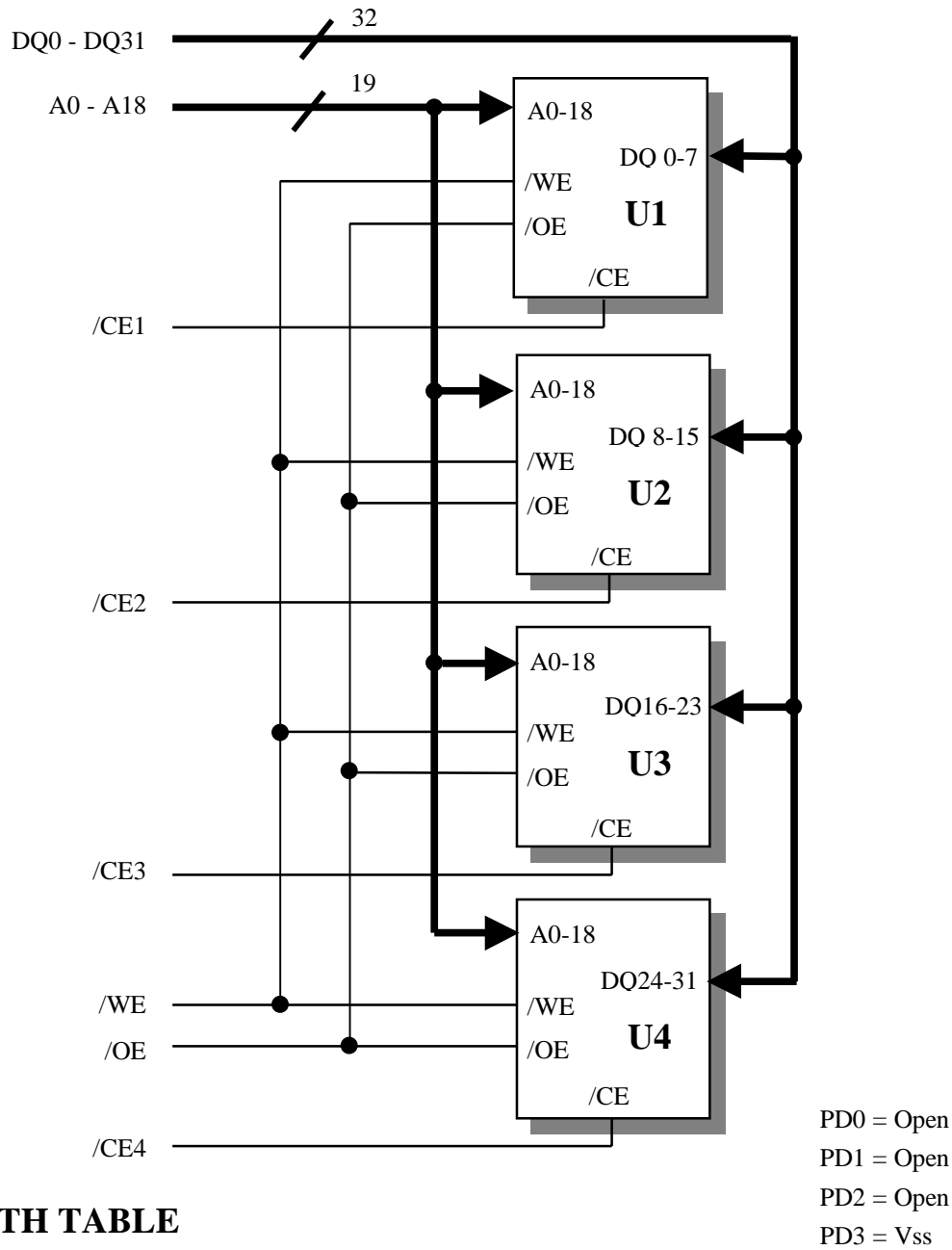

TRUTH TABLE

MODE	/OE	/CE	/WE	DQ	POWER
STANDBY	X	H	X	HIGH-Z	STANDBY
NOT SELECTED	H	L	H	HIGH-Z	ACTIVE
READ	L	L	H	Dout	ACTIVE
WRITE	X	L	L	Din	ACTIVE

ABSOLUTE MAXIMUM RATINGS

PARAMETER	SYMBOL	RATING
Voltage on Any Pin Relative to V _{SS}	V _{IN,OUT}	-0.5V to +4.6V
Voltage on V _{CC} Supply Relative to V _{SS}	V _{CC}	-0.5V to +4.6V
Power Dissipation	P _D	4W
Storage Temperature	T _{STG}	-65°C to +150°C
Operating Temperature	T _A	0°C to +70°C

- Stresses greater than those listed under "Absolute Maximum Ratings" may cause permanent damage to the device. This is a stress rating only and functional operation of the device at these or any other conditions above those indicated in the operating section of this specification is not implied. Exposure to absolute maximum rating conditions for extended periods may affect reliability.

RECOMMENDED DC OPERATING CONDITIONS (T_A=0 to 70 °C)

PARAMETER	SYMBOL	MIN	TYP.	MAX
Supply Voltage	V _{CC}	3.0V	3.3V	3.6V
Ground	V _{SS}	0	0	0
Input High Voltage	V _{IH}	2.0	-	V _{CC} +0.3V**
Input Low Voltage	V _{IL}	-0.5*	-	0.8V

* V_{IL}(Min.) = -2.0V (Pulse Width ≤ 10ns) for I ≤ 20 mA

** V_{IH}(Min.) = V_{CC}+2.0V (Pulse Width ≤ 10ns) for I ≤ 20 mA

DC AND OPERATING CHARACTERISTICS (1)

(0°C ≤ T_A ≤ 70 °C ; V_{CC} = 3.3V ± 0.3V, Unless otherwise specified)

PARAMETER	TEST CONDITIONS	SYMBOL	MIN	MAX	UNITS
Input Leakage Current	V _{IN} = V _{SS} to V _{CC}	I _{LI}	-2	2	μA
Output Leakage Current	/CE=V _{IH} or /OE =V _{IH} or /WE=V _{IL} V _{OUT} =V _{SS} to V _{CC}	I _{LO}	-2	2	μA
Output High Voltage	I _{OH} = -4.0mA	V _{OH}	2.4		V
Output Low Voltage	I _{OL} = 8.0mA	V _{OL}		0.4	V

* V_{CC}=3.3V, Temp=25 °C

DC AND OPERATING CHARACTERISTICS (2)

DESCRIPTION	TEST CONDITIONS	SYMBOL	MAX			UNIT
			-10	-12	-15	
Power Supply Current:Operating	Min. Cycle, 100% Duty /CE=V _{IL} , V _{IN} =V _{IH} or V _{IL} , I _{OUT} =0mA	I _{CC}	205	200	195	mA
Power Supply Current:Standby	Min. Cycle, /CE=V _{IH}	I _{SB}	50	50	50	mA
	f=0MHZ, /CE≥V _{CC} -0.2V, V _{IN} ≥ V _{CC} -0.2V or V _{IN} ≤0.2V	I _{SB1}	10	10	10	mA

CAPACITANCE

DESCRIPTION	TEST CONDITIONS	SYMBOL	MAX	UNIT
Input /Output Capacitance	$V_{IO}=0V$	C_{IO}	8	pF
Input Capacitance	$V_{IN}=0V$	C_{IN}	7	pF

* NOTE : Capacitance is sampled and not 100% tested

AC CHARACTERISTICS ($0^{\circ}C \leq T_A \leq 70^{\circ}C$; $V_{CC} = 3.3V \pm 0.3V$, unless otherwise specified)

TEST CONDITIONS

PARAMETER	VALUE
Input Pulse Level	0 to 3V
Input Rise and Fall Time	3ns
Input and Output Timing Reference Levels	1.5V
Output Load	See below

Output Load (A)

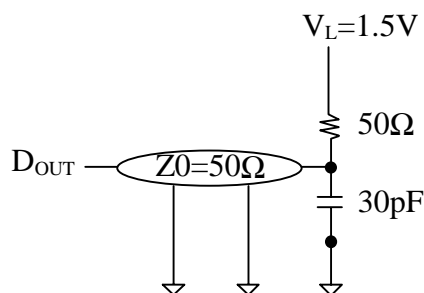

Output Load (B)

for t_{HZ} , t_{LZ} , t_{WHZ} , t_{LOW} , t_{OLZ} & t_{OHZ}

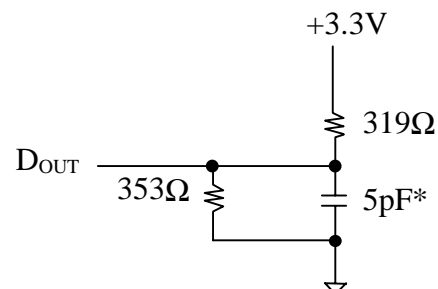

READ CYCLE

PARAMETER	SYMBOL	-10		-12		-15		UNIT
		MIN	MAX	MIN	MAX	MIN	MAX	
Read Cycle Time	t_{RC}	10	-	12	-	15	-	ns
Address Access Time	t_{AA}	-	10	-	12	-	15	ns
Chip Select to Output	t_{CO}	-	10	-	12	-	15	ns
Output Enable to Output	t_{OE}	-	5	-	6	-	7	ns
Chip Enable to Low-Z Output	t_{LZ}	3	-	3	-	3	-	ns
Output Enable to Low-Z Output	t_{OLZ}	0	-	0	-	0	-	ns
Chip Disable to High-Z Output	t_{HZ}	0	5	0	6	0	7	ns
Output Disable to High-Z Output	t_{OHZ}	0	5	0	6	0	7	ns

Output Hold from Address Change	t_{OH}	3	-	3	-	3	-	ns
Chip Select to Power Up Time	t_{PU}	0	-	0	-	0	-	ns
Chip Select to Power Down Time	t_{PD}	-	15	-	12	-	15	ns

WRITE CYCLE

PARAMETER	SYMBOL	-10		-12		-15		UNIT
		MIN	MAX	MIN	MAX	MIN	MAX	
Write Cycle Time	t_{WC}	10	-	12	-	10	-	ns
Chip Select to End of Write	t_{CW}	7	-	8	-	10	-	ns
Address Set-up Time	t_{AS}	0	-	0	-	0	-	ns
Address Valid to End of Write	t_{AW}	7	-	8	-	10	-	ns
Write Pulse Width (/OE High)	t_{WP}	7	-	8	-	10	-	ns
Write Pulse Width (/OE Low)	t_{WP1}	10	-	12	-	15	-	ns
Write Recovery Time	t_{WR}	0	-	0	-	0	-	ns
Write to Output High-Z	t_{WHZ}	0	5	0	6	0	7	ns
Data to Write Time Overlap	t_{DW}	5	-	6	-	7	-	ns
Data Hold from Write Time	t_{DH}	0	-	0	-	0	-	ns
End of Write to Output Low-Z	t_{OW}	3	-	3	-	3	-	ns

TIMING DIAGRAMS

See Part No. HMS51232M4/Z4

FUNCTIONAL DESCRIPTION

/CE	/WE	/OE	MODE	I/O PIN	SUPPLY CURRENT
H	X*	X	Not Select	High-Z	I_{SB}, I_{SB1}
L	H	H	Output Disable	High-Z	I_{CC}
L	H	L	Read	D_{OUT}	I_{CC}
L	L	X	Write	D_{IN}	I_{CC}

Note: X means Don't Care

PACKAGING INFORMATION

SIMM Design

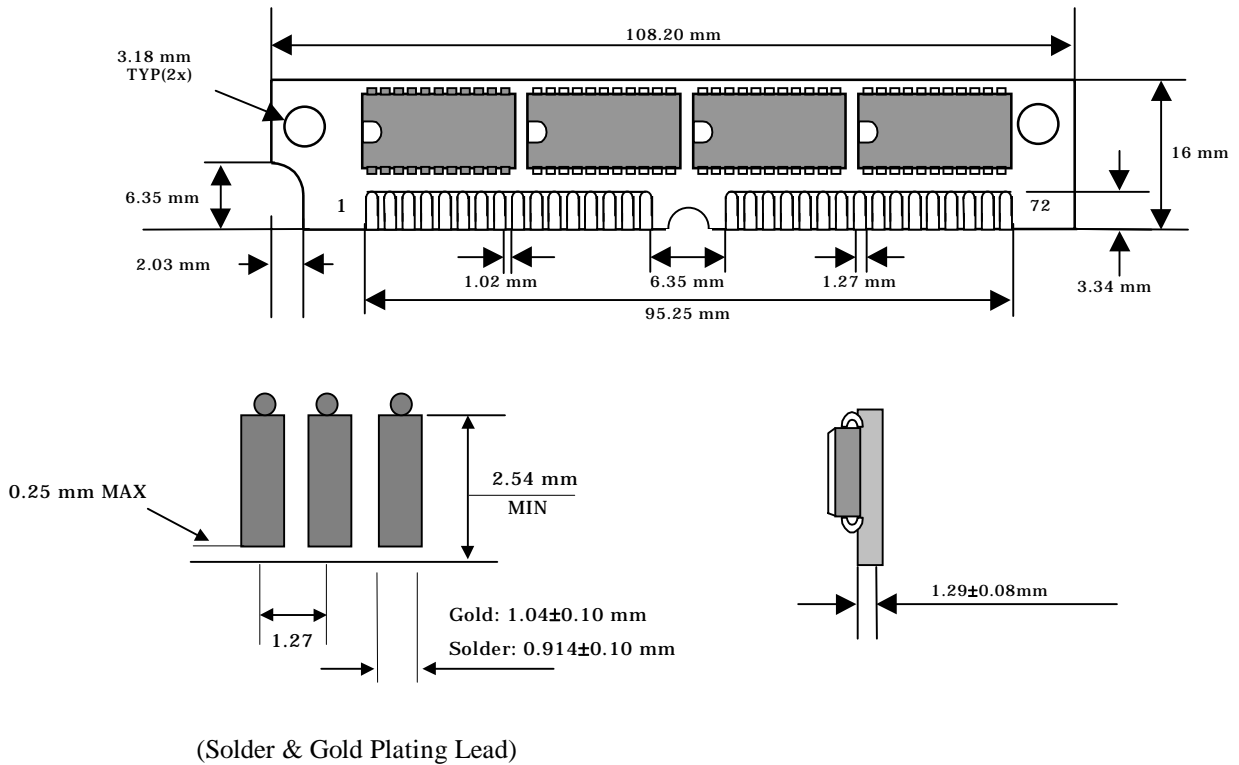

ZIP Design

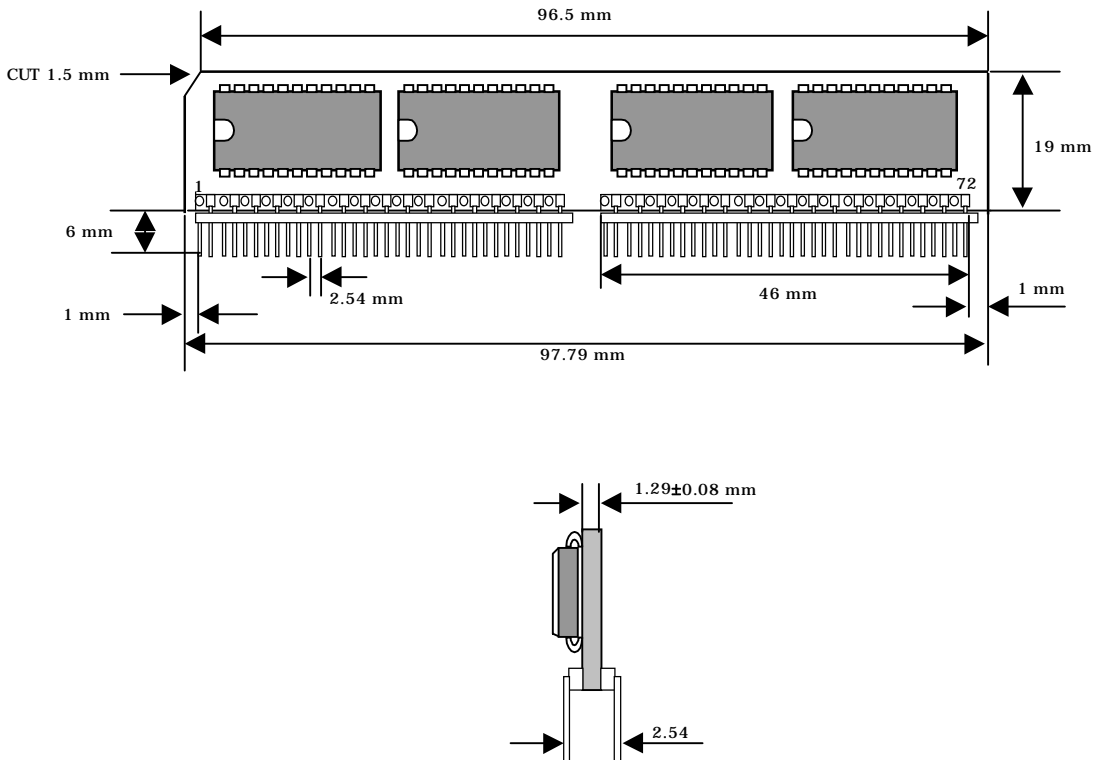

ORDERING INFORMATION

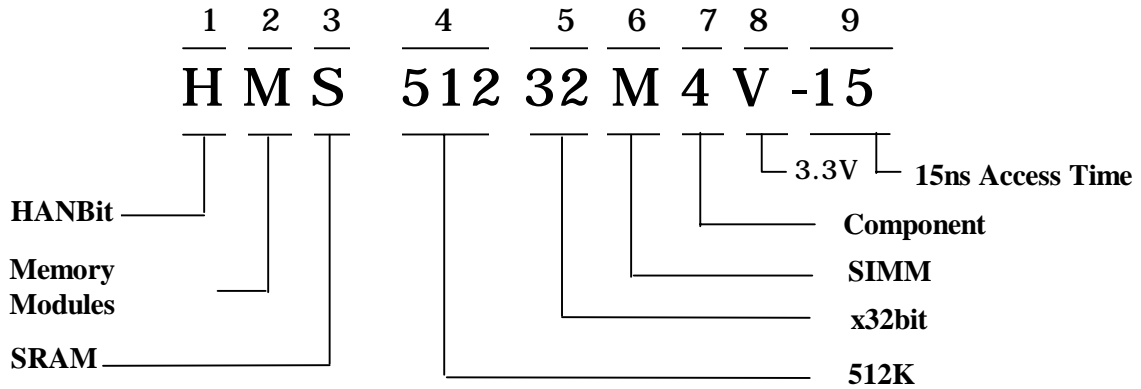

1. - Product Line Identifier

HANBit ----- H

2. - Memory Modules

3. - SRAM

4. - Depth : 512K

5. - Width : x 32bit

6. - Package Code

SIMM ----- M

ZIP ----- Z

7. - Number of Memory Components

8. - V : 3.3V

9. - Access time

10 ----- 10ns

12 ----- 12ns

15 ----- 15ns

17 ----- 17ns

20 ----- 20ns