

Medium Power Film Capacitors



FFVE/FFVI (FFWE/FFWI RoHS Compliant)

DC FILTERING



Not RoHS Compliant



Please select correct termination style.

GENERAL DESCRIPTION

The FFV capacitor is specifically designed for DC filtering, low reactive power.

The series uses a non-impregnated metallized polypropylene or polyester dielectric, which features a controlled self-healing process, specially treated to have a very high dielectric strength in operating conditions up to 105°C.

The FFV special design gives this series a very low level of stray inductance (18 nH to 40 nH).

Furthermore, the performance levels of the FFVE capacitor makes them a very interesting alternative to electrolytic technology, because they can withstand much higher levels of surge voltage, very high rms current ratings, and longer lifetimes.

PACKAGING MATERIAL

Self-extinguishing plastic case (V0 = in accordance with UL 94) filled thermosetting resin.

Self-extinguishing thermosetting resin (V0 = in accordance with UL 94; I3F1 = in accordance with NF F 16-101).

FFVE capacitors meet the Level 2 requirement of the fire behavior standard NF F 16-102.

DIMENSIONS

Also available with threaded female connections - M5 x 7.5mm max Torque 2.5Nm

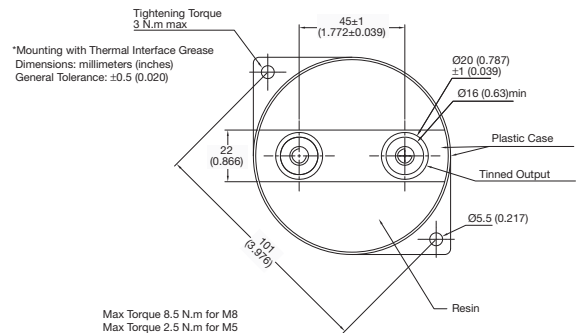
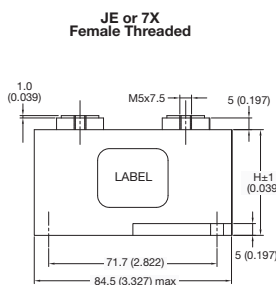
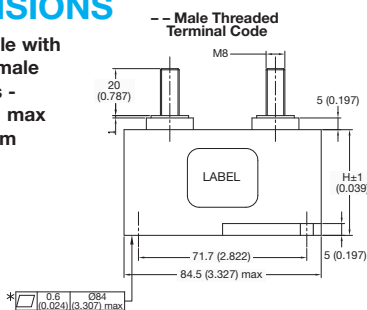

HOW TO ORDER

FFVE

Series

FFVE = Standard
FFVI = Standard
FFWE = RoHS Compliant
FFWI = RoHS Compliant

4

Dielectric

4 = Polyester
6 = Polypropylene

H

Voltage Code

H = 300V L = 1000V
I = 400V (FFVE/FFWE)
J = 500V L = 1100V
K = 600V (FFVI/FFWI)
A = 700V U = 1200V
B = 800V N = 1900V
C = 900V

0187

Capacitance Code

0 + pF code
0187 = 180µF
0356 = 35µF etc.

K

Capacitance Tolerances

K = ±10%

--

Terminal Code

-- or J7 = Male Threaded
JE or 7X = Female Threaded

See Ratings and Part Reference Tables for details

HOT SPOT CALCULATION

See Hot Spot Temperature, page 3.

$\theta_{hot\ spot} = \theta_{case} + (P_d + P_t) \times R_{th}$
with P_d (Dielectric losses) = $Q \times tg\delta_0$
 $Q \times tg\delta_0 \Rightarrow [\frac{1}{2} \times C_n \times (V_{peak\ to\ peak})^2 \times f] \times tg\delta_0$
 $tg\delta_0$ (tan delta)
For polypropylene, $tg\delta_0 = 2 \times 10^{-4}$ for frequencies up to 1MHz and is independent of temperatures. For polyester, $tg\delta_0$ values are shown in graph 4 on page 3.

P_t (Thermal losses) = $R_s \times (I_{rms})^2$

where C_n in Farad I_{rms} in Ampere f in Hertz
 V in Volt R_s in Ohm θ in °C
 R_{th} in °C/W

θ_{case} = bottom center of case

Rs(f) vs FREQUENCY

For frequency higher than 1 kHz use following curve

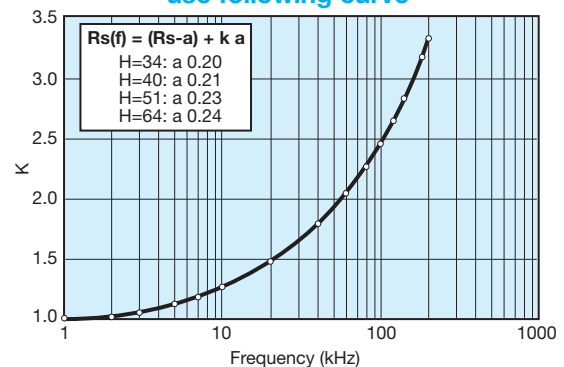

Medium Power Film Capacitors



FFVE/FFVI (FFWE/FFWI RoHS Compliant)

DC FILTERING

ELECTRICAL CHARACTERISTICS – FFVE/FFWE POLYESTER DIELECTRIC

Working temperature	-40°C to +105°C (according to the power to be dissipated)
Capacitance range	100µF to 400µF
Capacitance tolerance	±10%
Rated DC voltage	300 to 400 V
Test voltage between terminals @ 25°C	1.5 x V _n dc 10s
Insulation voltage between shorted terminals and earth	7 kVrms/60sec/50Hz
Dielectric	Polyester

RATINGS AND PART NUMBER REFERENCE – POLYESTER DIELECTRIC

Part Number*	Capacitance (µF)	Height	Irms max. (A)	Ls max. (nH)	Rs (mΩ)	Rth (°C/W)	Typical Weight (g)
V_ndc 300 volts (Voltage Code H)							
FFVE4H0187K--	180	34 (1.339)	100	18	0.8	4.7	300
FFVE4H1956K--	195	34 (1.339)	100	18	0.8	4.4	300
FFVE4H0257K--	250	40 (1.575)	100	25	0.6	5.2	350
FFVE4H0357K--	350	51 (2.008)	100	32	0.8	7.2	420
FFVE4H0407K--	400	51 (2.008)	110	32	0.8	7.1	420
V_ndc 400 volts (Voltage Code I)							
FFVE4I0107K--	100	34 (1.339)	80	18	0.7	4.7	300
FFVE4I0127K--	120	34 (1.339)	100	18	0.6	4.1	300
FFVE4I0157K--	150	40 (1.575)	100	25	0.7	5.0	350
FFVE4I0187K--	180	51 (2.008)	80	32	1.0	8.5	420
FFVE4I0227K--	220	51 (2.008)	100	32	0.9	7.2	420

*Change "--" to "JE" for female connectors M5 x 7.5mm

Dimensions millimeters (inches)

LIFETIME EXPECTANCY FFVE POLYESTER

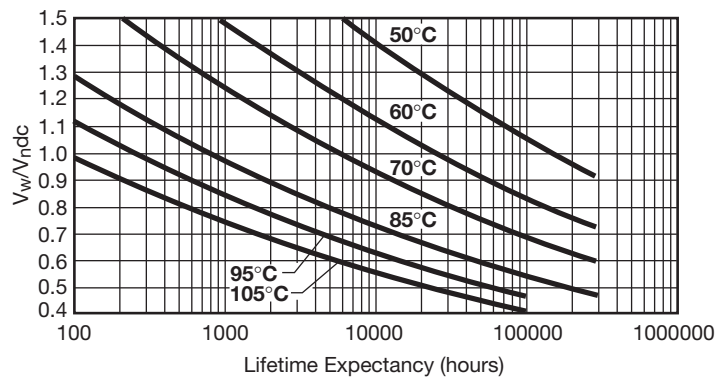

V_w: permanent working or operating DC voltage.



Medium Power Film Capacitors



FFVE/FFVI (FFWE/FFWI RoHS Compliant)

DC FILTERING

ELECTRICAL CHARACTERISTICS – FFVE/FFWE POLYPROPYLENE DIELECTRIC

Working temperature	-40°C to +105°C (according to the power to be dissipated)
Capacitance range	12µF to 220µF
Capacitance tolerance	±10%
Rated DC voltage	600 to 1900 V
Test voltage between terminals @ 25°C	1.5 x V _n dc 10s
Insulation voltage between shorted terminals and earth	7 kVrms/60sec/50Hz
Dielectric	Polypropylene

RATINGS AND PART NUMBER REFERENCE – POLYPROPYLENE DIELECTRIC

Part Number*	Capacitance (µF)	Height	I _{rms} max. (A)	L _s max. (nH)	R _s (mΩ)	R _{th} (°C/W)	Typical Weight (g)
V_ndc 600 volts (Voltage Code K)							
FFVE6K0256K--	25	34 (1.339)	90	18	0.7	4.3	300
FFVE6K0107K--	100	40 (1.575)	100	25	0.6	4.8	350
FFVE6K0157K--	150	51 (2.008)	110	32	0.9	6.9	420
FFVE6K0227K--	220	64 (2.520)	100	40	1.0	8.4	500
V_ndc 800 volts (Voltage Code B)							
FFVE6B0666K--	66	40 (1.575)	100	25	0.7	4.7	350
FFVE6B0107K--	100	51 (2.008)	90	32	1.0	6.7	420
FFVE6B0147K--	140	64 (2.520)	100	40	1.3	8.4	500
V_ndc 900 volts (Voltage Code C)							
FFVE6C0126K--	12	34 (1.339)	70	18	0.9	4.4	300
FFVE6C0386K--	38	34 (1.339)	100	18	1.6	3.9	300
FFVE6C0476K--	47	40 (1.575)	100	25	0.8	4.6	350
FFVE6C0706K--	70	51 (2.008)	100	32	1.2	6.7	420
FFVE6C0107K--	100	64 (2.520)	90	40	1.1	8.2	500
V_ndc 1000 volts (Voltage Code L)							
FFVE6L0666KJ7	66	40 (1.575)	70	25	1.5	5.1	350
FFVE6L0107KJ7	100	51 (2.008)	64	32	2.0	7.3	420
FFVE6L0147KJ7	140	64 (2.520)	51	40	2.5	9.2	500
V_ndc 1200 volts (Voltage Code U)							
FFVE6U0476KJ7	47	40 (1.575)	66	25	1.7	4.9	350
FFVE6U0706KJ7	70	51 (2.008)	59	32	2.4	7.2	420
FFVE6U0107KJ7	100	64 (2.520)	49	40	2.9	8.9	500
V_ndc 1900 volts (Voltage Code N)							
FFVE6N0156KJ7	15	40 (1.575)	73	25	1.1	5.2	350
FFVE6N0246KJ7	24	51 (2.008)	73	32	1.3	6.5	420
FFVE6N0356KJ7	35	64 (2.520)	67	40	1.6	8.4	500

*Change "--" to "JE" for female connectors M5 x 7.5mm
 *Change "J7" to "7X" for female connectors M5 x 7.5mm

Dimensions millimeters (inches)

LIFETIME EXPECTANCY FOR FFVE POLYPROPYLENE

-- and JE

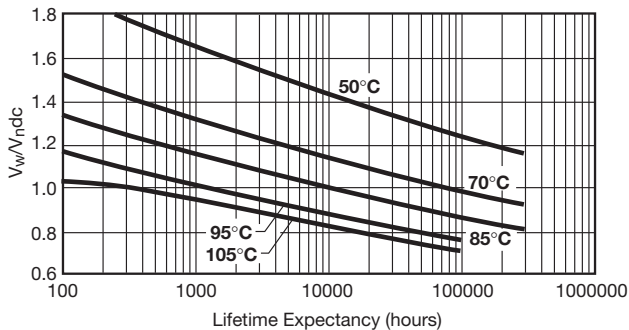

V_w: permanent working or operating DC-voltage.

J7 and 7X

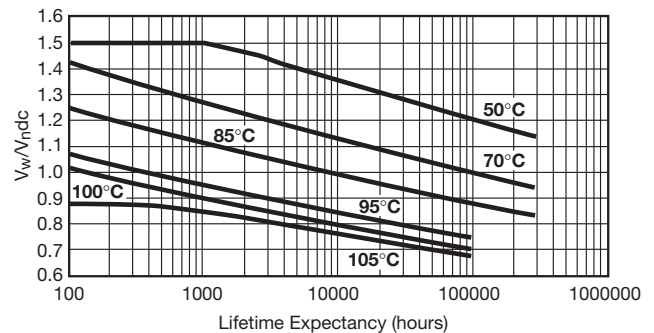

V_w: permanent working or operating DC-voltage.



Medium Power Film Capacitors



FFVE/FFVI (FFWE/FFWI RoHS Compliant)

DC FILTERING

ELECTRICAL CHARACTERISTICS – FFVI/FFWI POLYPROPYLENE DIELECTRIC

Working temperature	-40°C to +105°C (according to the power to be dissipated)
Capacitance range	47µF to 275µF
Capacitance tolerance	±10%
Rated DC voltage	500 to 1100V
Test voltage between terminals @ 25°C	1.25 x V_{Ndc} 10s
Insulation voltage between shorted terminals and earth	7 kVrms/60sec/50Hz
Dielectric	Polypropylene

RATINGS AND PART NUMBER REFERENCE – POLYPROPYLENE DIELECTRIC

Part Number*	Capacitance (µF)	Height	Irms max. (A)	Ls max. (nH)	Rs (mΩ)	Rth (°C/W)	Typical Weight (g)
V_{Ndc} 500 volts (Voltage Code J)							
FFVI6J1256K--	125	40 (1.575)	90	25	0.6	5.0	350
FFVI6J0207K--	200	51 (2.008)	90	32	0.8	6.7	420
FFVI6J2756K--	275	64 (2.520)	90	40	0.9	8.7	500
V_{Ndc} 700 volts (Voltage Code A)							
FFVI6A0107K--	100	40 (1.575)	100	25	0.6	4.8	350
FFVI6A0157K--	150	51 (2.008)	100	32	0.9	6.9	420
FFVI6A0227K--	220	64 (2.520)	100	40	1.0	8.4	500
V_{Ndc} 900 volts (Voltage Code C)							
FFVI6C0666K--	66	40 (1.575)	100	25	0.7	4.7	350
FFVI6C0107K--	100	51 (2.008)	90	32	1.0	6.7	420
FFVI6C0147K--	140	64 (2.520)	100	40	1.3	8.4	500
V_{Ndc} 1100 volts (Voltage Code L)							
FFVI6L0476K--	47	40 (1.575)	100	25	0.8	4.6	350
FFVI6L0706K--	70	51 (2.008)	100	32	1.2	6.7	420
FFVI6L0107K--	100	64 (2.520)	90	40	1.1	8.2	500

Dimensions millimeters (inches)

LIFETIME EXPECTANCY FOR FFVI

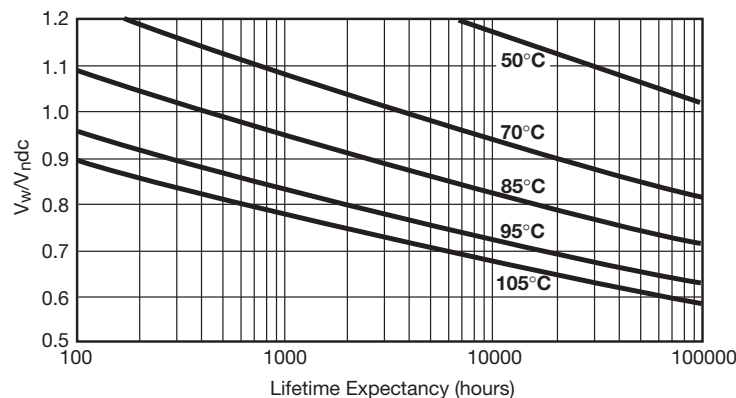

V_w : permanent working or operating DC-voltage.

