

SMD Power Inductor CDRH6D26/HP

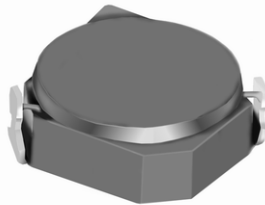

Halogen Free



Description

- Ferrite drum core construction.
- Magnetically shielded.
- L × W × H: 7.0 × 7.0 × 2.8 mm Max.
- Product weight: 0.4g(Ref.)
- Moisture Sensitivity Level: 1
- RoHS compliance.
- Halogen Free available.

Environmental Data

- Operating temperature range: -40°C~+105°C (including coil's self temperature rise)
- Storage temperature range: -40°C~+105°C
- Solder reflow temperature: 260 °C peak.

Packaging

- Carrier tape and reel packaging
- 13" diameter reel
- 1500pcs per reel

Applications

- Ideally used in Mobile phone, MP3, PDA, HDD, DSC/DVC, etc as DC-DC converter inductors.

Dimension - [mm]

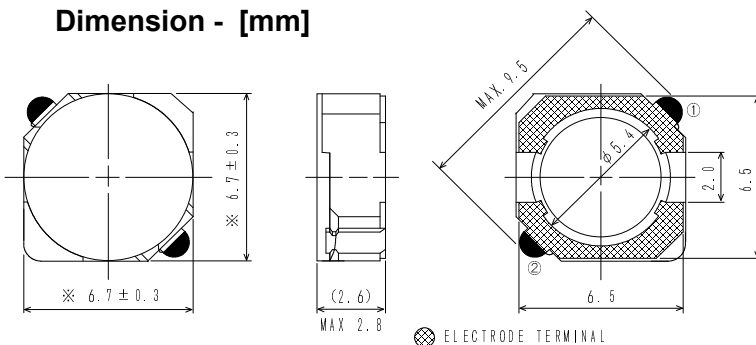

Land pattern and Schematics - [mm]

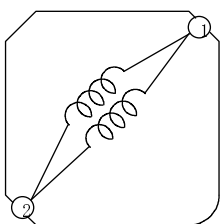
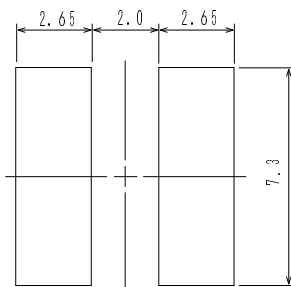

(1.5 μH ~ 10 μH)

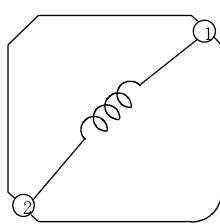

(15 μH ~ 100 μH)

SMD Power Inductor CDRH6D26/HP



Electrical Characteristics

Part Name	Stamp	Inductance (μ H) [within] ※1	D.C.R. (m Ω) Max. (Typ.) (at 20°C)	Saturation Current (A) ※2		Temperature Rise Current (A) ※3
				at 20°C	at 105°C	
CDRH6D26HPNP-1R5PC	1R5	1.5 \pm 25%	20.3(16.2)	6.30	5.20	4.60
CDRH6D26HPNP-2R2PC	2R2	2.2 \pm 25%	23.1(18.5)	5.10	4.20	4.00
CDRH6D26HPNP-3R3PC	3R3	3.3 \pm 25%	26.9(21.5)	4.20	3.60	3.90
CDRH6D26HPNP-4R7PC	4R7	4.7 \pm 25%	41.3(33.0)	3.40	2.90	2.90
CDRH6D26HPNP-5R6PC	5R6	5.6 \pm 25%	48.4(38.7)	3.10	2.80	2.70
CDRH6D26HPNP-6R8PC	6R8	6.8 \pm 25%	64.4(51.5)	2.90	2.55	2.30
CDRH6D26HPNP-8R2PC	8R2	8.2 \pm 25%	83.1(66.5)	2.75	2.35	2.00
CDRH6D26HPNP-100MC	100	10.0 \pm 20%	90.0(72.0)	2.50	2.05	1.80
CDRH6D26HPNP-150MC	150	15.0 \pm 20%	128(102)	2.00	1.70	1.45
CDRH6D26HPNP-180MC	180	18.0 \pm 20%	144(115)	1.85	1.55	1.35
CDRH6D26HPNP-220MC	220	22.0 \pm 20%	174(139)	1.70	1.40	1.20
CDRH6D26HPNP-270MC	270	27.0 \pm 20%	235(188)	1.50	1.25	1.05
CDRH6D26HPNP-330MC	330	33.0 \pm 20%	258(206)	1.35	1.15	1.00
CDRH6D26HPNP-390MC	390	39.0 \pm 20%	283(226)	1.25	1.05	0.95
CDRH6D26HPNP-470MC	470	47.0 \pm 20%	381(305)	1.15	0.95	0.80
CDRH6D26HPNP-560MC	560	56.0 \pm 20%	425(340)	1.05	0.88	0.75
CDRH6D26HPNP-680MC	680	68.0 \pm 20%	470(376)	0.95	0.80	0.70
CDRH6D26HPNP-820MC	820	82.0 \pm 20%	696(557)	0.85	0.72	0.58
CDRH6D26HPNP-101MC	101	100 \pm 20%	758(606)	0.80	0.65	0.55

※1. Inductance Measuring condition: at 100kHz.

※2. Saturation current: The value of D.C. current when the inductance decreases to 65% of it's nominal value.

※3. Temperature rise current: The value of D.C. current when the temperature rise is $\Delta t=40^{\circ}\text{C}$ ($T_a=20^{\circ}\text{C}$).

SMD Power Inductor CDRH6D26/HP



Saturation Current & Temperature Rise Graph

— L (20°C) — L (100°C) — ΔT

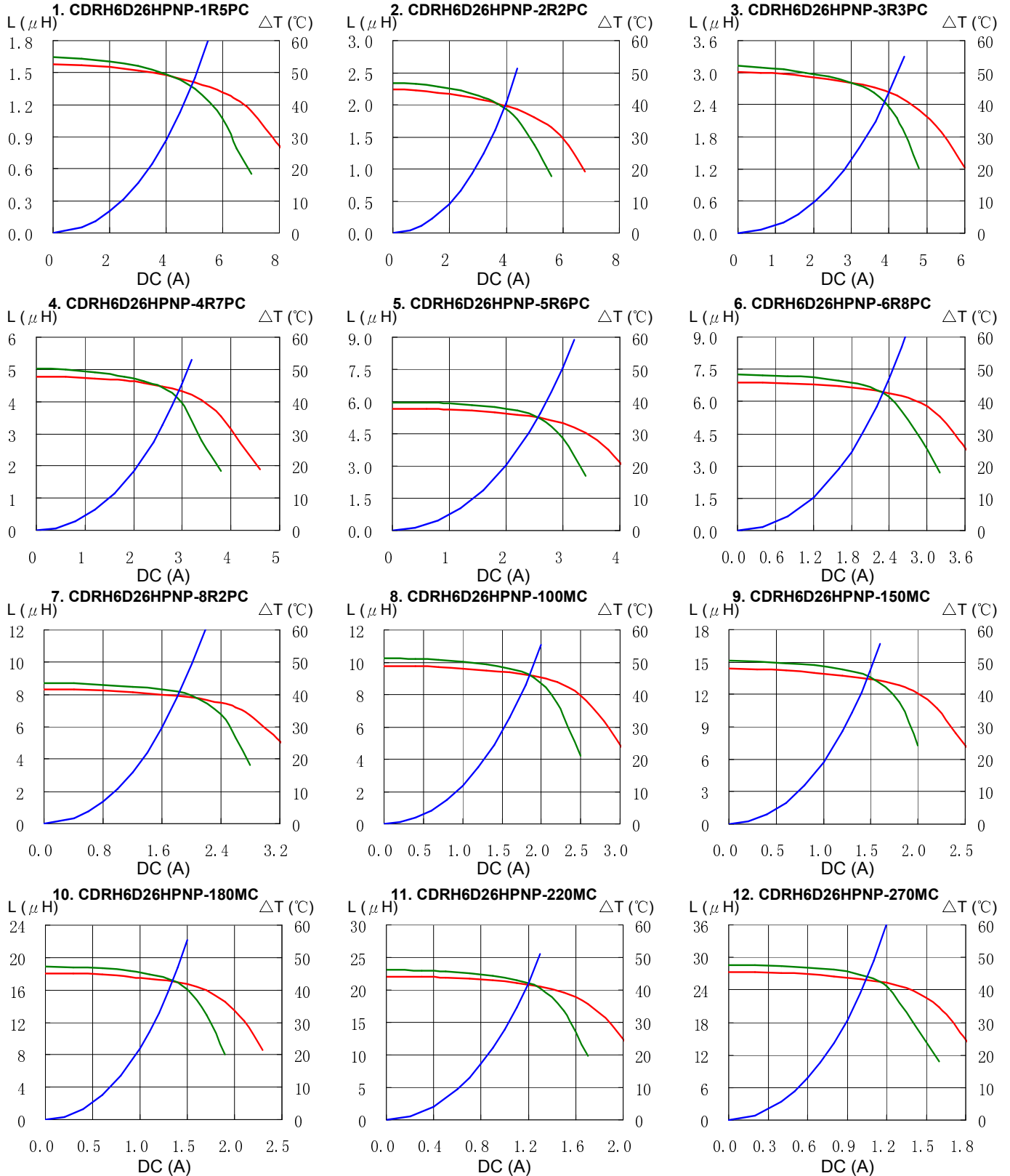

SMD Power Inductor CDRH6D26/HP



Saturation Current & Temperature Rise Graph

— L (20°C) — L (100°C) — ΔT

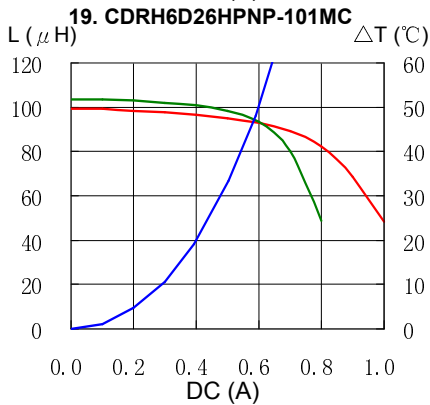
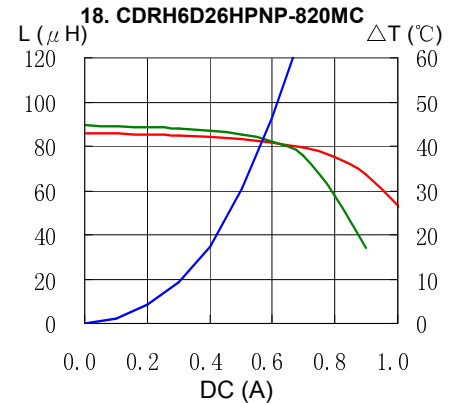
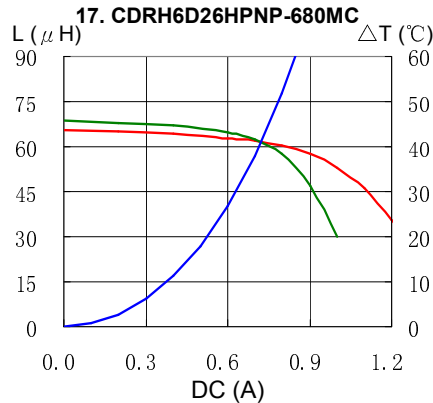
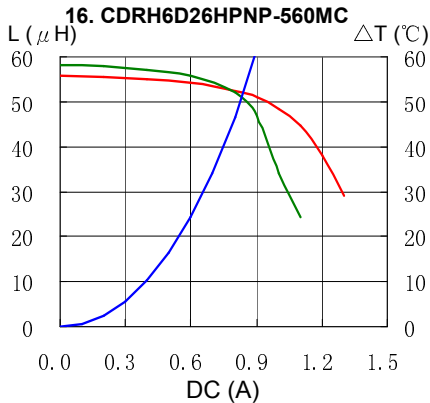
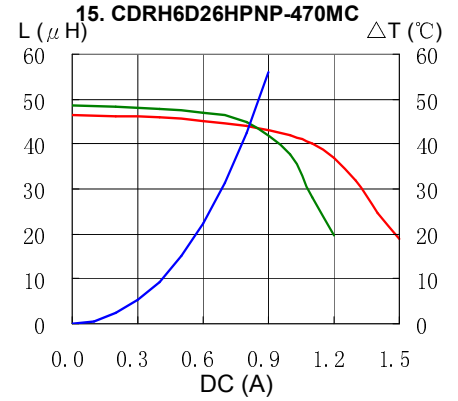
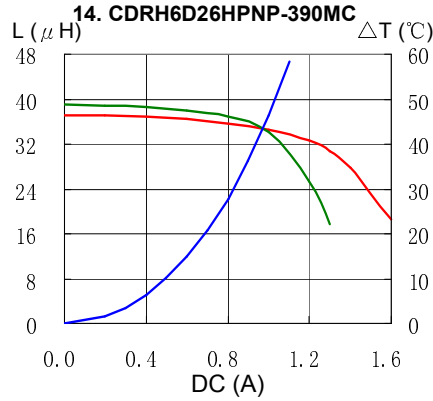
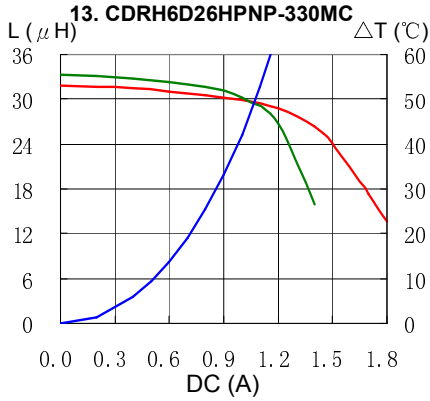

SMD Power Inductor CDRH6D26/HP



Solder Reflow Condition

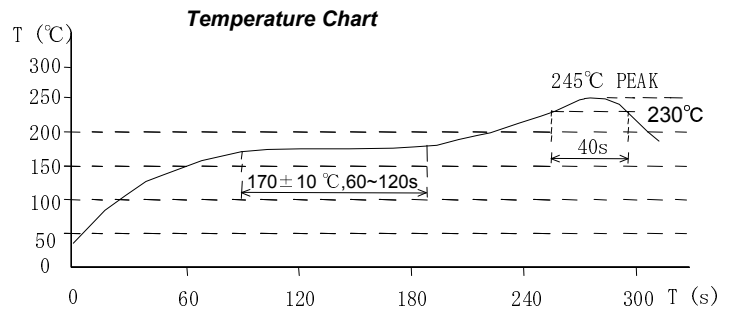
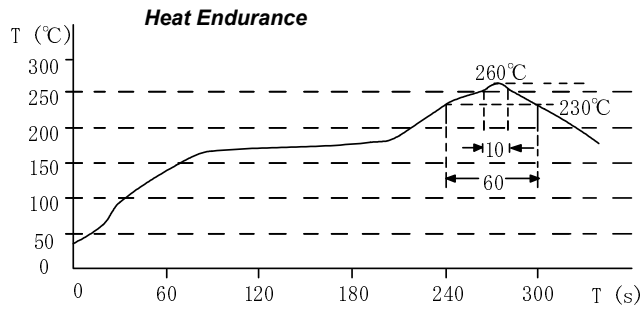

Please refer to the sales offices on our website - <http://www.sumida.com>

Hong Kong

Tel.+852-2880-6781
FAX.+852-2565-9600
sales@hk.sumida.com

Saitama(Japan)

Tel.+81-48-691-7300
FAX.+81-48-691-7340
sales@jp.sumida.com

Chicago

Tel.+1-847-545-6700
FAX. +1-847-545-6720
sales@us.sumida.com

Shanghai

Tel.+86-21-5836-3299
FAX.+86-21-5836-3266
shanghai.sales@cn.sumida.com

Seoul

Tel.+82-2-6237-0777
FAX.+82-2-6237-0778
sales@kr.sumida.com

Oberzell

Tel.+49-8591-937-0
FAX. +49-8591-937-103
contact@eu.sumida.com

Shenzhen

Tel.+86-755-8291-0228
FAX.+86-755-8291-0338
shenzhen.sales@cn.sumida.com

Singapore

Tel.+65-6296-3388
FAX.+65-6841-4426
sales@sg.sumida.com

Neumarkt

Tel.+49-9181-4509-110
FAX. +49-9181-4509-310
infocomp@eu.sumida.com

Taipei

Tel.+886-2-8751-2737
FAX.+886-2-8751-2738
sales@tw.sumida.com

San Jose

Tel.+1-408-321-9660
FAX.+1-408-321-9308
sales@us.sumida.com