

## FEATURES

- InGaP HBT Technology
- -47 dBc ACPR @ + 10 MHz, +24.5 dBm
- 30 dB Gain
- High Efficiency
- Low Transistor Junction Temperature
- Internally matched for a 50  $\Omega$  System
- Low Profile Miniature Surface Mount Package;  
Halogen Free and RoHS Compliant
- Multi-Carrier Capability

## APPLICATIONS

- LTE, WCDMA and HSDPA Air Interfaces
- Picocell, Femtocell, Home Nodes
- Customer Premises Equipment (CPE)
- Data Cards and Terminals

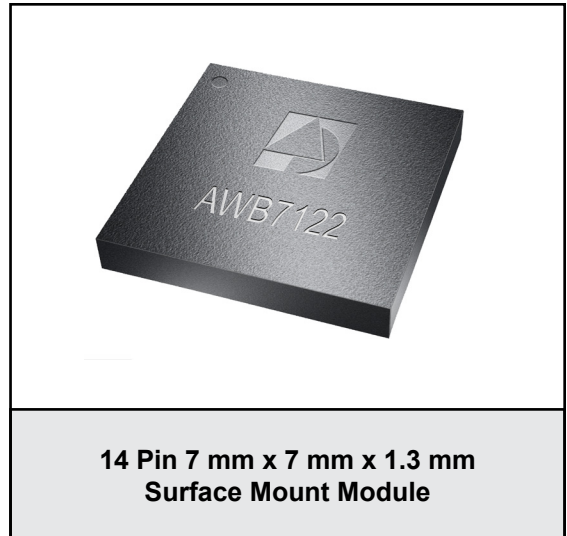

## PRODUCT DESCRIPTION

The AWB7122 is a highly linear, fully matched, power amplifier module designed for picocell, femtocell, and customer premises equipment (CPE) applications. Its high power efficiency and low adjacent channel power levels meet the extremely demanding needs of small cell infrastructure architectures. Designed for LTE, WCDMA, HSDPA air interfaces operating in the 1805 MHz to 1880 MHz band, the AWB7122 delivers up to +24.5 dBm of LTE (E-TM1.1) power with

an ACPR of -47 dBc. It operates from a convenient +4.2 V supply and provides 30 dB of gain. The device is manufactured using an advanced InGaP HBT MMIC technology offering state-of-the-art reliability, temperature stability, and ruggedness. The self-contained 7 mm x 7 mm x 1.3 mm surface mount package incorporates RF matching networks optimized for output power, efficiency, and linearity in a 50  $\Omega$  system.

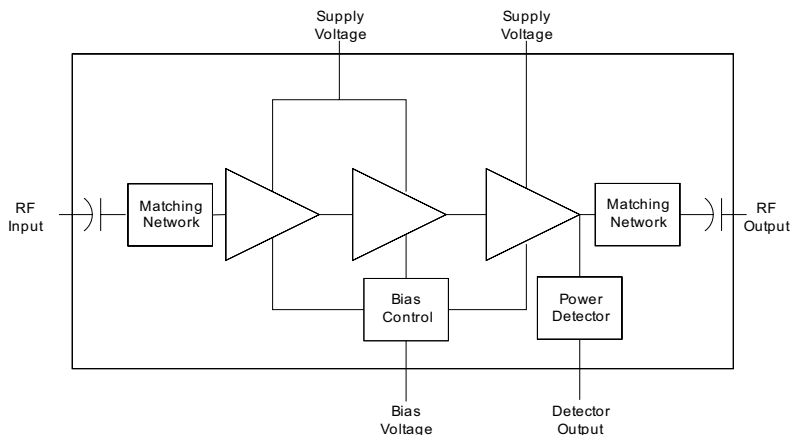

**Figure 1: Block Diagram**

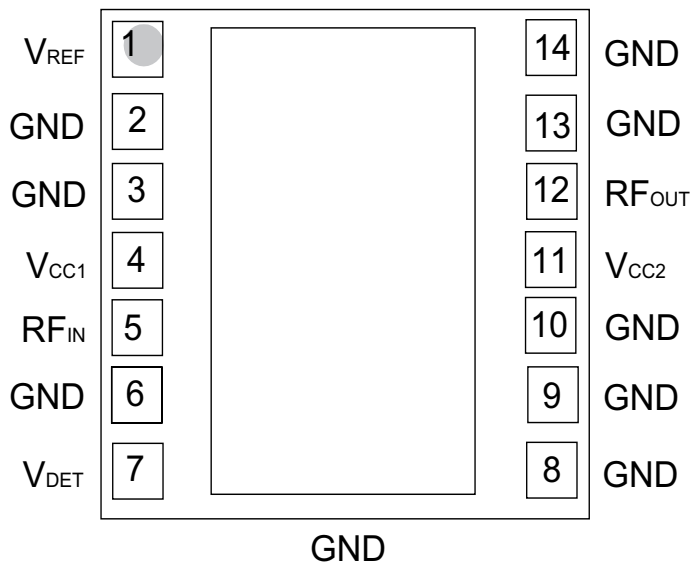

**Figure 2: Pinout (X-ray Top View)**

**Table 1: Pin Description**

PIN	NAME	DESCRIPTION
1	$V_{REF}$	Reference Voltage
2	GND	Ground
3	GND	Ground
4	$V_{CC1}$	Supply Voltage
5	$RF_{IN}$	RF Input
6	GND	Ground
7	$V_{DET}$	Detector Voltage
8	GND	Ground
9	GND	Ground
10	GND	Ground
11	$V_{CC2}$	Supply Voltage
12	$RF_{OUT}$	RF Output
13	GND	Ground
14	GND	Ground

## ELECTRICAL CHARACTERISTICS

Table 2: Absolute Minimum and Maximum Ratings

PARAMETER	MIN	MAX	UNIT
Supply Voltage ( $V_{CC}$ )	0	+5	V
Reference Voltage ( $V_{REF}$ )	0	+3.5	V
RF Output Power ( $P_{OUT}$ )	-	+28	dBm, modulated
RF Input Power ( $P_{IN}$ )	-	+10	dBm, CW
ESD Rating Human Body Model <sup>(1)</sup> Charged Device Model <sup>(2)</sup>	Class 1C Class IV	- -	
MSL Rating <sup>(3)</sup>	4	-	
Junction Temperature ( $T_J$ )	-	+150	°C
Storage Temperature ( $T_{STG}$ )	-40	+150	°C

Functional operation is not implied under these conditions. Exceeding any one or a combination of the Absolute Maximum Rating Conditions may cause permanent damage to the device. Exposure to absolute ratings for extended periods of time may adversely affect reliability.

Notes:

(1) JEDEC JS-001-2010.

(2) JEDEC JESD22-C101D.

(3) 260 °C peak reflow.

Table 3: Operating Ranges

PARAMETER	MIN	TYP	MAX	UNIT	COMMENTS
Operating Frequency (f)	1805	-	1880	MHz	
Supply Voltage ( $V_{CC}$ )	+3.2	+4.2	+4.5	V	
Reference Voltage ( $V_{REF}$ )	+2.80 0	+2.85 -	+2.90 +0.5	V	PA "on" PA "shut down"
RF Output Power ( $P_{OUT}$ ) <sup>(1)</sup>	-	+24.5	-	dBm	
Case Temperature ( $T_C$ ) <sup>(2)</sup>	-40	-	+85	°C	

The device may be operated safely over these conditions; however, parametric performance is guaranteed only over the conditions defined in the electrical specifications.

Notes:

(1) Typ RF Output Power is used during production test.

(2) Case Temperature references the board temperature at the ground paddle on the backside of the package.

**Table 4: Electrical Specifications**  
 (T<sub>C</sub> = +25 °C, V<sub>CC</sub> = +4.2 V, V<sub>REF</sub> = +2.85 V, 50 Ω system)

PARAMETER	MIN	TYP	MAX	UNIT	COMMENTS
Gain <sup>(2)</sup>	30	32	36	dB	
ACPR <sup>(1), (2), (3)</sup> @ 10 MHz @ 20 MHz	- -	-47 -57	-45 -55	dBc	
Power-Added Efficiency <sup>(1), (2), (3)</sup>	14.5	16	-	%	
Thermal Resistance	-	23.8	-	°C/W	Junction to case
Supply Current <sup>(1), (2), (3)</sup>	-	390	463	mA	Total through V <sub>CC</sub> pins
Quiescent Current (I <sub>cq</sub> )	-	135	175	mA	
Reference Current	-	6.5	10	mA	through V <sub>REF</sub> pin
Leakage Current	-	1.5	5	μA	V <sub>CC</sub> = +4.5 V, V <sub>REF</sub> = 0 V
Harmonics 2fo 3fo 4fo	- - -	-56 -65 -65	-48 -57 -57	dBc	
Input Return Loss	10	14	-	dB	
P1dB	-	32	-	dBm	
Spurious Output Level (all spurious outputs)	-	-	-60	dBc	P <sub>OUT</sub> ≤ +24.5 dBm In-band load VSWR < 5:1 Out-of-band load VSWR < 10:1 Applies over all voltage and temperature operating ranges
Load mismatch stress with no permanent degradation or failure	8:1	-	-	VSWR	V <sub>CC</sub> = +4.2 V, P <sub>IN</sub> = 0 dBm Applies over full operating temperature range

## Notes:

(1) ACPR and Efficiency measured at 1842.5 MHz.

(2) P<sub>OUT</sub> = +24.5 dBm.

(3) LTE E-TM1.1 (10 MHz)

**APPLICATION INFORMATION**

To ensure proper performance, refer to all related Application Notes on the ANADIGICS web site: <http://www.anadigics.com>

**Shutdown Mode**

The power amplifier may be placed in a shutdown mode by applying logic low levels (see Operating Ranges table) to the V<sub>REF</sub> voltage.

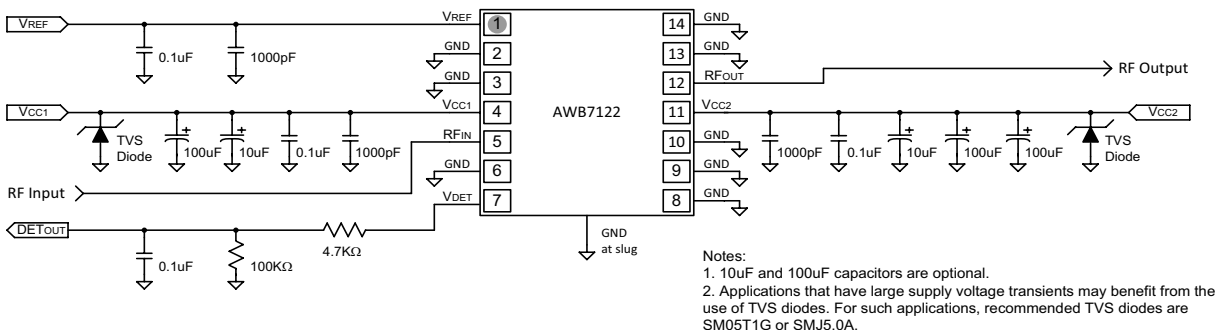

**Figure 3: Application Circuit Schematic**

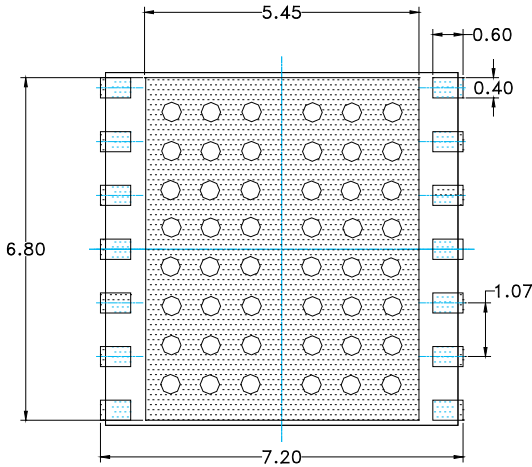

NOTES:

- (1) UNLESS SPECIFIED DIMENSIONS ARE SYMMETRICAL ABOUT CENTER LINES SHOWN.
- (2) DIMENSIONS IN MILLIMETERS.
- (3) VIAS SHOWN IN PCB METAL VIEW ARE FOR REFERENCE ONLY. NUMBER & SIZE OF THERMAL VIAS REQUIRED DEPENDENT ON HEAT DISSIPATION REQUIREMENT AND THE PCB PROCESS CAPABILITY.

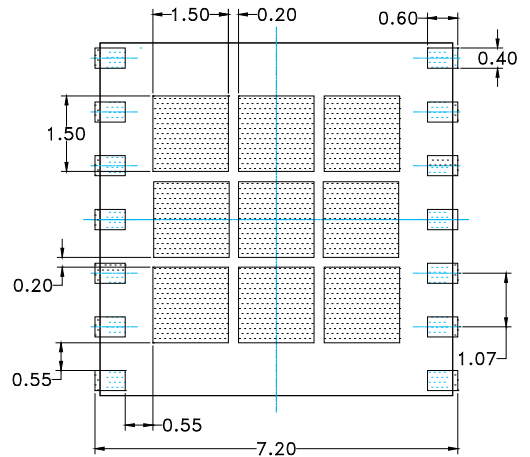
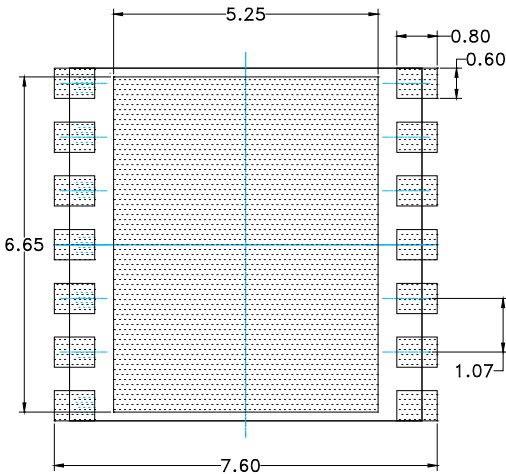
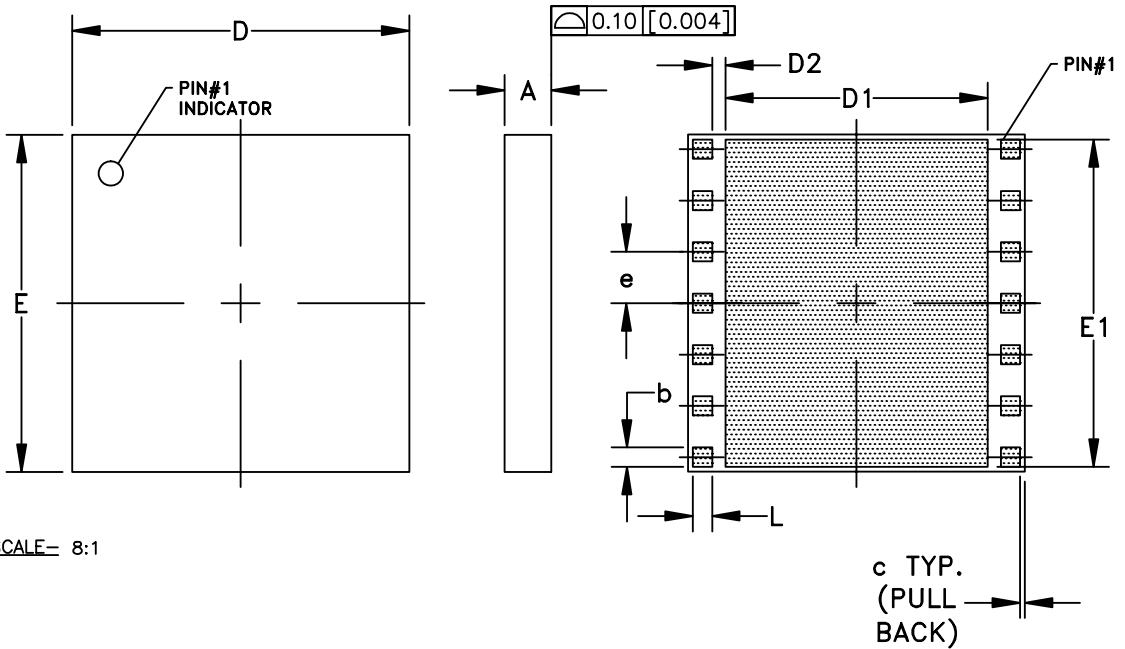

Figure 4: PCB Footprint

PACKAGE OUTLINE



SCALE= 8:1

	MILLIMETERS			INCHES			NOTE
	MIN.	NOM.	MAX.	MIN.	NOM.	MAX.	
A	1.22	1.32	1.42	0.048	0.052	0.056	—
b	0.375	0.400	0.425	0.0148	0.0157	0.0167	14X
c	—	0.10	—	—	0.004	—	—
D	6.90	7.00	7.10	0.272	0.276	0.280	—
D1	—	5.45	—	—	0.215	—	—
D2	—	0.275	—	—	0.0108	—	—
E	6.90	7.00	7.10	0.272	0.276	0.280	—
E1	—	6.80	—	—	0.268	—	—
e	—	1.067	—	—	0.0420	—	6X
L	0.375	0.400	0.425	0.0148	0.0157	0.0167	14X

NOTES:

1. CONTROLLING DIMENSIONS: MILLIMETERS
2. UNLESS SPECIFIED TOLERANCE=±0.076[0.003].
3. PADS (INCLUDING CENTER) SHOWN UNIFORM SIZE FOR REFERENCE ONLY. ACTUAL PAD SIZE AND LOCATION WILL VARY WITHIN MIN. AND MAX. DIMENSIONS ACCORDING TO SPECIFIC LAMINATE DESIGN.

Figure 5: Package Outline - 14 Pin 7 mm x 7 mm x 1.3 mm Surface Mount Module

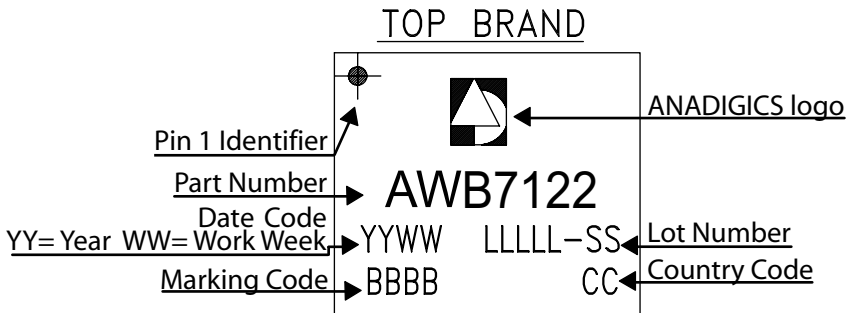

Figure 6: Branding Specification

COMPONENT PACKAGING

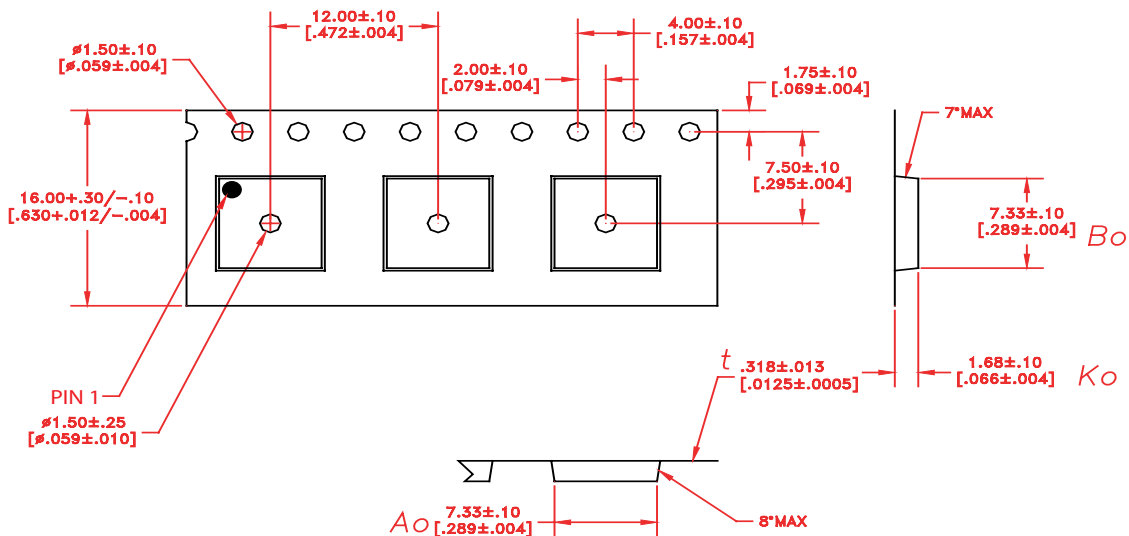

Figure 7: Tape & Reel Packaging

Table 5: Tape & Reel Dimensions

PACKAGE TYPE	TAPE WIDTH	POCKET PITCH	REEL CAPACITY	MAX REEL DIA
7 mm x 7 mm x 1.3 mm	16 mm	12 mm	2500	13"



**ORDERING INFORMATION**

ORDER NUMBER	TEMPERATURE RANGE	PACKAGE DESCRIPTION	COMPONENT PACKAGING
AWB7122P7	-40 °C to +85 °C	RoHS-compliant 14 Pin 7 mm x 7 mm x 1.3 mm Surface Mount Module	Loose in Bag
AWB7122P8	-40 °C to +85 °C	RoHS-compliant 14 Pin 7 mm x 7 mm x 1.3 mm Surface Mount Module	Tape and Reel, 2500 pieces per Reel
AWB7122P9	-40 °C to +85 °C	RoHS-compliant 14 Pin 7 mm x 7 mm x 1.3 mm Surface Mount Module	Partial Reel



**ANADIGICS**

141 Mount Bethel Road  
Warren, New Jersey 07059, U.S.A.  
Tel: +1 (908) 668-5000  
Fax: +1 (908) 668-5132

URL: <http://www.anadigics.com>

**IMPORTANT NOTICE**

ANADIGICS, Inc. reserves the right to make changes to its products or to discontinue any product at any time without notice. The product specifications contained in Advanced Product Information sheets and Preliminary Data Sheets are subject to change prior to a product's formal introduction. Information in Data Sheets have been carefully checked and are assumed to be reliable; however, ANADIGICS assumes no responsibilities for inaccuracies. ANADIGICS strongly urges customers to verify that the information they are using is current before placing orders.

**WARNING**

ANADIGICS products are not intended for use in life support appliances, devices or systems. Use of an ANADIGICS product in any such application without written consent is prohibited.