

30V Input, 100mA Current Limit, Micropower Linear Regulator

UM1431S-xx SOT23-3
UM1431S5-xx/UM1441S -xx SOT23-5
UM1431Y-xx/UM1431B-xx SOT89-3
UM1441Y-xx SOT89-5

General Description

The UM1431/1441 series are high input voltage low quiescent current regulators implemented in CMOS technology. It can accept input voltage as high as 30V with 100mA output current limit. The output voltages are selectable in 100mV steps within a range of 2.0V to 6.0V. 100mA output current limiting is built in to provide protection for the regulators against fault conditions. CMOS technology ensures low voltage drop and low quiescent current.

With a chip enable control pin, the UM1441 can turn off the output and greatly reduce the power consumption by setting the enable pin low.

The UM1431 is available in SOT23-3, SOT23-5 and SOT89-3 packages. The UM1441 is available in SOT23-5 and SOT89-5 packages.

Applications

- Communication Equipment
- Audio/Video Equipment
- Industrial Control
- Infotainment

Features

- Input Voltage Range: 3.6V to 30V
- 100mA Output Current Limit
- $\pm 3\%$ Voltage Accuracy at 30mA
- Low Dropout Voltage:
250mV (Typical) at 30mA
- Low Quiescent Current:
5.8 μ A @ $V_{IN}=30V$ (Typical)
- Available Fixed Output Voltage from 2.0V to 6.0V with 0.1V Step
- With Enable Control (UM1441S-xx, UM1441Y-xx)
- Output Current Limit
- UM1431: Low Profile SOT23-3, SOT23-5 and SOT89-3 Packages
UM1441: Low Profile SOT23-5 and SOT89-5 Packages

Typical Application Circuit

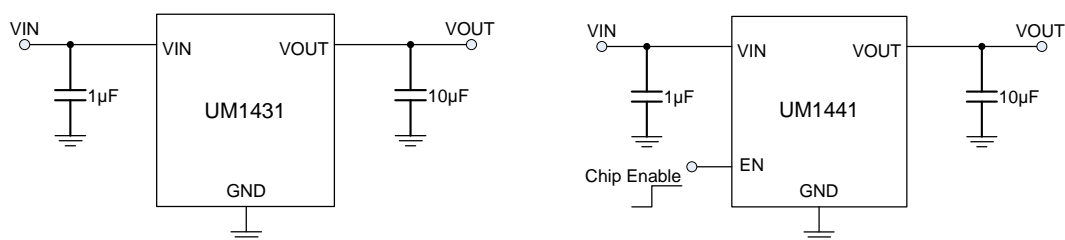

Pin Configurations

Top View

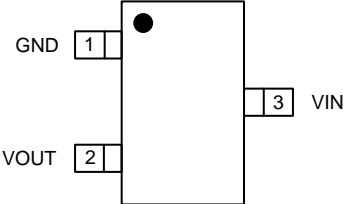
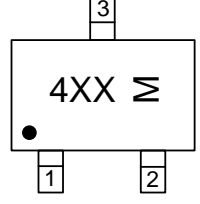
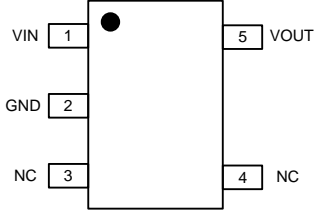
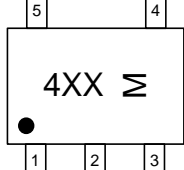
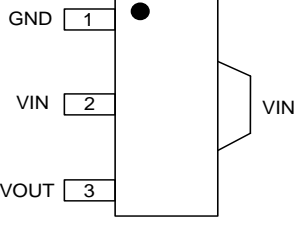
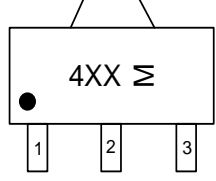
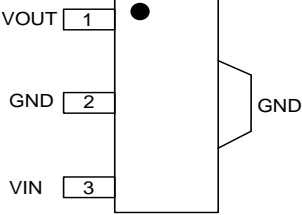
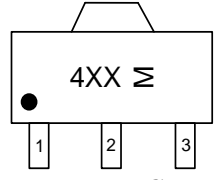
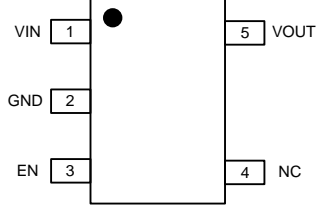
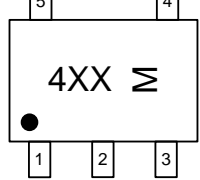
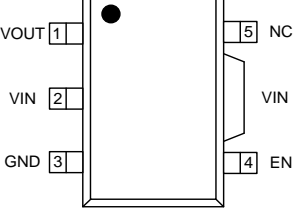
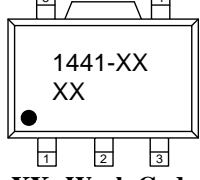
 <p>UM1431S-xx SOT23-3</p>	 <p>M: Month Code UM1431S-xx SOT23-3</p>
 <p>UM1431S5-xx SOT23-5</p>	 <p>M: Month Code UM1431S5-xx SOT23-5</p>
 <p>UM1431Y-xx SOT89-3</p>	 <p>M: Month Code UM1431Y-xx SOT89-3</p>
 <p>UM1431B-xx SOT89-3</p>	 <p>M: Month Code UM1431B-xx SOT89-3</p>
 <p>UM1441S-xx SOT23-5</p>	 <p>M: Month Code UM1441S-xx SOT23-5</p>
 <p>UM1441Y-xx SOT89-5</p>	 <p>XX: Week Code UM1441Y-xx SOT89-5</p>

Pin Description

Pin Name	Pin Function
EN	Enable Input: High=Activate LDO, Low=Shutdown LDO
GND	Ground
VIN	Supply Input
VOUT	Voltage Regulated Output
NC	Not Connected

Naming Information

UM1431/1441 □ □ - □ □

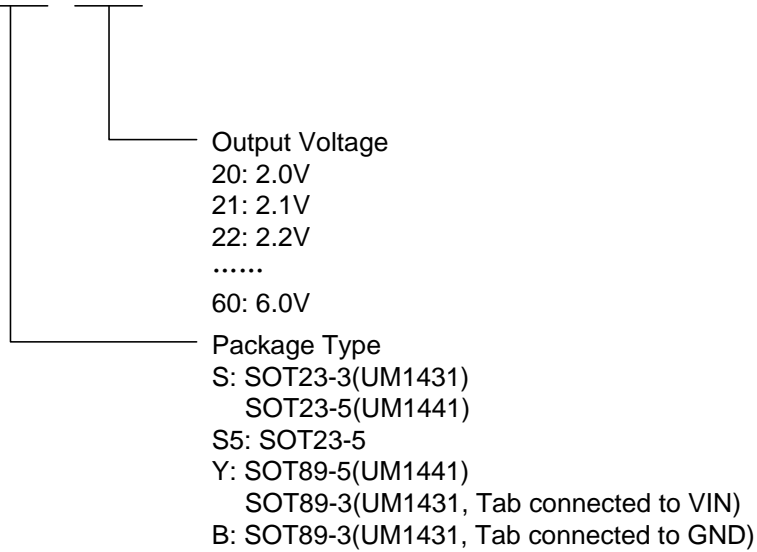

Ordering Information

Part Number	Output Voltage	Packaging Type	Marking Code	Shipping Qty
UM1431S-20	2.0V	SOT23-3	4KA	3000pcs/7Inch Tape & Reel
UM1431S-21	2.1V		4KB	
UM1431S-22	2.2V		4K2	
UM1431S-23	2.3V		4K3	
UM1431S-24	2.4V		4K4	
UM1431S-25	2.5V		4K5	
UM1431S-26	2.6V		4K6	
UM1431S-27	2.7V		4K7	
UM1431S-28	2.8V		4K8	
UM1431S-29	2.9V		4K9	
UM1431S-30	3.0V		4KC	
UM1431S-31	3.1V		4KD	
UM1431S-32	3.2V		4KE	
UM1431S-33	3.3V		4KF	
UM1431S-34	3.4V		4KH	
UM1431S-35	3.5V		4KL	
UM1431S-36	3.6V		4KM	
UM1431S-37	3.7V		4KJ	
UM1431S-38	3.8V		4KK	
UM1431S-39	3.9V		4KN	
UM1431S-40	4.0V		4KP	
UM1431S-41	4.1V		4KQ	
UM1431S-42	4.2V		4KR	
UM1431S-43	4.3V		4KS	
UM1431S-44	4.4V		4KT	
UM1431S-45	4.5V		4KY	
UM1431S-46	4.6V		4KU	
UM1431S-47	4.7V		4KZ	
UM1431S-48	4.8V		4NA	
UM1431S-49	4.9V		4NB	
UM1431S-50	5.0V		4NC	
UM1431S-51	5.1V		4ND	
UM1431S-52	5.2V		4N2	
UM1431S-53	5.3V		4N3	
UM1431S-54	5.4V		4N4	
UM1431S-55	5.5V		4N5	
UM1431S-56	5.6V		4N6	
UM1431S-57	5.7V		4N7	
UM1431S-58	5.8V		4N8	
UM1431S-59	5.9V		4N9	
UM1431S-60	6.0V		4NE	

Ordering Information (Continued)

Part Number	Output Voltage	Packaging Type	Marking Code	Shipping Qty
UM1431S5-20	2.0V	SOT23-5	4PA	3000pcs/7Inch Tape & Reel
UM1431S5-21	2.1V		4PB	
UM1431S5-22	2.2V		4P2	
UM1431S5-23	2.3V		4P3	
UM1431S5-24	2.4V		4P4	
UM1431S5-25	2.5V		4P5	
UM1431S5-26	2.6V		4P6	
UM1431S5-27	2.7V		4P7	
UM1431S5-28	2.8V		4P8	
UM1431S5-29	2.9V		4P9	
UM1431S5-30	3.0V		4PC	
UM1431S5-31	3.1V		4PD	
UM1431S5-32	3.2V		4PE	
UM1431S5-33	3.3V		4PF	
UM1431S5-34	3.4V		4PH	
UM1431S5-35	3.5V		4PL	
UM1431S5-36	3.6V		4PM	
UM1431S5-37	3.7V		4PJ	
UM1431S5-38	3.8V		4PK	
UM1431S5-39	3.9V		4PN	
UM1431S5-40	4.0V		4PP	
UM1431S5-41	4.1V		4PQ	
UM1431S5-42	4.2V		4PR	
UM1431S5-43	4.3V		4PS	
UM1431S5-44	4.4V		4PT	
UM1431S5-45	4.5V		4PY	
UM1431S5-46	4.6V		4PU	
UM1431S5-47	4.7V		4PZ	
UM1431S5-48	4.8V		4QA	
UM1431S5-49	4.9V		4QB	
UM1431S5-50	5.0V		4QC	
UM1431S5-51	5.1V		4QD	
UM1431S5-52	5.2V		4Q2	
UM1431S5-53	5.3V		4Q3	
UM1431S5-54	5.4V		4Q4	
UM1431S5-55	5.5V		4Q5	
UM1431S5-56	5.6V		4Q6	
UM1431S5-57	5.7V		4Q7	
UM1431S5-58	5.8V		4Q8	
UM1431S5-59	5.9V		4Q9	
UM1431S5-60	6.0V		4QE	

Ordering Information (Continued)

Part Number	Output Voltage	Packaging Type	Marking Code	Shipping Qty
UM1431Y-20	2.0V	SOT89-3 (Tab connected to VIN)	4RA	1000pcs/7Inch Tape & Reel
UM1431Y-21	2.1V		4RB	
UM1431Y-22	2.2V		4R2	
UM1431Y-23	2.3V		4R3	
UM1431Y-24	2.4V		4R4	
UM1431Y-25	2.5V		4R5	
UM1431Y-26	2.6V		4R6	
UM1431Y-27	2.7V		4R7	
UM1431Y-28	2.8V		4R8	
UM1431Y-29	2.9V		4R9	
UM1431Y-30	3.0V		4RC	
UM1431Y-31	3.1V		4RD	
UM1431Y-32	3.2V		4RE	
UM1431Y-33	3.3V		4RF	
UM1431Y-34	3.4V		4RH	
UM1431Y-35	3.5V		4RL	
UM1431Y-36	3.6V		4RM	
UM1431Y-37	3.7V		4RJ	
UM1431Y-38	3.8V		4RK	
UM1431Y-39	3.9V		4RN	
UM1431Y-40	4.0V		4RP	
UM1431Y-41	4.1V		4RQ	
UM1431Y-42	4.2V		4RR	
UM1431Y-43	4.3V		4RS	
UM1431Y-44	4.4V		4RT	
UM1431Y-45	4.5V		4RY	
UM1431Y-46	4.6V		4RU	
UM1431Y-47	4.7V		4RZ	
UM1431Y-48	4.8V		4FF	
UM1431Y-49	4.9V		4FH	
UM1431Y-50	5.0V		4FL	
UM1431Y-51	5.1V		4FM	
UM1431Y-52	5.2V		4FJ	
UM1431Y-53	5.3V		4FK	
UM1431Y-54	5.4V		4FN	
UM1431Y-55	5.5V		4FP	
UM1431Y-56	5.6V		4FQ	
UM1431Y-57	5.7V		4FR	
UM1431Y-58	5.8V		4FS	
UM1431Y-59	5.9V		4FT	
UM1431Y-60	6.0V		4FY	

Ordering Information (Continued)

Part Number	Output Voltage	Packaging Type	Marking Code	Shipping Qty
UM1431B-20	2.0V	SOT89-3 (Tab connected to GND)	4SA	1000pcs/7Inch Tape & Reel
UM1431B-21	2.1V		4SB	
UM1431B-22	2.2V		4S2	
UM1431B-23	2.3V		4S3	
UM1431B-24	2.4V		4S4	
UM1431B-25	2.5V		4S5	
UM1431B-26	2.6V		4S6	
UM1431B-27	2.7V		4S7	
UM1431B-28	2.8V		4S8	
UM1431B-29	2.9V		4S9	
UM1431B-30	3.0V		4SC	
UM1431B-31	3.1V		4SD	
UM1431B-32	3.2V		4SE	
UM1431B-33	3.3V		4SF	
UM1431B-34	3.4V		4SH	
UM1431B-35	3.5V		4SL	
UM1431B-36	3.6V		4SM	
UM1431B-37	3.7V		4SJ	
UM1431B-38	3.8V		4SK	
UM1431B-39	3.9V		4SN	
UM1431B-40	4.0V		4SP	
UM1431B-41	4.1V		4SQ	
UM1431B-42	4.2V		4SR	
UM1431B-43	4.3V		4SS	
UM1431B-44	4.4V		4ST	
UM1431B-45	4.5V		4SY	
UM1431B-46	4.6V		4SU	
UM1431B-47	4.7V		4SZ	
UM1431B-48	4.8V		4JF	
UM1431B-49	4.9V		4JH	
UM1431B-50	5.0V		4JL	
UM1431B-51	5.1V		4JM	
UM1431B-52	5.2V		4JJ	
UM1431B-53	5.3V		4JK	
UM1431B-54	5.4V		4JN	
UM1431B-55	5.5V		4JP	
UM1431B-56	5.6V		4JQ	
UM1431B-57	5.7V		4JR	
UM1431B-58	5.8V		4JS	
UM1431B-59	5.9V		4JT	
UM1431B-60	6.0V		4JY	

Ordering Information (Continued)

Part Number	Output Voltage	Packaging Type	Marking Code	Shipping Qty
UM1441S-20	2.0V	SOT23-5	4TA	3000pcs/7Inch Tape & Reel
UM1441S-21	2.1V		4TB	
UM1441S-22	2.2V		4T2	
UM1441S-23	2.3V		4T3	
UM1441S-24	2.4V		4T4	
UM1441S-25	2.5V		4T5	
UM1441S-26	2.6V		4T6	
UM1441S-27	2.7V		4T7	
UM1441S-28	2.8V		4T8	
UM1441S-29	2.9V		4T9	
UM1441S-30	3.0V		4TC	
UM1441S-31	3.1V		4TD	
UM1441S-32	3.2V		4TE	
UM1441S-33	3.3V		4TF	
UM1441S-34	3.4V		4TH	
UM1441S-35	3.5V		4TL	
UM1441S-36	3.6V		4TM	
UM1441S-37	3.7V		4TJ	
UM1441S-38	3.8V		4TK	
UM1441S-39	3.9V		4TN	
UM1441S-40	4.0V		4TP	
UM1441S-41	4.1V		4TQ	
UM1441S-42	4.2V		4TR	
UM1441S-43	4.3V		4TS	
UM1441S-44	4.4V		4TT	
UM1441S-45	4.5V		4TY	
UM1441S-46	4.6V		4TU	
UM1441S-47	4.7V		4TZ	
UM1441S-48	4.8V		4QF	
UM1441S-49	4.9V		4QH	
UM1441S-50	5.0V		4QL	
UM1441S-51	5.1V		4QM	
UM1441S-52	5.2V		4QJ	
UM1441S-53	5.3V		4QK	
UM1441S-54	5.4V		4QN	
UM1441S-55	5.5V		4QP	
UM1441S-56	5.6V		4QQ	
UM1441S-57	5.7V		4QR	
UM1441S-58	5.8V		4QS	
UM1441S-59	5.9V		4QT	
UM1441S-60	6.0V		4QY	

Ordering Information (Continued)

Part Number	Output Voltage	Packaging Type	Marking Code	Shipping Qty
UM1441Y-20	2.0V	SOT89-5	1441-20	1000pcs/7Inch Tape & Reel
UM1441Y-21	2.1V		1441-21	
UM1441Y-22	2.2V		1441-22	
UM1441Y-23	2.3V		1441-23	
UM1441Y-24	2.4V		1441-24	
UM1441Y-25	2.5V		1441-25	
UM1441Y-26	2.6V		1441-26	
UM1441Y-27	2.7V		1441-27	
UM1441Y-28	2.8V		1441-28	
UM1441Y-29	2.9V		1441-29	
UM1441Y-30	3.0V		1441-30	
UM1441Y-31	3.1V		1441-31	
UM1441Y-32	3.2V		1441-32	
UM1441Y-33	3.3V		1441-33	
UM1441Y-34	3.4V		1441-34	
UM1441Y-35	3.5V		1441-35	
UM1441Y-36	3.6V		1441-36	
UM1441Y-37	3.7V		1441-37	
UM1441Y-38	3.8V		1441-38	
UM1441Y-39	3.9V		1441-39	
UM1441Y-40	4.0V		1441-40	
UM1441Y-41	4.1V		1441-41	
UM1441Y-42	4.2V		1441-42	
UM1441Y-43	4.3V		1441-43	
UM1441Y-44	4.4V		1441-44	
UM1441Y-45	4.5V		1441-45	
UM1441Y-46	4.6V		1441-46	
UM1441Y-47	4.7V		1441-47	
UM1441Y-48	4.8V		1441-48	
UM1441Y-49	4.9V		1441-49	
UM1441Y-50	5.0V		1441-50	
UM1441Y-51	5.1V		1441-51	
UM1441Y-52	5.2V		1441-52	
UM1441Y-53	5.3V		1441-53	
UM1441Y-54	5.4V		1441-54	
UM1441Y-55	5.5V		1441-55	
UM1441Y-56	5.6V		1441-56	
UM1441Y-57	5.7V		1441-57	
UM1441Y-58	5.8V		1441-58	
UM1441Y-59	5.9V		1441-59	
UM1441Y-60	6.0V		1441-60	

Absolute Maximum Ratings (Note 1)

Symbol	Parameter		Value	Unit
V _{IN}	Supply Voltage on VIN Pin		-0.3 to +33	V
V _{OUT}	Voltage on VOUT Pin		-0.3 to +33	V
T _J	Operating Junction Temperature (Notes 2, 3)		-40 to +125	°C
T _{STG}	Storage Temperature Range		-65 to +150	°C
T _L	Lead Temperature for Soldering 10 Seconds		+260	°C
P _D (Notes 4)	Power Dissipation@25°C	SOT23-3	0.40	W
		SOT89-3	1.0	
		SOT23-5	0.43	
		SOT89-5	1.20	
θ _{JA}	Package Thermal Resistance	SOT23-3	250	°C/W
		SOT89-3	100	
		SOT23-5	230	
		SOT89-5	83	

Note 1: Absolute Maximum Ratings are those values beyond which the life of a device may be impaired.

Note 2: The UM1431/1441 is tested and specified under pulse load conditions such that $T_J \approx T_A$. Specifications over the -40°C to 125°C operating junction temperature range are assured by design, characterization and correlation with statistical process controls.

Note 3: This IC includes over temperature protection that is intended to protect the device during momentary overload conditions. Junction temperature will exceed 125°C when over temperature protection is active. Continuous operation above the specified maximum operating junction temperature may impair device reliability.

Note 4: The maximum allowable power dissipation of any T_A (ambient temperature) is $P_{D\text{MAX}} = (T_{J\text{MAX}} - T_A) / \theta_{JA}$. Exceeding the maximum allowable power dissipation will result in excessive die temperature and the regulator will go into thermal shutdown.

Electrical Characteristics
 $V_{IN}=V_{OUT}+1V$, $C_{IN}=1\mu F$, $C_{OUT}=10\mu F$, $T_A=25^\circ C$.

Symbol	Parameter	Test Conditions	Min	Typ	Max	Unit
V_{IN}	Input Voltage Range		3.6		30	V
V_{OUT}	Output Voltage Range		2.0		6.0	V
I_Q	Operating Quiescent Current	$I_{OUT}=0mA$, $V_{IN}=30V$		5.8	8.0	μA
		$V_{IN}=30V$, $I_{OUT}=30mA$		70		
I_{SHDN}	Shutdown Leakage Current	$V_{IN}=30V$		2.2	3.0	μA
I_{OUT}	Output Current		30			mA
	Output Voltage Accuracy	$I_{OUT}=30mA$, $T_A=+25^\circ C$	-3		+3	%
ΔV_{DO}	Dropout Voltage	$I_{OUT}=30mA$		250	350	mV
I_{LIMT}	Output Current Limit	$V_{IN}\geq 2.5V$		100		mA
t	Startup Time Response			150		μs
V_{IL}	Enable Input Low Voltage				0.7	V
V_{IH}	Enable Input High Voltage		2.0			V
T_C	Output Voltage Temperature Coefficient	$I_{OUT}=10mA$		150		ppm/ $^\circ C$
	Line Regulation	$V_{OUT}+1V\leq V_{IN}\leq 30V$ ($3.6V\leq V_{IN}$) $I_{OUT}=10mA$		0.05		%/V
	Load Regulation	$V_{IN}=V_{OUT}+1V$ ($3.6V\leq V_{IN}$) $1\mu A\leq I_{OUT}\leq 30mA$		15		mV
	Output Voltage Noise	10Hz to 100kHz $C_{IN}=1\mu F$, $I_{OUT}=100mA$ $V_{OUT}=2.0V$		450		μV_{RMS}
PSRR	Power Supply Ripple Rejection	$V_{IN}=V_{OUT}+1V$ $I_{OUT}=100mA$ ($3.6V\leq V_{IN}$)	f=100Hz		55	dB
			f=1kHz		45	
			f=10kHz		35	

Typical Performance Characteristics

Quiescent Current vs. Input Voltage
UM1431S-36, $I_{OUT}=0mA$

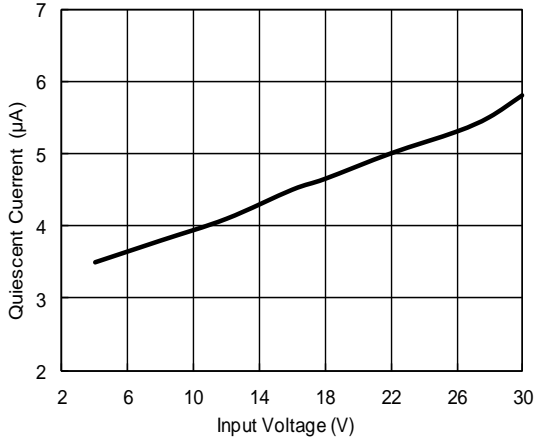

Quiescent Current vs. Temperature
 $V_{IN}=30V, I_{OUT}=0mA$

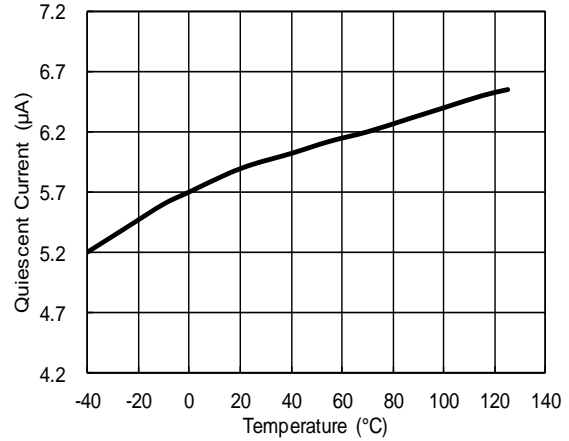

Ground Current vs. Output Current
 $V_{IN}=30V$

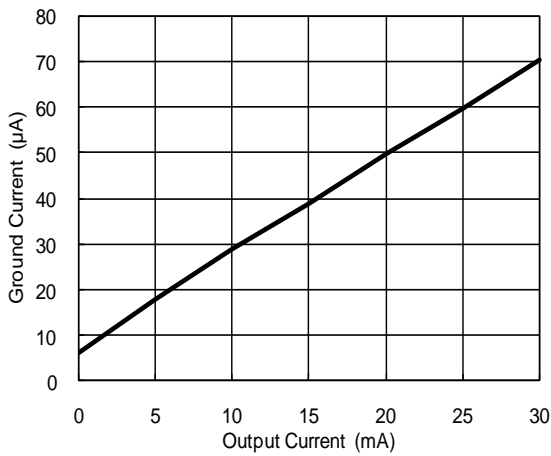

Enable Threshold Voltage vs. Input Voltage

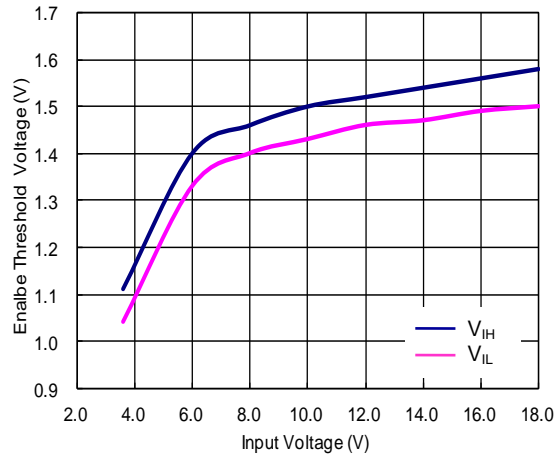

Output Voltage vs. Input Voltage
UM1441S-36

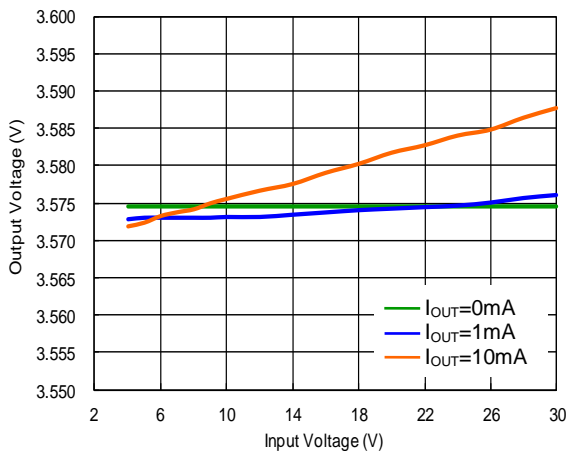

Output Voltage vs. Output Current
UM1441S-36, $V_{IN}=4.0V$

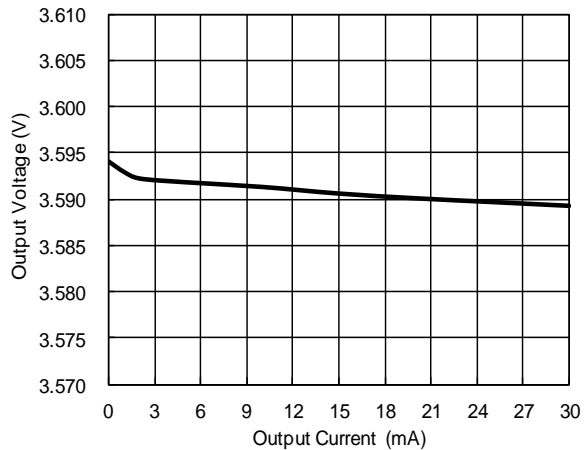

Typical Performance Characteristics (Continued)

Output Voltage vs. Temperature
 $V_{IN}=4.6V, I_{OUT}=2mA$

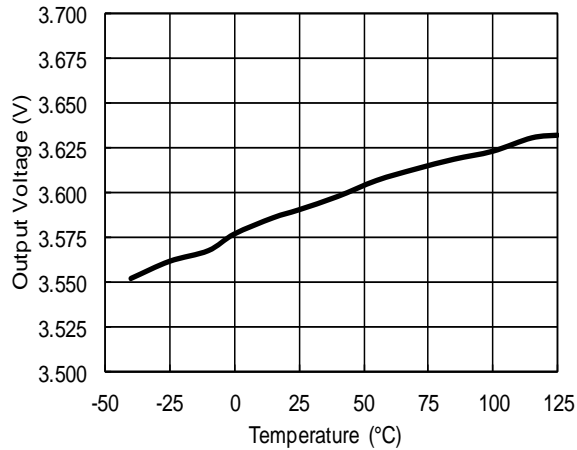

Output Voltage vs. Temperature
 $V_{IN}=30V, I_{OUT}=2mA$

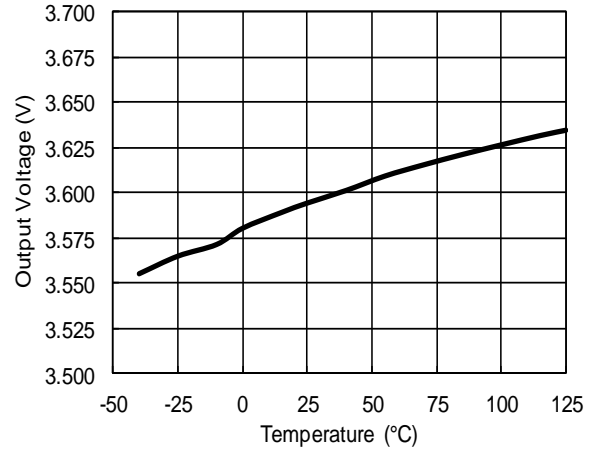

Shutdown Leakage Current vs. Input Voltage

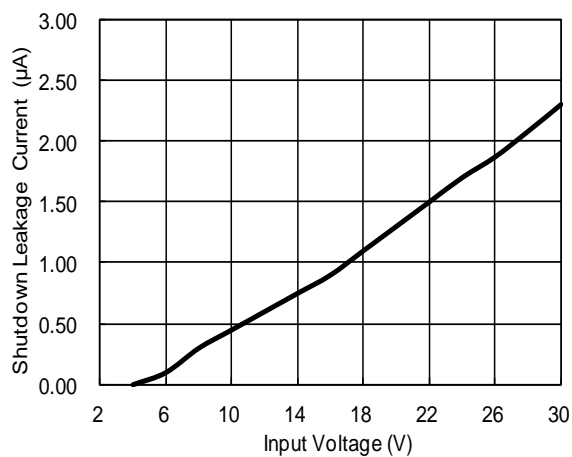

Shutdown Leakage Current vs. Temperature
 $V_{IN}=30V, I_{OUT}=0mA$

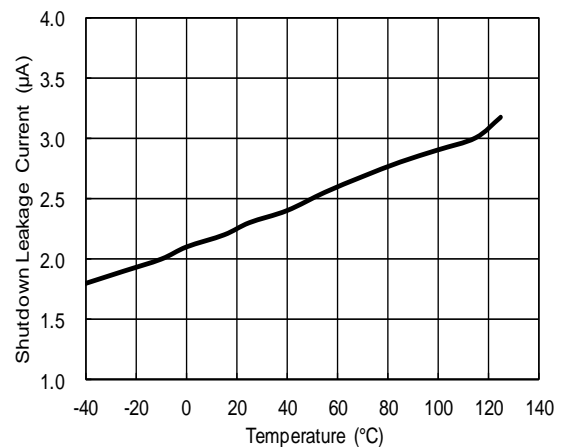

PSRR vs. Frequency

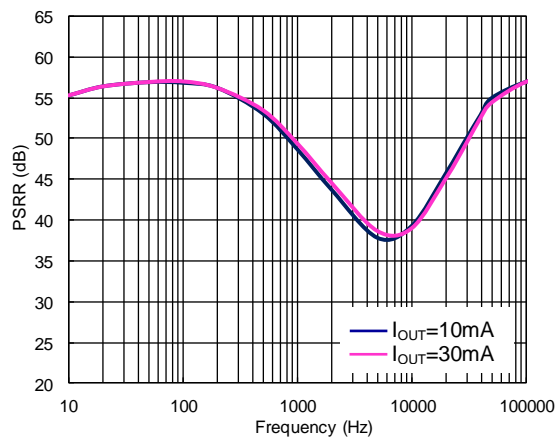

Dropout Voltage vs. Output Current
 UM1431S5-40

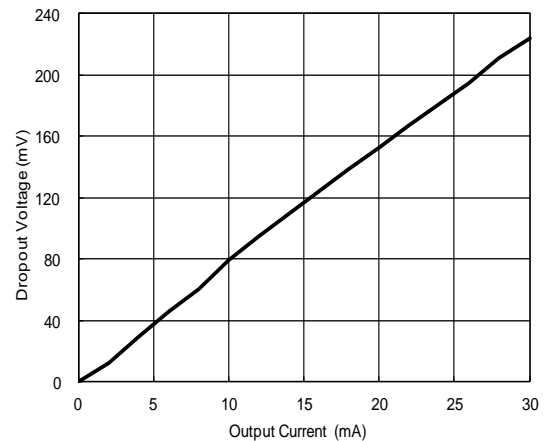

Typical Performance Characteristics (Continued)

Noise

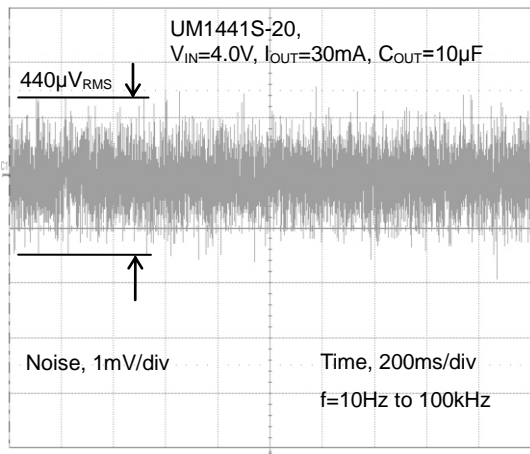

Load Transient Response

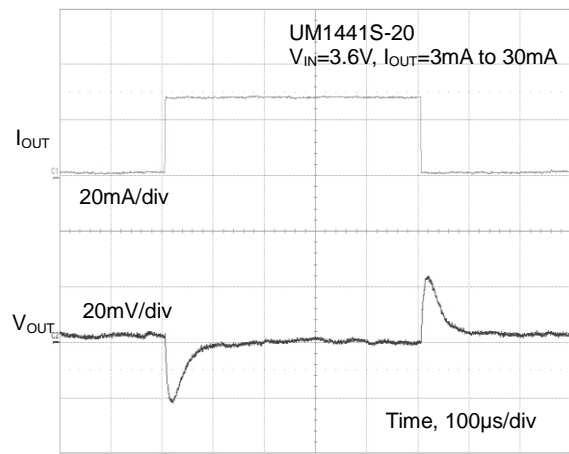

Load Transient Response

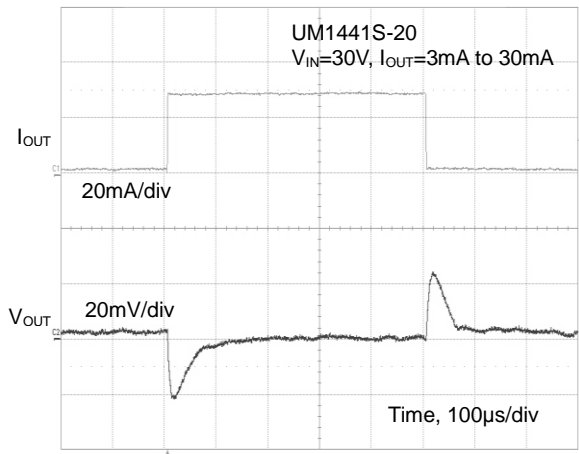

Line Transient Response

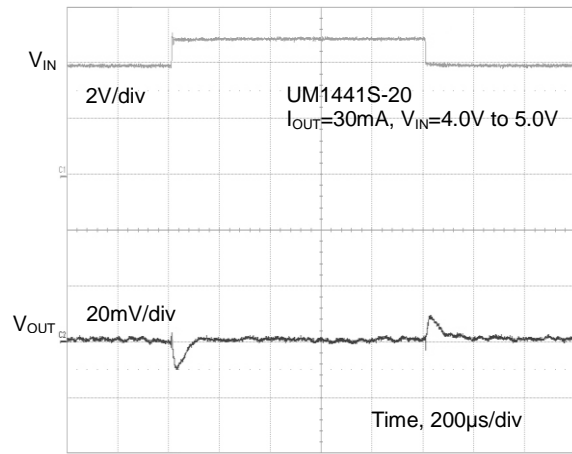

Package Information

UM1431S-xx: SOT23-3

Outline Drawing

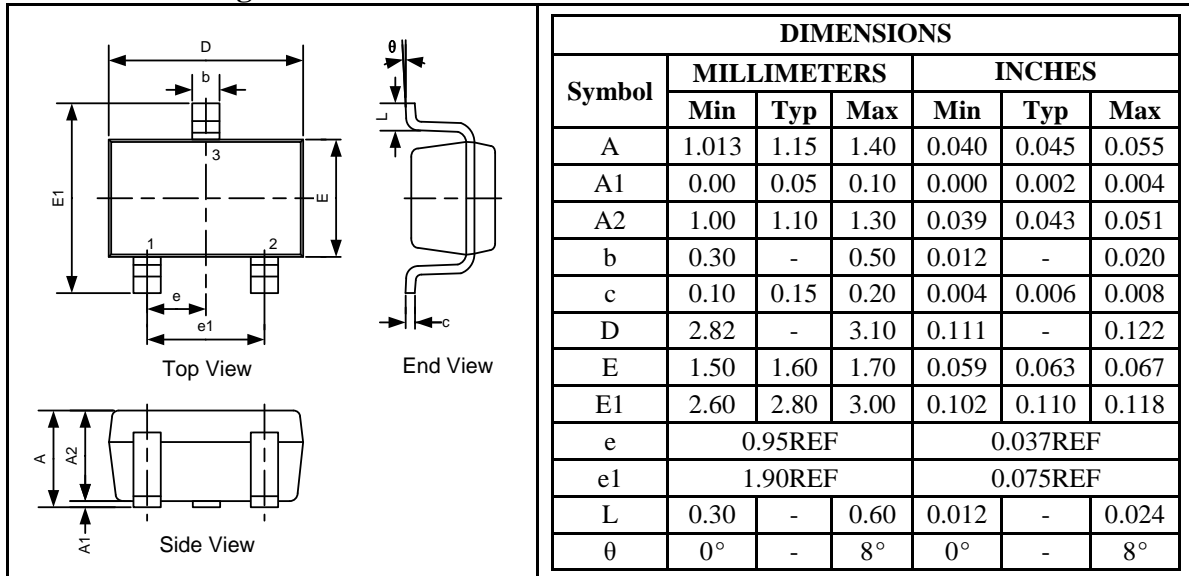

Land Pattern

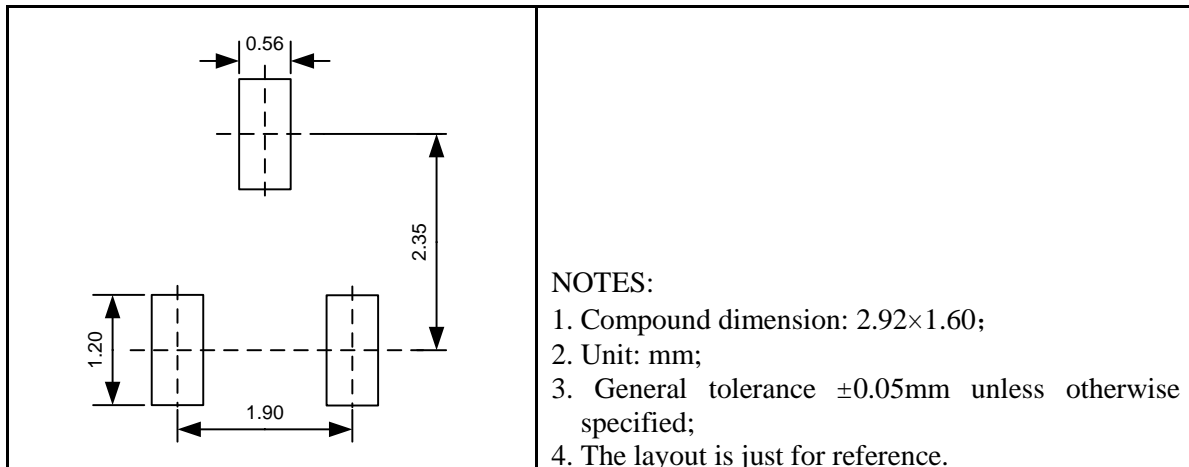

Tape and Reel Orientation

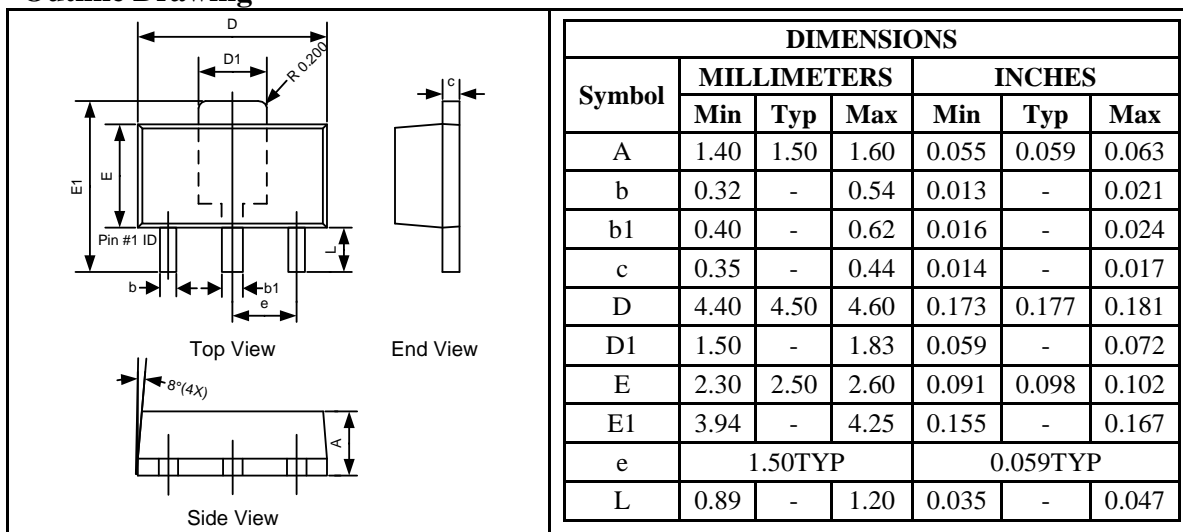
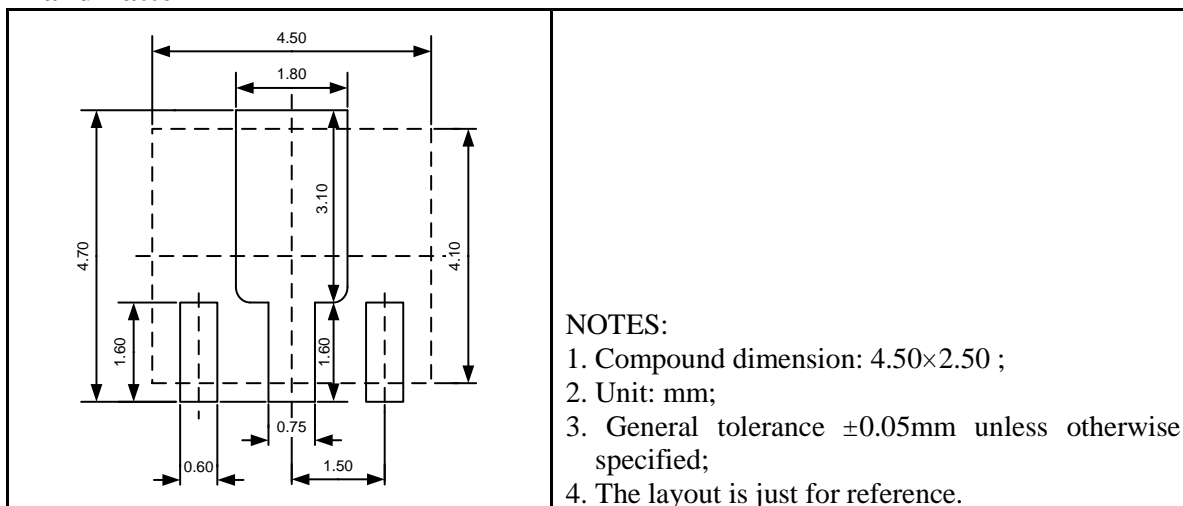
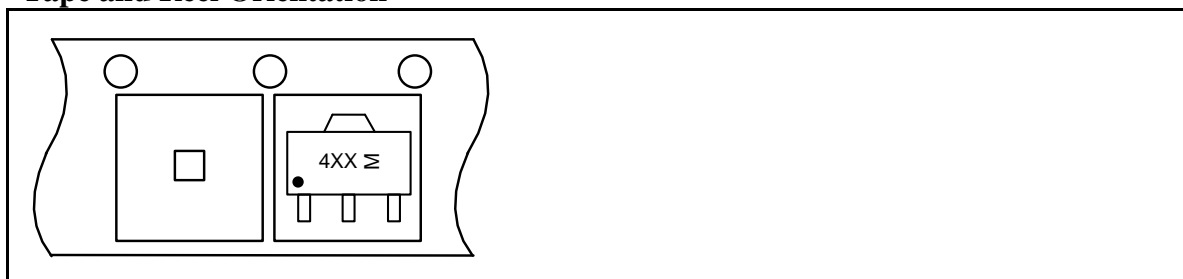

UM1431Y-xx, UM1431B-xx: SOT89-3
Outline Drawing

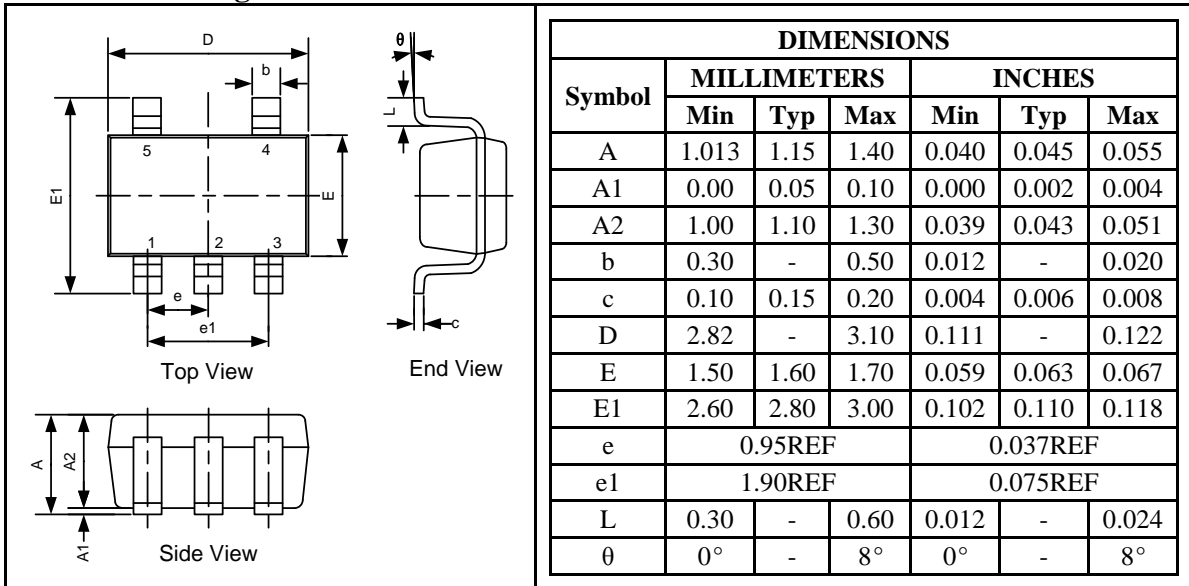
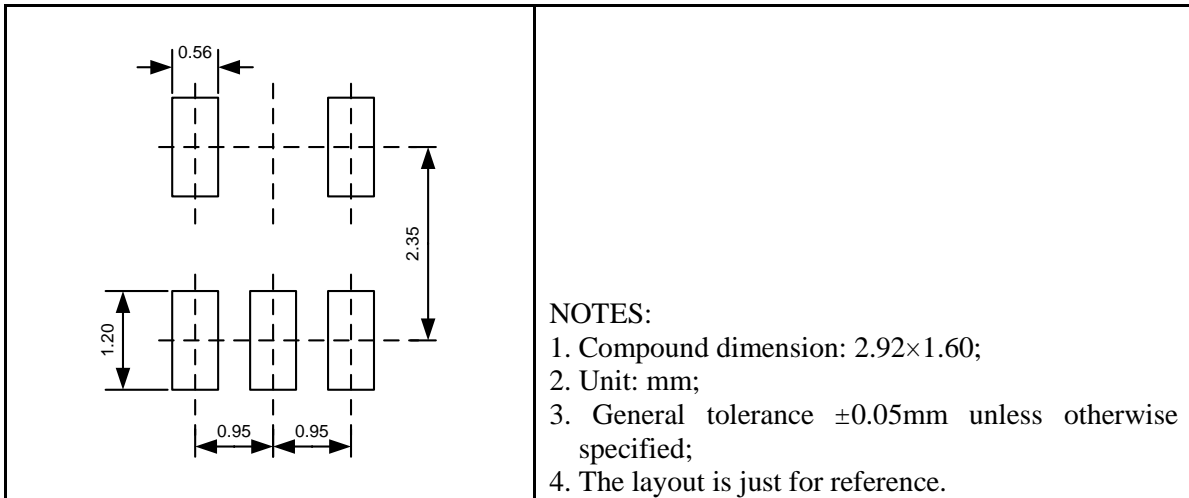
Land Pattern

Tape and Reel Orientation

UM1431S5-xx, UM1441S-xx: SOT23-5
Outline Drawing

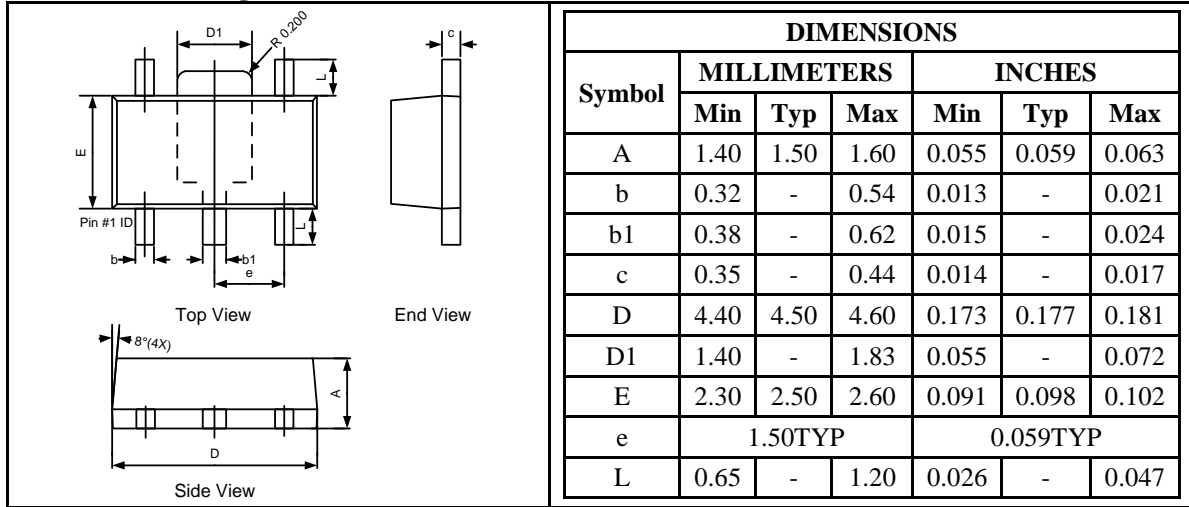
Land Pattern

Tape and Reel Orientation

UM1441Y-xx: SOT89-5

Outline Drawing

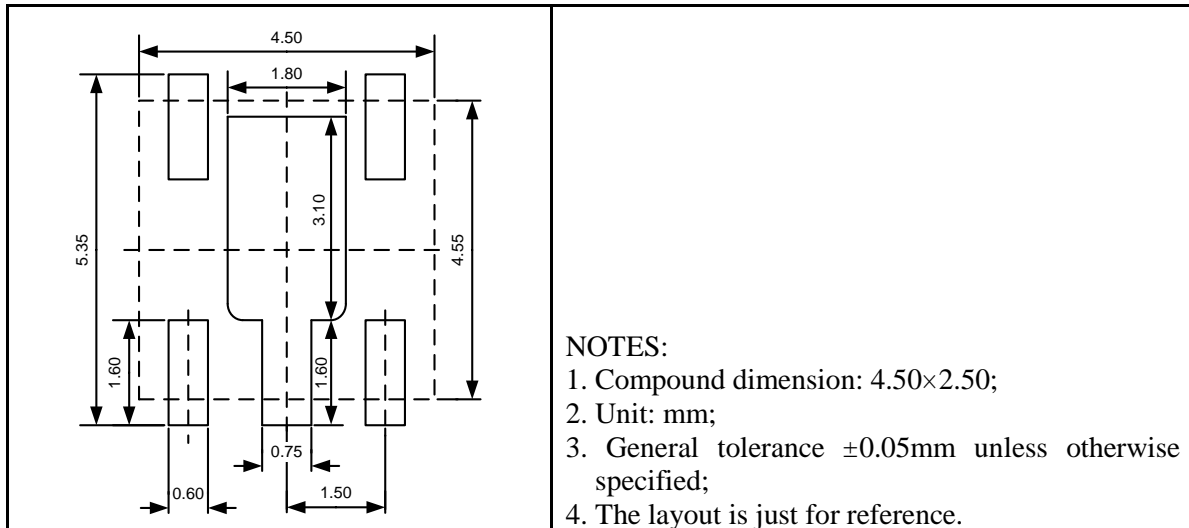

Land Pattern



Tape and Reel Orientation

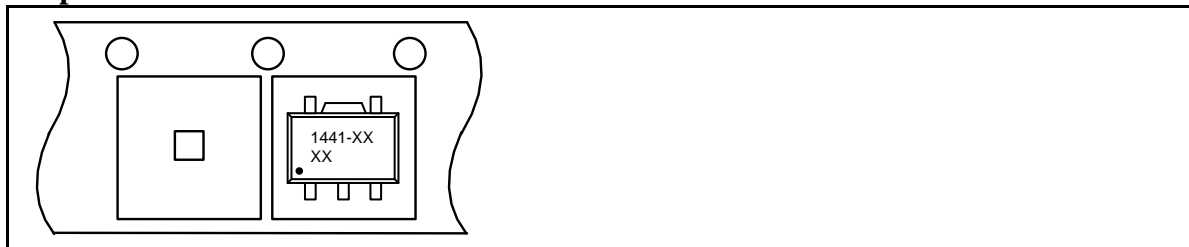

GREEN COMPLIANCE

Union Semiconductor is committed to environmental excellence in all aspects of its operations including meeting or exceeding regulatory requirements with respect to the use of hazardous substances. Numerous successful programs have been implemented to reduce the use of hazardous substances and/or emissions.

All Union components are compliant with the RoHS directive, which helps to support customers in their compliance with environmental directives. For more green compliance information, please visit:

http://www.union-ic.com/index.aspx?cat_code=RoHSDeclaration

IMPORTANT NOTICE

The information in this document has been carefully reviewed and is believed to be accurate. Nonetheless, this document is subject to change without notice. Union assumes no responsibility for any inaccuracies that may be contained in this document, and makes no commitment to update or to keep current the contained information, or to notify a person or organization of any update. Union reserves the right to make changes, at any time, in order to improve reliability, function or design and to attempt to supply the best product possible.



Union Semiconductor, Inc

Add: Unit 606, No.570 Shengxia Road, Shanghai 201210

Tel: 021-51093966

Fax: 021-51026018

Website: www.union-ic.com