

BR10005MSG-G Thru. BR1010MSG-G

Reverse Voltage: 50 to 1000V

Forward Current: 10.0A

RoHS Device

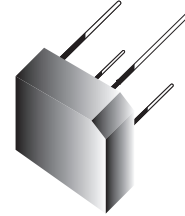

Features

- Low forward voltage drop.
- Small size ; simple installation.
- Sliver plated copper leads.
- Surge overload rating -175 amperes peak.

Mechanical Data

- Polarity: As marked on Body
- Mounting position:Any
- Weight: 3.61 grams

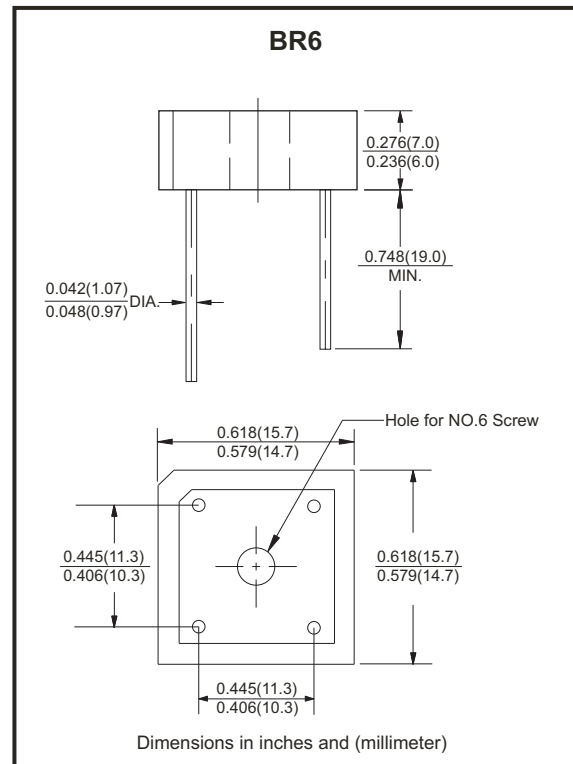

Maximum ratings and electrical characteristics

Rating at 25°C ambient temperature unless otherwise specified.
Single phase, half wave ,60Hz, resistive or inductive load.
For capacitive load, derate current by 20%

Parameter	Symbol	BR10005 MSG-G	BR1001 MSG-G	BR1002 MSG-G	BR1004 MSG-G	BR1006 MSG-G	BR1008 MSG-G	BR1010 MSG-G	Unit
Maximum Recurrent Peak Reverse Voltage	V_{RRM}	50	100	200	400	600	800	1000	V
Maximum RMS Bridge Input Voltage	V_{RMS}	35	70	140	280	420	560	700	V
Maximum DC Blocking Voltage	V_{DC}	50	100	200	400	600	800	1000	V
Maximum Average Forward Rectified Output Current at $T_A=50^\circ\text{C}$	$I_{(AV)}$	10.0							A
Peak Forward Surge Current, 8.3ms Single Half Sine-Wave Super Imposed On Rated Load	I_{FSM}	175							A
Maximum Forward Voltage Drop Per Bridge Element at 5.0A Peak	V_F	1.1							V
Maximum Reverse Current at Rate $T_J=25^\circ\text{C}$ DC Blocking Voltage Per Element $T_J=100^\circ\text{C}$	I_R	10.0							μA
		1.0							mA
Operating Temperature Range	T_J	-55 to +150							$^\circ\text{C}$
Storage Temperature Range	T_{STG}	-55 to +150							$^\circ\text{C}$

Notes:

- Unit mounted on metal chassis.
- Unit mounted on P.C.B.

Company reserves the right to improve product design , functions and reliability without notice.

REV: A

Rating and Characteristics Curves (BR10005MSG-G Thru. BR1010MSG-G)

Fig.1 - Derating Curve Output Rectified Current

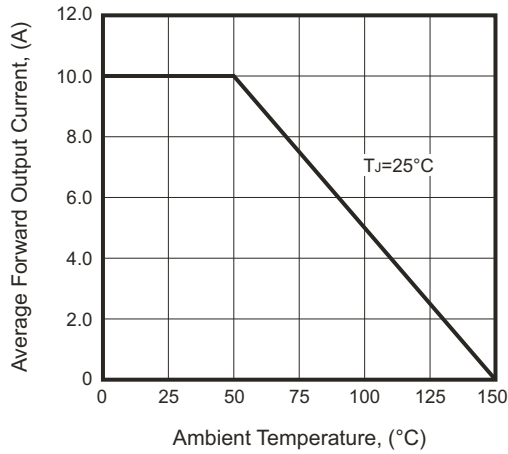

Fig.2 - Maximum Forward Surge Current

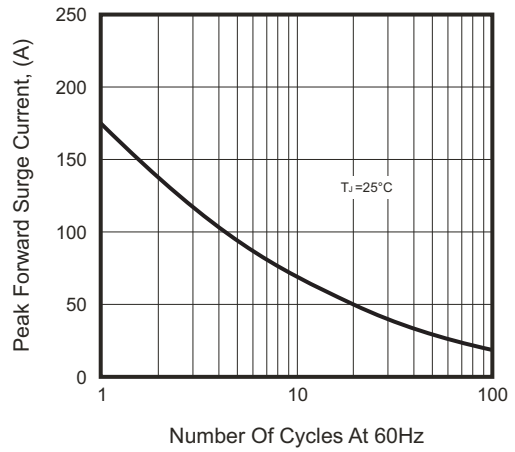

Fig.3 - Typical Forward Characteristics

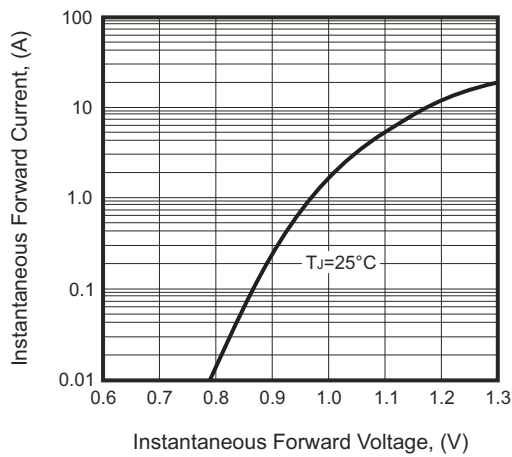
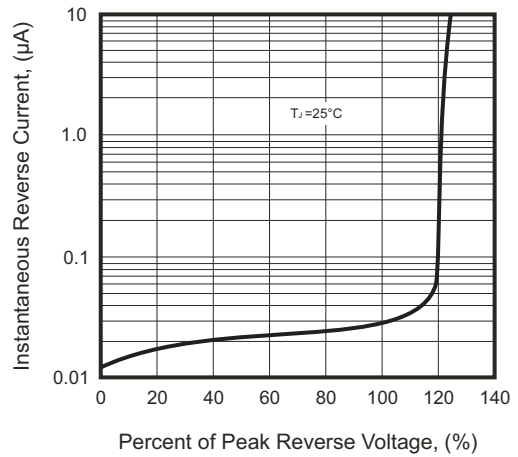
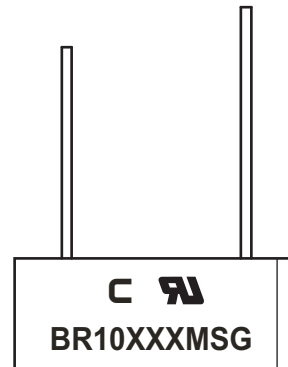

Fig.4 - Typical Reverse Characteristics



Marking Code

Part Number	Marking code
BR10005MSG-G	BR10005MSG
BR1001MSG-G	BR1001MSG
BR1002MSG-G	BR1002MSG
BR1004MSG-G	BR1004MSG
BR1006MSG-G	BR1006MSG
BR1008MSG-G	BR1008MSG
BR1010MSG-G	BR1010MSG



XX / XXX = Product type marking code

C = Compchip Logo

Standard Packaging

Case Type	BULK PACK	
	BOX (pcs)	CARTON (pcs)
BR6	200	2,000