

Keysight Technologies

89601B/BN-200 Basic Vector Signal Analysis

89601B/BN-300 Hardware Connectivity

89600 VSA Software

Technical Overview

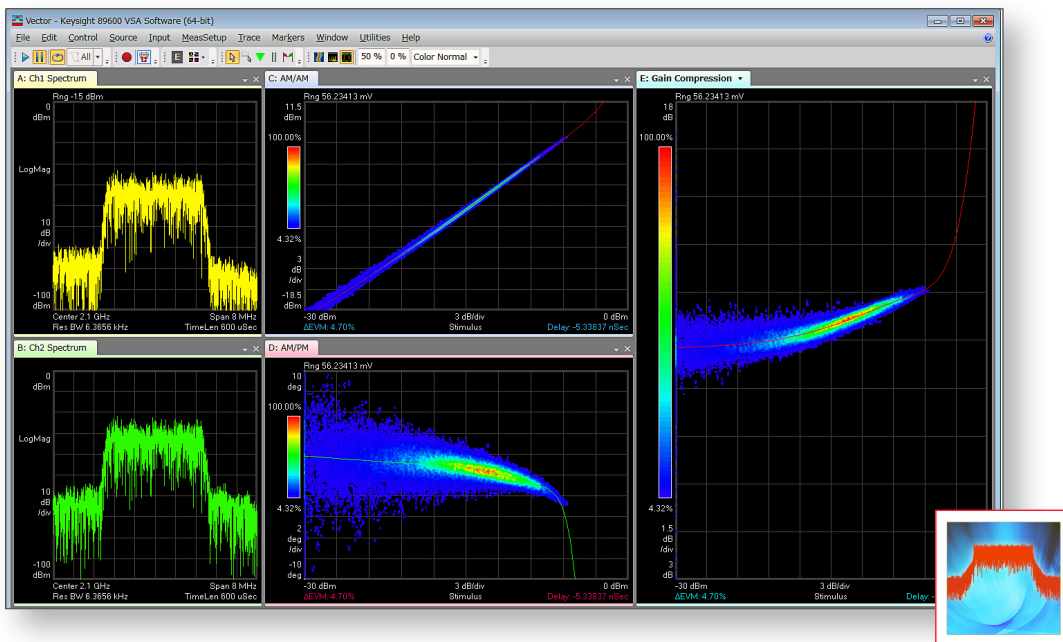

- Measure and analyze signals in the time, frequency and modulation domains
- Analyze data from over 40 supported hardware instruments, or use in simulation tools to verify design
- Characterize power amplifier behavior with complex stimulus-response measurements
- Configure, execute and display multiple measurements simultaneously or sequentially with unlimited number of traces and markers
- Record and playback signals for thorough analysis
- Automate tests using .NET language (full coverage) or SCPI (partial coverage)

Technical Overview

Basic vector signal analysis (Option 200) provides the foundation of the tools and user interface that make up the 89600 VSA software. Explore virtually every facet of today's most complex signals with views of time, frequency and modulation domains. Benefit from the flexible GUI capabilities: arbitrary arrangement and sizing of unlimited display traces, each with unlimited markers. Powerful display formats, signal recording and playback, and detailed Help text provide the insight needed for analyzing signals. Use the 89600 VSA software in simulation with sink and source components providing real-time, interactive analysis of results. Co-simulation is available with Keysight Technologies, Inc. EEsos Advanced Design System (ADS) and SystemVue ESL as part of Option 200.

Hardware connectivity (Option 300) allows the 89600 VSA software to be linked to over 40 Keysight instruments. Choose the right instrument for your application and apply vector signal analysis across your mixed signal design. Use the 89600 VSA software for consistent, comparable results at simulation, prototype and design-validation stages of development.

These options work together to provide a comprehensive set of tools for demodulation and vector signal analysis. These tools enable you to explore virtually every facet of a signal and optimize your most advanced designs. As you assess the tradeoffs, the 89600 VSA helps you see through the complexity.

Vector signal analysis

Today's wide-bandwidth, vector-modulated (also called complex or digitally modulated), time-varying signals benefit greatly from the capabilities of FFT analysis and other DSP techniques. Vector signal analysis offers fast, high-resolution spectrum measurements, demodulation, and advanced time-domain analysis. It is especially useful for characterizing burst, transient, or modulated signals used in communications, video, broadcast, radar, and ultrasound imaging applications.

The 89600 VSA software is fundamentally a digital system that uses data and mathematical algorithms to perform analysis. All it requires is sampled data from an instrument, software, or digital bus. As a larger portion of wireless designs becomes digital, the 89600 VSA software is uniquely suited to provide signal analysis for these complex systems.

The 89600 VSA software running on a PC uses a measurement "front-end" or data acquisition subsystem to provide formatted sampled data. The front-end performs the following functions: connection to the device under test, signal digitizing, signal capture capability, and data transfer to the PC in a sequential stream of data blocks. Once the data blocks are available, the 89600 VSA software is able to perform all vector and modulation analysis functions.

Try Before You Buy!

Download the 89600 VSA software and use it free for 30 days to make measurements with your analysis hardware, or use our recorded demo signals by selecting File > Recall > Recall Demo > Signals > on the software toolbar. Request your free trial license today:

www.keysight.com/find/89600_trial

Analysis and Troubleshooting

Find the root cause of signal problems with advanced troubleshooting tools

Quantify spectral performance with high-resolution FFT-based measurements and a rich set of markers. Analyze time domain signal quality using pulse-timing features, robust trigger controls, CCDF, and more. Use analog demodulation to characterize AM, FM and PM behavior.

Complex stimulus-response measurements enable plotting of one signal versus another for results like AM/AM, AM/PM and gain compression. Automatic time alignment, amplitude normalization and phase error compensation greatly simplify measurement setup. As the industry's only solution to correlate baseband and RF signals, the 89600 VSA software is ideal for characterizing envelope tracking power amplifier and power supply designs.

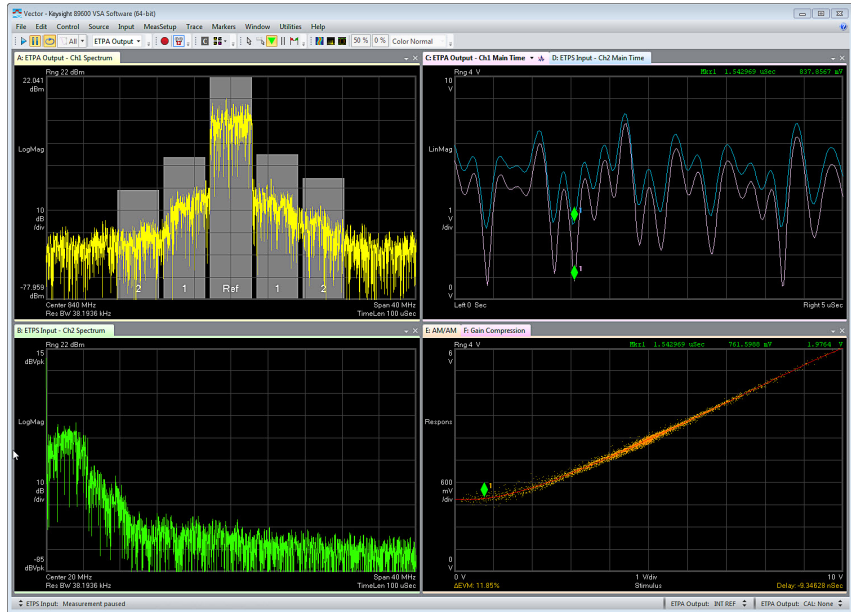

Complex stimulus-response measurements analyze envelope tracking power amplifier and power supply signals together, providing envelope/RF time alignment and shaping information.

Catch short-lived signal events using sophisticated displays and triggering

The digital persistence, cumulative history and spectrogram displays are useful for viewing signal amplitude and frequency behavior over time and identifying infrequently occurring events. Capture elusive signals with flexible magnitude and external triggers, as well as frequency mask trigger (FMT) with real-time enabled UXA, PXA and MXA signal analyzers. Initiate measurements or recordings based on trigger conditions to analyze and thoroughly characterize dynamic signals. Time qualified trigger may be combined with FMT and IF magnitude triggers.

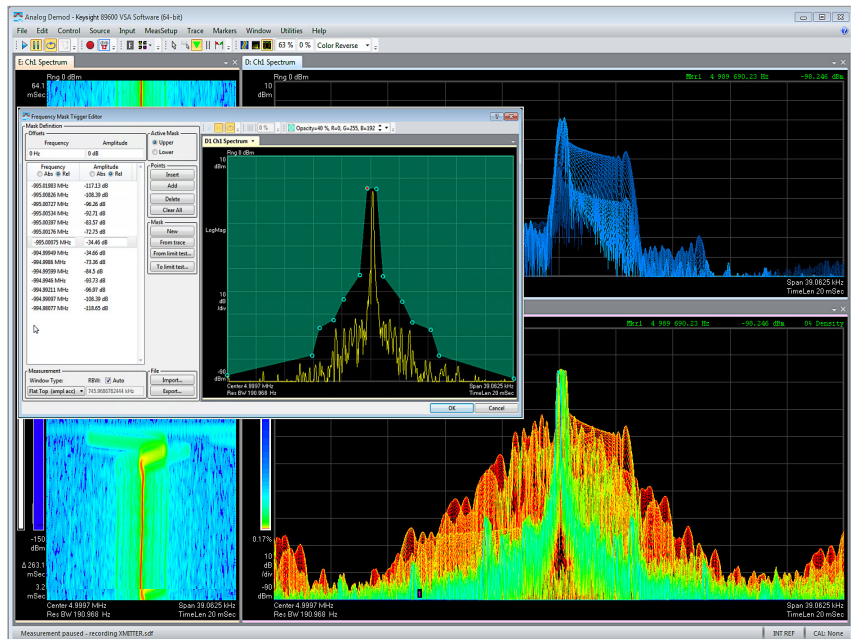

Powerful visualization and triggering tools highlight subtle and transient events like this radio turn-on event.

Display unlimited traces simultaneously to gain greater clarity

Pinpoint problems with arbitrary arrangement and sizing of trace windows. You can assign any measurement to any trace, as well as unlimited markers per trace. Optimize the trace window shape to see the most data in each trace. A docking manager tool lets you position traces anywhere within the 89600 VSA software display window. Multiple display windows can be created to manage a large number of results or take advantage of multiple monitors.

Record and analyze your signals in detail

Especially useful in early R&D, you can capture transient events, compare signal outputs after design iterations, or share the signal for collaborative analysis with remote colleagues. Additional tools, like overlap processing, let you effectively “slow down” the apparent measurement for more in-depth analysis.

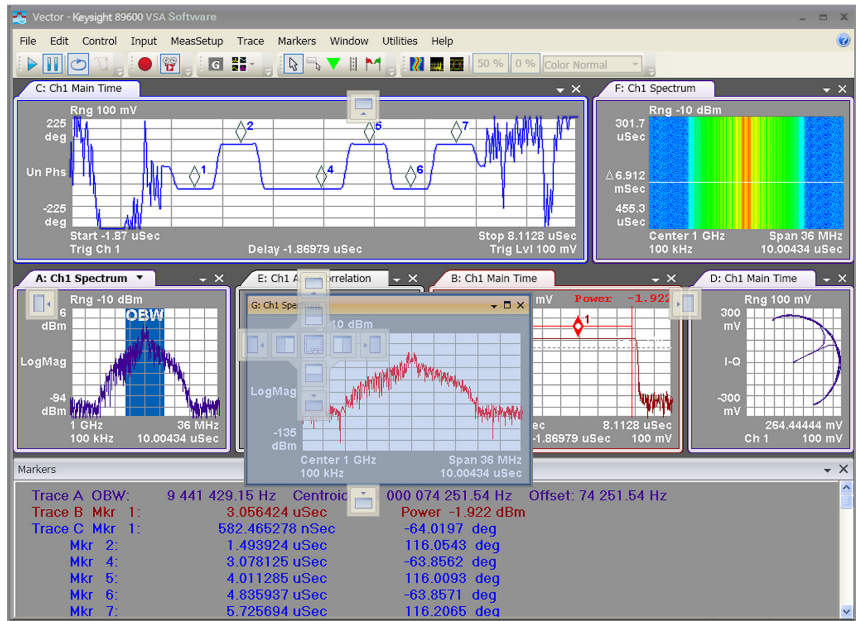

Show unlimited traces, each with unlimited markers, wherever and however you need them. Overlay related traces or hide them. Undock a window and place it anywhere on your desktop using the docking manager tool.

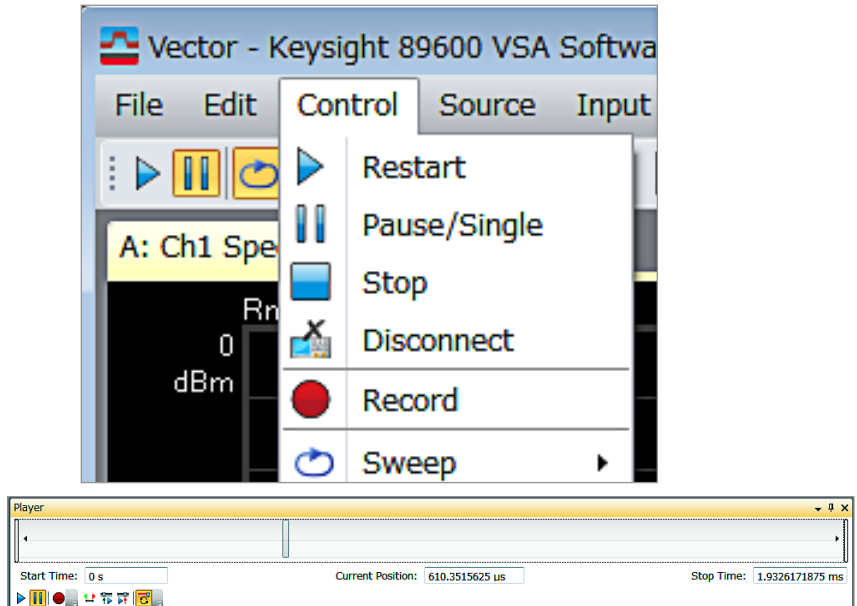

The 89600 VSA software lets you record signals. Using familiar recording controls, you can replay and analyze the signal as though it were a live measurement.

Make use of sophisticated tools with an easy-to-use GUI

The 89600 VSA software features many time-saving GUI features. Hover your mouse over a display “hot spot” to bring up a special cursor and a helpful message. To change a value, you can choose from a drop-down menu, scroll using the mouse, or type in a numeric value, depending on the parameter. Right-clicking in the trace display brings up a menu of often-used tools, such as Y-autoscale. The 89600 VSA software’s toolbar includes one-button selection of other common tasks, such as auto-range, record, start/stop, special markers selection, macros, and more.



GUI tools let you easily set up your measurements and customize your work area. Hover your mouse over the many “hot spots” on the display, shown highlighted here. Use them to easily change any parameter value without accessing the menus. In addition, you can right-click in the display to bring up a menu of frequently-performed tasks, like auto-scaling the trace.

Learn about the 89600 VSA—the fast way

Dynamic Help lets you access detailed information on the product and its applications. Place your mouse over any trace or menu and the pertinent Help text automatically appears - this is particularly useful when setting up complex new modulation schemes. Help text includes information on using the 89600 VSA software, setting up measurements, and application information for the specific modulation schemes.

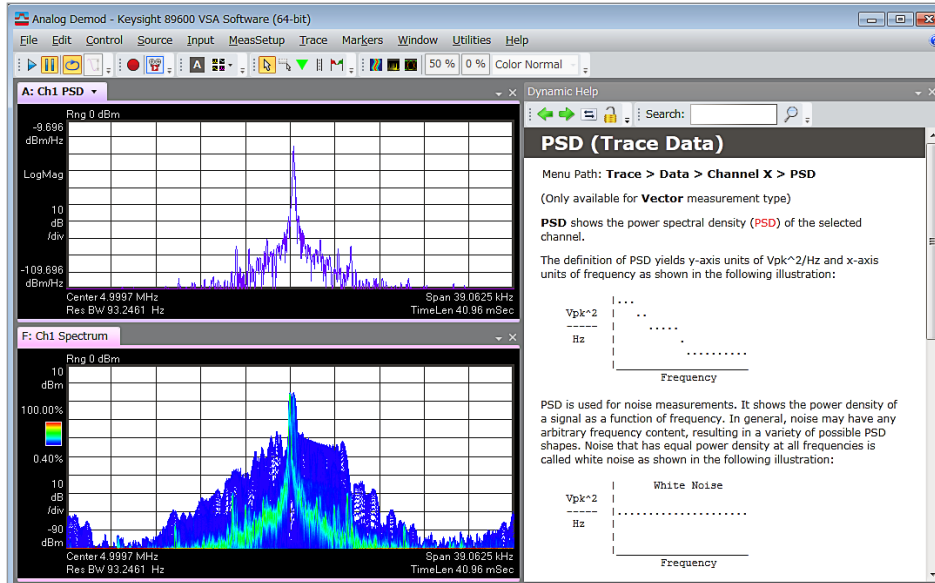

Click in a trace (to make it active) or hover your mouse over a menu and Dynamic Help will provide you with an instant display of user documentation. The content can be locked to show your desired information, and the Help window detached and placed anywhere on your workspace.

Develop automated tests easily

Create design verification tests using familiar SCPI or any supported .NET language. Use macro recording to capture key-strokes and automate repetitive tasks. The macros toolbar can be displayed for easy macro selection.

Connect to over 40 instrument platforms

Option 300 lets you choose from signal analyzers, oscilloscopes, logic analyzers, modular instruments, and more. The same GUI is used to control measurements, no matter what hardware platform is used, minimizing the learning curve. Connect to the instruments via GPIB, LAN, USB, PXI interface, or embedded PXI controller. Or, run it inside the instrument itself if it is PC-based. For a list of currently supported products, go to (www.keysight.com/find/89600_hardware). A configuration menu simplifies the instrument detection and validation process.

Make measurements anywhere in your design process

Use the 89600 VSA software in simulation environments to analyze and visualize simulated results. When device prototypes are ready, select the measurement hardware best suited to your task and apply the same 89600 VSA software measurement science to your physical device under test. Access analog and digital baseband; IF and RF signals, comparing signal quality parameters, like EVM, from one signal block to the next, from simulation to implementation.

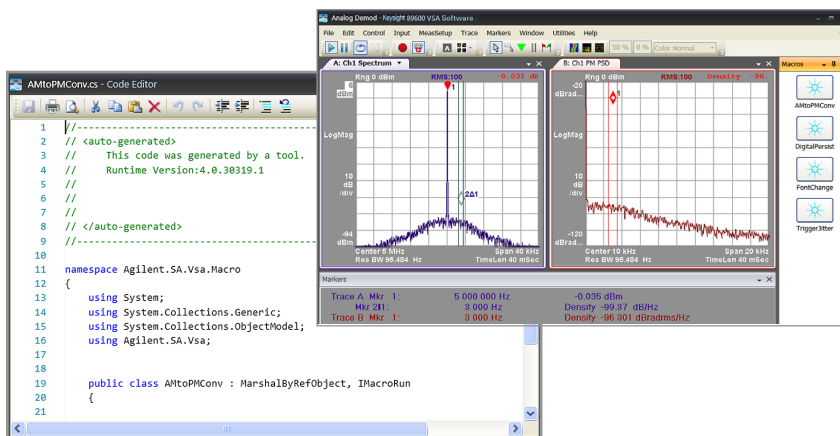

Automate tests using programs written in SCPI or any supported .NET language. The 89600 VSA software also supports macros developed with C# and other languages.

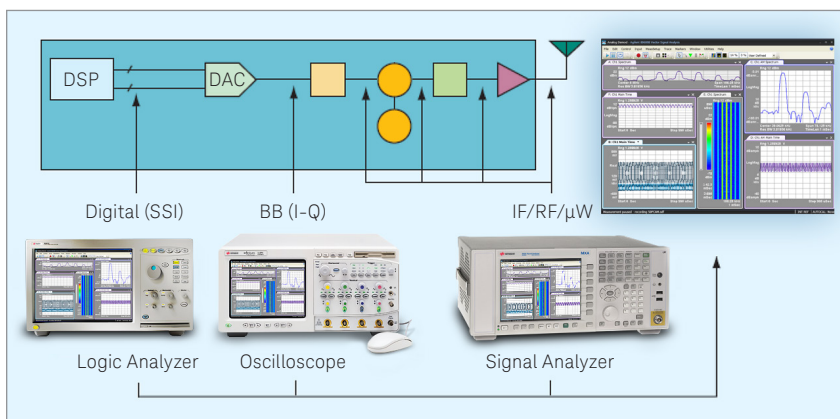

Whether you're making measurements using a logic analyzer, oscilloscope, or signal analyzer, the UI and measurement algorithms are the same. Safely compare results from baseband to RF and evaluate against your error budget.

Simultaneously create, configure, and execute multiple measurements

The new, innovative multi-measurement capability is now standard in the 89600 VSA software. The multi-measurement capability allows you to configure, execute and display several measurements at once, simplifying and speeding analysis of multi-carrier or multi-format devices, simultaneous uplink and downlink signals, or single signals compared at multiple test points (baseband, IF, RF). When all signals are spaced to fit within an instrument's analysis bandwidth, measurements are perfectly simultaneous. For wider frequency coverage, the VSA software can coordinate two or more independent instruments to acquire all desired signals. You can also configure the data acquisition mode from synchronous (default) or sequenced to speed up measurement switching time from one to another.

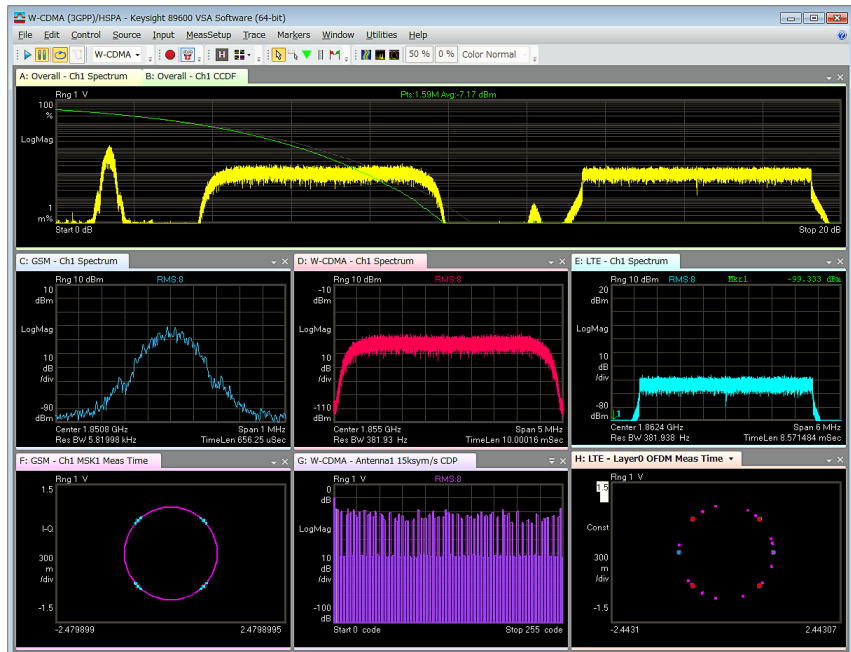

Multi-measurements in action: Traces A and B provide a composite spectrum overlaid with the CCDF statistics for the combined waveform. Traces C and F show a GSM signal. Traces D and G outline a W-CDMA downlink signal and Traces E and H analyze an LTE downlink signal.

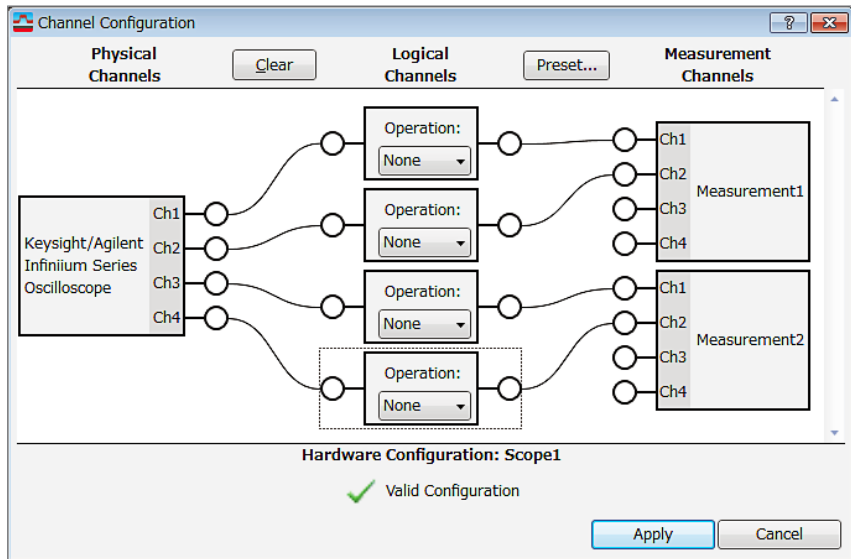

Channel configuration wizard lets you view and map hardware channels to multiple measurements.

Software Features

Basic VSA (Option 200)

Note: The following features are independent of hardware platform used, unless otherwise noted.

Time and waveform			
Time record characteristics		In the 89600 VSA software, measurements are based on time records. A time record is a block of samples of the signal waveform from which time, frequency, and modulation domain data is derived.	
Data mode	Two signal processing modes, baseband and zoom, affect the appearance and the duration of input waveforms displayed.		
Zoom	Measurements are made with non-zero start frequency. Time domain display shows a complex envelope representation of the input signal, i.e. the magnitude and phase of the signal relative to the analyzer's center frequency.		
Baseband	Measurements begin at 0 Hz. The input signal is directly digitized and the waveform display shows the entire signal (carrier plus modulation), much as an oscilloscope would.		
Time record length (main time)	$\frac{\text{(Number of frequency points - 1)}}{\text{Span with RBW mode set to arbitrary, auto-coupled}}$		
Time sample resolution	1/(k x span) Where: k = 2.56 for time data mode set to baseband k = 1.28 for all other modes (default) including zoom Span = Currently selected frequency span		
Time recording characteristics	In recording (time capture) mode the incoming waveform is captured gap-free into high-speed time capture memory. This data may then be replayed at full or reduced speed, saved to mass storage, or transferred to another software application. When time analyzing the captured waveform, users may adjust measurement span and center frequency in order to zoom in on a signal, as long as the new measurement span lies entirely within the originally captured span.		
Time recording memory size	Memory size is dependent on the hardware used. See hardware specifications for more information.		
Resolution bandwidth (RBW)			
RBW values	The range of available RBW choices is a function of the selected frequency span and the number of calculated frequency points. Users may step through the available range in a 1-3-10 sequence or directly enter an arbitrarily chosen bandwidth.		
Range	< 1 Hz to > 0.287 x Max Span		
RBW shape factor	The window choices below allow the user to optimize the RBW shape as needed for best amplitude accuracy, best dynamic range, or best response to transient signal characteristics.		
	Selectivity	Passband flatness	Rejection
Flat top	0.41	0.01 dB	> 95 dBc
Gaussian top	0.25	0.68 dB	> 125 dBc
Hanning	0.11	1.5 dB	> 31 dBc
Uniform	0.0014	4.0 dB	> 13 dBc
Blackman-Harris	0.26	0.83 dB	> 92 dBc
Kaiser-Bessel	0.26	0.83 dB	> 89 dBc
Gaussian	0.22	0.83 dB	> 73 dBc

Measurement display and control	
Input	
Channels	Up to 8 (hardware dependent)
Format	Individual; I+jQ (ch1 + jch2); dual I+jQ (ch1 + jch2, ch3 + jch4)
Range	Selectable, or one-shot auto-range which sets full scale input range of the hardware. Applies to current active or all channels
Coupling	AC, DC
Connection	Single-ended; differential (balanced)
Triggering	
Trigger types	All trigger types are not available for all hardware
Free run	Measurements run continuously without waiting for any trigger condition
Channel	Level-based trigger used with baseband signals only
IF magnitude	Trigger on in-band energy, where trigger bandwidth is determined by the measurement span. For zoom data. Time criteria is available when wideband digital IF is installed on UXA, PXA or MXA signal analyzers.
External	Trigger signal provided to hardware through external trigger port
Periodic	Available only for PSA Option 122 measurement hardware
Frequency mask trigger	Frequency selective trigger, initiates measurement based on frequency mask and trigger criteria. Only available with real-time enabled PXA or MXA signal analyzer. May be combined with time criteria.
Playback trigger	Trigger on recorded data during playback using free run, channel or magnitude triggers
Trigger delay	Allows pre-trigger (negative) and post-trigger (positive) delay. Delay value range is hardware dependent.
Trigger hold-off	Prevents re-triggering until a full hold-off period has elapsed
Trace data	
For up to 8 channels, each channel displayed individually	
Autocorrelation	Autocorrelation for the selected input channel, used to determine if the signal repeats within itself, as in multipath
CCDF	Complementary cumulative distribution function
CDF	Cumulative distribution function
Correction	Shows the correction data derived from calibration data
Gate time	Portion of the main time record marked by the gate, when time gating is on
Instantaneous main time	Unaveraged time data
Instantaneous spectrum	Unaveraged spectrum data
Main time	Corrected, resampled time data
PDF	Probability density function
PSD	Power spectral data
Raw main time	Raw time series data
Spectrum	Frequency spectrum computed from time trace data
Graph	
AM/AM	Response signal magnitude vs stimulus signal magnitude
AM/PM	Response signal phase vs stimulus signal magnitude
Gain compression	Gain vs stimulus signal magnitude
Stimulus time	Stimulus signal after compensation and time alignment
Response time	Response signal after compensation and time alignment
Delta EVM time	Magnitude of the differential error vector between the stimulus and response signals vs time

Trace data (continued)		For up to 8 channels, each channel displayed individually
Marker		Displays ACP or OBW tabular data
Math		Displays computed data in math register
Channel N x M (where M<N) cross channel data		
Coherence		Indicates similarity between two signals
Cross correlation		Determines time delays of a common signal between two different paths
Cross spectrum		Cross power spectrum of ch N vs ch M
Frequency response		Frequency response of ch N vs ch M
Impulse response		Inverse of frequency response for ch N vs ch M
Trace math		
Uses		Trace math can be used to manipulate data on each measurement. With multi-measurements, trace math can be done between results from different measurements. Applications include user-defined measurement units, data correction, and normalization.
Operands		Measurement data, data register, constants, $j\omega$
Operations		+, -, x, /, conjugate, magnitude, phase, real, imaginary, square, square root, FFT, inverse FFT, windowing, logarithm, exponential, peak value, reciprocal, phase unwrap, zero
Graphs		Perform complex stimulus-response measurements with modulated signals
Graph settings		Stimulus and response data selection (auto or manual) Compensation (amplitude normalization, time alignment, phase error compensation) Polynomial order of curve-fit line
Graph results		Differential error vector magnitude, averaged over all time points Average gain of response data over stimulus data Delay between stimulus and response data Average stimulus power Average response power Coefficients for curve-fit line
Trace appearance		
Trace formats		Log mag (dB or linear), linear mag, real (I), real (Q), wrap phase, unwrap phase, I-Q, constellation, I-eye, Q-eye, trellis-eye, group delay
Trace layouts		Unlimited traces, displayed on detachable grids with user-determined layout
Number of colors		User-definable color palette
Special visualization displays		Unique visual tools providing ways of looking at time-varying signals
Adjustable parameters		
Color mapping		Color normal, color reverse, grey normal, grey reverse, user-defined
Enhance		Determines how colors are distributed.
Threshold		Sets threshold value for currently selected visualization display type
Display types		Cumulative history, digital persistence, spectrogram
Averaging		
Types		RMS (video), RMS (video) exponential, peak hold, time, time exponential
Number of averages, maximum		> 10 ⁸
Overlap processing		0 to 99.99%

Time gating	
Features	Time-selective frequency domain analysis on any input or analog demodulated time-domain data. Independent gate delays can be set for each input channel.
Gate length, maximum	Main time length
Gate length, minimum	Window shape/(0.3 x frequency span) where window shape is:
	<ul style="list-style-type: none"> Flat top 2.2 Hanning 1.5 Uniform 1 Blackman-Harris 2.0044 Kaiser-Bessel 2.0013 Gaussian 2.0212 Gaussian Top 2.215
Markers	
Number available	Unlimited markers per trace
Types	Normal, delta, fixed, OBW, ACP, spectrogram
Search	Peak, next peak left, next peak right, peak lower, peak higher, minimum
Copy marker to>	Start freq, stop freq, center freq, ref level, despread chan, analysis TS/FS, delta to span, counter to center frequency, centroid to center
Marker functions	Peak signal track, frequency counter, band power, couple
Band power	Can be placed on any time, frequency, or demodulated trace for direct computation of band power, rms square root (of power), C/N, or C/No, computed within the selected portion of the data.
Occupied bandwidth (OBW)	Placed on spectrum traces only to dynamically compute the bandwidth required to provide x% of power in the band. User selectable from 0 to 100%
OBW results	<ul style="list-style-type: none"> Total power in span Power in OBW Power ratio (OBW/Span) OBW lower frequency OBW higher frequency OBW Centroid frequency Offset frequency (measurement center freq – centroid freq)
Adjacent channel power	Placed on spectrum traces only
User-settable parameters	<ul style="list-style-type: none"> Center frequency and bandwidth of the carrier channel Offset frequency and bandwidth of each offset channel Reference offset allows offset channel to be centered anywhere on screen
ACP results	<ul style="list-style-type: none"> Pass/fail limits for each offset (applied to both lower and upper result) Carrier band power Power in both lower and upper offset bands for each frequency offset Power in both lower and upper offset bands for each frequency offset, relative to the carrier (ACPR) Worst case (of the upper and lower offsets) ACPR for each frequency offset Pass/fail condition relative to user supplied thresholds

Limit lines	
Limit tests	Collection of limit lines applied to trace data. Defined by user or from save trace.
Marker results	Pass/fail status for limit and margin; worst-case failed point, or smallest-margin point if no failure; limit test status for all traces, limit line table with tabular results
Settable line parameters	Upper, lower limit; limit margin Export/import from frequency mask
Limit programming	All features controllable via .NET
Limit test failure	Generates measurement status event
Software interface	
Programming and macros	Fully encapsulates all access to the front-end measurement hardware. Direct programmatic access to the measurement hardware is not required and not supported by any of these interfaces.
Remote programming	
.NET	.NET is the primary remote interface. Software development environments capable of interacting with .NET remoting include Microsoft Visual Studio and others.
SCPI	The SCPI remote interface allows SCPI-based instrument controllers full access to a subset of 89600 VSA software features. Compatible SCPI software development environments include Keysight VEE and Keysight Command Expert. MATLAB users should consider using SCPI for their remote programming needs.
COM	COM API compatibility interface allows applications written for the previous generation 89601A to access many of the features of the 89600 VSA software while minimizing required code changes. Compatible software development environments include Microsoft Visual Studio and others.
Macro language	Supports macro-recording with a built-in editor using C# and VB.NET. Also, macros can be developed using any supported .NET language. Full-featured code editor complete with syntax coloring allows copy and paste into Microsoft Visual Studio for editing and debugging. Macros developed for the 89601A using VBA can only access features that are part of the COM compatibility interface.
Remote displays	To operate the 89600 VSA software or view its display from a remote location, the use of commercially available remote PC software is recommended.
File formats	
ASCII	Tab delimited (.txt), comma delimited (.csv)
Binary	Keysight standard data format (.sdf, .cap, .dat), Keysight E3238 search system time snapshot (.cap), time recording (.cap) files under 2 GB in size. Keysight N5110 or N5106 signal generator files (.bin) under 2 GB in size.
MATLAB 4 and later	MAT-file (.mat)
MATLAB 2006 and later	MAT-file (.mat) and HDF5 file format (.hdf, .h5)
Simulation environments	
Supported software	Keysight SystemVue ESL, Keysight Advanced Design System (ADS), MathWorks Simulink (only available with VSA version 7.00 to 17.20)

Key Specifications

This technical overview provides nominal performance specifications for the software when making measurements with the specified platform.¹ Nominal values indicate expected performance, or describe product performance that is useful in the application of the product, but is not covered by the product warranty. For a complete list of specifications refer to the measurement platform literature.

Basic VSA (Option 200)

X-Series signal analyzers

General performance	UXA	PXA	MXA	EXA	CXA				
The specifications in this table represent a summary of the performance of the instruments indicated and apply for cases where the 89600 VSA software is installed inside the instrument as well as when it is used with an external PC controller connected via LAN.									
See the I/Q Analyzer section of the respective X-Series signal analyzer data sheets for more information									
Literature number	5992-0090EN	5990-3952EN	5989-4942EN	5989-6529EN	5990-4327EN				
Frequency									
Minimum frequency									
AC coupled	10 MHz	10 MHz	10 MHz	10 MHz	9 kHz (Option 503/507) 10 MHz (Option 513/526)				
DC coupled	3 Hz	3 Hz	10 Hz	10 Hz	9 kHz (Option 513/526)				
Maximum frequency									
Option dependent	up to 26.5 GHz	up to 50 GHz	up to 26.5 GHz	up to 44 GHz	up to 26.5 GHz				
Center frequency tuning									
Resolution	10 μ Hz	10 μ Hz	1 mHz						
Frequency span									
Option dependent	up to 510 MHz	up to 160 MHz	up to 160 MHz	up to 40 MHz	up to 25 MHz				
Frequency span Baseband IQ (Option BBA)									
		I+jQ BW	1 ch BW	2 ch BW	I+jQ BW	1 ch BW	2 ch BW		
Standard		20 MHz	10 MHz	10 MHz	20 MHz	10 MHz	10 MHz		
Option B25		50 MHz	25 MHz	20 MHz ²	50 MHz	25 MHz	20 MHz ²		
Option B40		80 MHz	40 MHz	20 MHz ²	80 MHz	40 MHz	20 MHz ²		
Frequency points per span									
Calibrated points	51 to 409,601								
Displayed points	51 to 524,288								

1. Data subject to change
2. Values are for baseband measurements; values increase to match 1 ch BW for zoom measurements. Select baseband/zoom in the 89600 VSA software by clicking on MeasSetup>Frequency (tab)>Time Data> then either baseband or zoom.

General performance	UXA	PXA	MXA	EXA	CXA
Input	Full scale, combines attenuator setting and ADC gain				
Range					
Without preamp	-22 dBm to +30 dBm (2 dB steps)		-20 dBm to 30 dBm (2 dB steps)	-20 dBm to 20 dBm (10 dB steps)	
With Option FSA or EA3				-20 dBm to 22 dBm (2 dB steps)	
With preamp, f < 3.6 GHz	-42 dBm to +30 dBm (2 dB steps)		-40 dBm to 30 dBm (2 dB steps)	-40 to 20 dBm (10 dB steps)	
With Option FSA or EA3				-40 to 22 dBm (2 dB steps)	
With preamp, f > 3.6 GHz	-56 dBm to +30 dBm (2 dB steps)			-50 to 20 dBm (10 dB steps)	
With Option FSA or EA3				-54 to 22 dBm (2 dB steps)	
Option BBA (50 ohm input)	-8 dBm to 10 dBm				
Option BBA (1 Mohm input)	-14 dBm to 4 dBm				
ADC overload	+2 dBfs				

General performance		PXA	MXA	EXA	CXA				
Amplitude accuracy									
Absolute amplitude accuracy									
RF input	< 3.6 GHz				< 3.0 GHz (standard)				
	±0.19 dB (span ≤ 10 MHz) ±0.69 dB (span 25 MHz to 160 MHz)	± 0.23 dB	± 0.27 dB	± 0.60 dB					
BBIQ inputs ¹	± 0.07 dB ²								
Amplitude linearity³									
RF input	± 0.1 dB	± 0.10 dB (-70 dBfs to 0 dBfs) ± 0.15 dB (< -70 dBfs)	± 0.15 dB (-70 dBfs to 0 dBfs) ± 0.25 dB (< -70 dBfs)	± 0.30 dB (-5 dBfs to 0 dBfs) ± 0.15 dB (-70 dBfs to -5 dBfs)					
BBIQ inputs ¹	± 0.10 dB (0 to -45 dBfs) ⁴ ± 0.20 dB (< -45 dBfs) ⁴								
Sensitivity									
	-152 dBm/Hz	(≤ 25 MHz span, frequency 10 MHz to 1.8 GHz, input range -22 dBm)	-151 dBm/Hz	(10 MHz to 2.1 GHz, -20 dBm range)	-147 dBm/Hz	(10 MHz to 2.1 GHz, -20 dBm range)	-144 dBm/Hz	(10 MHz to 2.2 GHz, -20 dBm range)	
	-144 dBm/Hz	(25 MHz to 40 MHz span, frequency 10 MHz to 1.8 GHz, input range -22 dBm)	-163 dBm/Hz	(10 MHz to 2.1 GHz, -40 dBm range, requires Option P0x)	-160 dBm/Hz	(10 MHz to 2.1 GHz, -40 dBm range, requires Option P03)	-160 dBm/Hz	(10 MHz to 2.2 GHz, -40 dBm range, Option P0x and Option 503 or 507)	
	-151 dBm/Hz	(40 MHz to 160 MHz span, frequency 10 MHz to 1.8 GHz, input range -22 dBm)					-158 dBm/Hz	(10 MHz to 3 GHz, -40 dBm range, Option P0x and Option 513 or 526)	
Dynamic range									
Third-order inter-modulation distortion	Two tones, frequency range 10 MHz to 13.6 GHz			Two tones, frequency range 400 MHz to 13.6 GHz		Two tones, frequency range 500 MHz to 7.5 GHz			
Span	≤ 25 MHz	25 MHz to 40 MHz	40 MHz to 160 MHz	≤ 40 MHz		≤ 25 MHz (Option 503 or 507)	≤ 25 MHz (Option 513 or 526)		
Tone separation	> 100 kHz	> 1 MHz		> 15 kHz		> 100 kHz			
Tone level	-20 dBfs	-9 dBfs		-20 dBfs		-10 dBfs			
TOI distortion	-90 dBc	-82 dBc	-80 dBc	-90 dBc	-82 dBc	-66 dBc	-64 dBc		
Noise density									
Input range	See PXA noise density graph			At 1 GHz					
≥ -10 dBm				-140 dBfs/Hz		-137 dBfs/Hz		-134 dBfs/Hz	
-20 dBm to -12 dBm				-131 dBfs/Hz		-127 dBfs/Hz		-124 dBfs/Hz	
-30 dBm to -22 dBm				-133 dBfs/Hz (requires preamp option)		-130 dBfs/Hz (requires preamp option)			
-40 dBm to -32 dBm				-123 dBfs/Hz (requires preamp option)		-120 dBfs/Hz (requires preamp option)			

- For complete Option BBA BBIQ specifications, see literature part number 5989-6538EN.
- Measured at -6 dB below max for each range, 250 kHz reference frequency, all ranges, nominal value.
- Reference level is input signal of -25 dBm at a range setting of 0 dBm.
- With dither turned on.

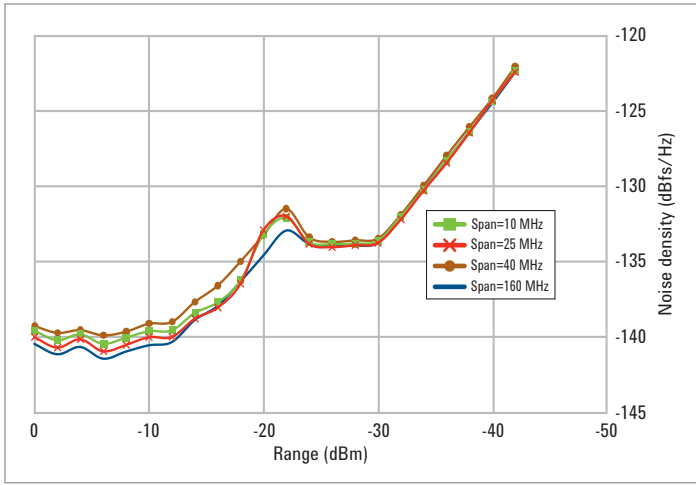

PXA noise density (nominal, 1.8GHz)

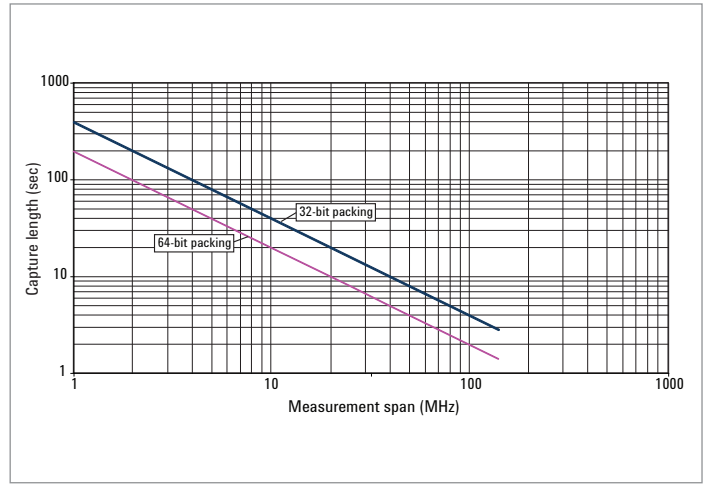

Capture length vs. span for MXA/EXA (with DP2, MPB, B40 or wider bandwidth) and PXA

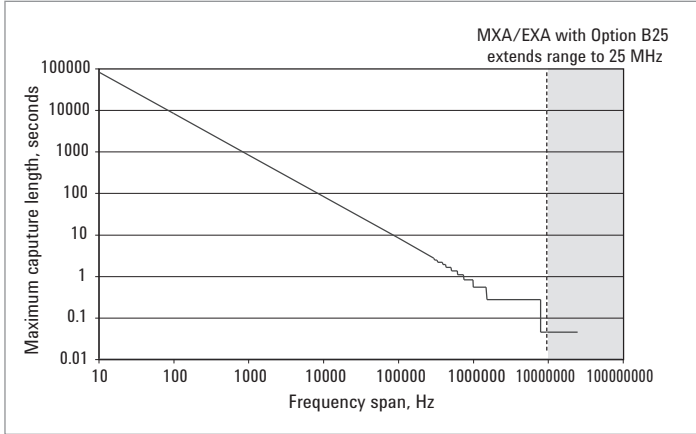

Capture length vs. span for MXA/EXA (without DP2, MPB, B40 or wider bandwidth)

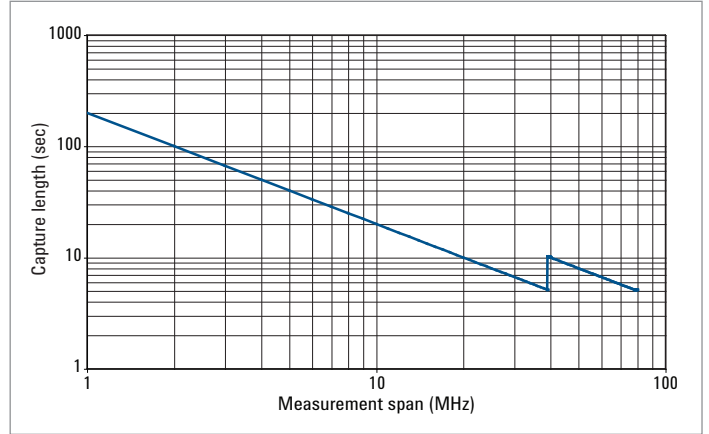

PXA and MXA (BBIQ mode) capture length vs. span

Time and waveform capture	PXA	MXA	EXA	CXA
Max capture size				
Complex samples	32 bits: 512 MSa 64 bits: 256 MSa 500 MSa (w/Option BBA)	4 MSa (Standard) 32 bits: 512 MSa ¹ 64 bits: 256 MSa ¹ 500 MSa (w/Option BBA)	4 MSa (Standard) 32 bits: 512 MSa ² 64 bits: 256 MSa ²	4 MSa
Max capture time (at max span)	(Complex samples, 32 bit)			
10 MHz (standard)	40 sec	266.6 msec	266.6 msec	266.6 msec
25 MHz (Option B25)	16 sec	88.8 msec	88.8 msec	88.8 msec
40 MHz (Option B40)	10 sec	10 sec	10 sec	
85 MHz (Option B85)	4.9 sec	4.9 sec		
125 MHz (Option B1A)		3.3 sec		
160 MHz (Option B1X)	2.6 sec	2.6 sec		
Analog modulation analysis	PXA	MXA	EXA	CXA
AM demodulation				
Conditions	Carrier ≤ -17 dBfs	Span ≤ 12 MHz; carrier ≤ -17 dBfs	Span ≤ 12 MHz; carrier ≤ -17 dBfs	Carrier ≤ -17 dBfs
Demodulator bandwidth	Same as selected measurement span			
Modulation index accuracy	$\pm 1\%$	$\pm 1\%$	$\pm 1\%$	$\pm 1\%$
Harmonic distortion	-50 dBc relative to 100% modulation index	-60 dBc relative to 100% modulation index	-55 dBc relative to 100% modulation index	-50 dBc relative to 100% modulation index
Spurious		-60 dBc relative to 100% modulation index		
Cross demodulation	< 1.1% AM on an FM signal with 50 kHz modulation rate, 200 kHz deviation	< 0.3% AM on an FM signal with 50 kHz modulation rate, 200 kHz deviation	< 0.5% AM on an FM signal with 50 kHz modulation rate, 200 kHz deviation	< 1.1% AM on an FM signal with 50 kHz modulation rate, 200 kHz deviation
PM demodulation				
Conditions	Deviation < 180°, modulation rate ≤ 500 kHz			
Demodulator bandwidth	Same as selected measurement span, except as noted			
Modulation index accuracy	$\pm 0.5^\circ$	$\pm 0.5^\circ$	$\pm 0.5^\circ$	$\pm 0.5^\circ$
Harmonic distortion	-55 dBc	-60 dBc	-55 dBc	-55 dBc
Spurious	-60 dBc	-60 dBc, span ≤ 12 MHz	-60 dBc	-60 dBc
Cross demodulation	(80% modulation index AM signal, modulation rate)			
	≤ 1 MHz		≤ 1 MHz	≤ 1 MHz
	CF < 3 GHz 1° PM	1° PM	Span < 10 MHz 1° PM	CF < 3 GHz 1° PM
	CF > 3 GHz 1.3° PM		Span > 10 MHz 1.5° PM (Option B25)	CF > 3 GHz 1.3° PM

1. With Option MPB, DP2, B40, B85, B1A or B1X.

2. With Option MPB, DP2 or B40.

Analog modulation analysis (continued)	PXA	MXA	EXA	CXA
FM demodulation				
Demodulator bandwidth	Same as selected measurement span			
Modulation index accuracy	±0.1% of span, deviation < 2 MHz, modulation rate ≤ 500 kHz			
Harmonic distortion				
Modulation rate ≤ 50kHz, deviation ≤ 200 kHz	-50 dBc	-60 dBc	-50 dBc	-50 dBc
Modulation rate ≤ 500 kHz, deviation ≤ 2 MHz	-45 dBc	-55 dBc	-45 dBc	-45 dBc
Spurious distortion				
Modulation rate ≤ 50kHz, deviation ≤ 200 kHz	-50 dBc	-50 dBc, span ≤ 12 MHz	-50 dBc	-50 dBc
Modulation rate ≤ 500 kHz, deviation ≤ 2 MHz	-45 dBc	-45 dBc	-45 dBc	-45 dBc
Cross demodulation	< 0.5% of span of FM on an 80% modulation index AM signal, modulation rate ≤ 1 MHz			

Hardware connectivity (Option 300)

For a complete list of specifications refer to the measurement platform literature.

Supported hardware

For a complete list of currently supported hardware, go to www.keysight.com/find/89600_hardware

Description	Models supported	Input channels	Baseband (I/Q)	MIMO	Analysis Bandwidth ¹	Frequency Range ¹	EVM Performance ^{1,2}	Applications
X-Series signal analyzers	N9000A, N9010A, N9020A, N9030A N9040B	1, 2 if N9010 or N9020 slaved together ⁴	Yes, optional	2x2 MIMO with dual N9010 or N9020A analyzers, time synchronous only ⁴	Up to 160 MHz; 25 MHz max for slaved units Up to 510 MHz	Up to 50 GHz	0.50% rms - 1.5% rms ³ TBD	Low cost to high performance baseband, RF, 2-ch MIMO
MXE EMI receiver	N9038A	1 RF	No	No	10 MHz Standard, 25 MHz with Option B25	8.4 GHz (Option 508), 26.5 GHz (Option 526) 44 GHz (Option 544)	Not Available	CISPR compliance testing, multiple measurement applications (like phase noise)
PSA spectrum analyzer	E4440A, E4443A, E4445A, E4446A, E4447A, E4448A	1, 2 if 2 units slaved together	No	2x2	Up to 80 MHz; 8 MHz max for slaved units	Up to 50 GHz	0.50% rms - 1.5% rms ⁵	High performance RF
ESA spectrum analyzer	ESA-E Series	1	No	No	10 MHz	Up to 26.5 GHz	0.40% rms - 1.8% rms ⁶	Economy RF analysis
Infiniium oscilloscopes	8064, 8104, 9064, 9104 ⁷ , 9254, 9404, 80204, 80304, 80404, 80604, 80804, 81004, 81204, 81304, 90254, 90404, 90604, 90804, 91204, 91304, X91304, X91604, X92004, X92504, X92804, X93204, X92004Q, X92504Q, X93304, X95004Q, X96204Q, 9024H, 9054H, 9104H, 9204H, S054A, S104A, S204A, S254A, S404A, S604A, S804A Z204A, Z254A, Z334A, Z504A, Z634A	1, 2, 3, 4	Yes, including dual I+JQ	Up to 4x4, including baseband	61 GHz (62.5 GHz with reduced alias protection)	61 GHz (62.5 GHz with reduced alias protection)	Not available	Wide bandwidth; baseband; economic MIMO analysis

1. Depending on model/option.

2. On QPSK signal; full scale signal, fully contained in the measurement span; random data sequence; start frequency $\geq 15\%$ of span; alpha/BT ≥ 0.3 ; symbol rate ≥ 1 kHz; averaging = 10; Requires Option AYA. Data provided for comparison purposes only.

3. Frequency < 3.6 GHz; range ≥ -30 dBm.

4. Option B40 is not supported (i.e. if any analyzer has Option B40, it cannot be used together with another analyzer).

5. Frequency < 3 GHz; range ≥ -24 dBm.

6. Frequency between 30 MHz and 3 GHz; range ≥ -20 dBm.

7. Full sample rate = 10 Gsa/s.

Description	Models supported	Input channels	Baseband (I/Q)	MIMO	Analysis Bandwidth ¹	Frequency Range ¹	EVM Performance ^{1,2}	Applications
InfiniiVision oscilloscopes	601x, 603x, 703x, 605x, 705x, 610x, 701x, 710x, 6014, 6054, 6104, 305x, 303x, 3024, 3014, 3012, 310x, 4154, 4104, 405x, 403x, 402x	1, 2, 3, 4 depending on model and options	Yes, for all 2-channel scopes; dual I+jQ with 4-channel models	Up to 4x4	Up to 1 GHz	Up to 1.5 GHz	Not available	Wide bandwidth; baseband; economic baseband MIMO analysis
Logic analyzer	16800/16900; RDX	1-4 channel analysis	No	No	Up to 1.5 GHz	Up to 1.5 GHz	Not applicable	Digital bus and FPGA analysis, all apps
N7109A Multi-channel signal analyzer	N7109A	2, 4 or 8 (configuration dependent)	No	Up to 8x8	40 MHz	6 GHz (Independently tunable)	-42 to -45 dB	Modular, cost effective, fast, high-perf MIMO, LTE Beamforming, LTE Adv multi-band carrier aggregation
PXI vector signal analyzers	M9393A	Up to 4 per chassis	No	Up to 4x4	Up to 160 MHz	9 kHz to 27 GHz	Not available	Modular, high performance, fast, MIMO
	M9392A	Up to 4 per chassis	No	Up to 4x4	Up to 250 MHz (up to 800 MHz) ³	50 MHz to 26.5 GHz	Not available	Modular, wide bandwidth, fast, MIMO
	M9391A	Up to 4 per chassis	No	Up to 4x4	Up to 160 MHz	1 MHz to 6 GHz	-42 dB to -47.5 dB (nominal) ⁴	Modular, wide bandwidth, fast, MIMO
AXIe high speed digitizer	M9703A	8	Yes	Up to 8x8	1 GHz	DC to 1.6 GHz	-44 dB and -47 dB (nominal) ⁴	Multi-channel, wide bandwidth, baseband, multi-antenna, MIMO
PCIe high speed digitizer	U5303A	8	Yes	Up to 8x8	1 GHz	DC to 1.6 GHz	Not available	Multi-channel, wide bandwidth, baseband, multi-antenna, MIMO
RF sensor	N6841A	1	No	No	Up to 20 MHz	20 MHz to 6 GHz	Not available	Outdoor weatherproof, cost effective

1. Depending on model/option.

2. On QPSK signal; full scale signal, fully contained in the measurement span; random data sequence; start frequency $\geq 15\%$ of span; $\alpha/BT \geq 0.3$; symbol rate ≥ 1 kHz; averaging = 10; Requires Option AYA. Data provided for comparison purposes only.

3. Digitizer only mode

4. Measurement made with a 256QAM signal and a 160 MHz analysis bandwidth (802.11ac).

X-Series signal analyzers

	UXA	PXA	MXA	EXA	CXA
Software and hardware feature availability and requirements					
Signal analyzer requirements					
Analysis bandwidth:					
Up to 10 MHz	Standard, no option required				
Up to 25 MHz	Option B25				
Up to 40 MHz	Option B40				
Up to 85 MHz	Option B85				
Up to 125 MHz	Option B1A				
Up to 160 MHz	Option B1X				
Up to 255 MHz	Option B2X				
Up to 510 MHz	Option B5X				
Baseband inputs	Option BBA				
External mixing	Option EXM				
Improved performance	Preamplifier options available				
PC to analyzer interface	The 89600 VSA software can run both inside an X-Series analyzer platform or on an external PC connected to the analyzer via LAN. Installing the 89600 VSA software into the analyzer enables its use with a connected mouse and keyboard via USB2.0. When the software is run in a remote PC, use of a LAN crossover cable, LAN hub, or LAN switch is required and allows the transfer of data from the signal analyzer.				
PC requirements	Visit www.keysight.com/find/89600-pc				

Note: When running the 89600 VSA software inside most of the X-Series instruments, you can gain immediate, direct access to all of the signal analyzer's features by pressing [Mode] on the analyzer, using Control > Disconnect on the 89600 VSA software's command toolbar, or closing the 89600 VSA software. When running the 89600 VSA software on a remote PC connected to the analyzer, you can use the same disconnect command or close the application.

You can upgrade!



All 89600 VSA Software options can be added after your initial purchase and are license-key enabled. For more information please refer to

www.keysight.com/find/89600_upgrades

Keep your 89600 VSA software up-to-date

With rapidly evolving standards and continuous advancements in signal analysis, the 89601BU/BNU software update and subscription service offers you the advantage of immediate access to the latest features and enhancements available for the 89600 VSA software.

www.keysight.com/find/89601BU

Additional Information

Literature

- 89600 VSA Software, Brochure, literature number 5990-6553EN
- 89600 VSA Software, Configuration Guide, literature number 5990-6386EN
- Keysight Vector Signal Analysis Basics, Application Note, literature number 5990-7451EN
- Exploring Signal Interactions with Multi-Measurements in the 86900 VSA Software, Application Note, literature number 5991-1620EN

Web

www.keysight.com/find/89600

www.keysight.com/find/systemvue

www.keysight.com/find/ads

www.keysight.com/find/sdr

For more information on Keysight Technologies' products, applications or services, please contact your local Keysight office. The complete list is available at: www.keysight.com/find/contactus

Americas

Canada	(877) 894 4414
Brazil	55 11 3351 7010
Mexico	001 800 254 2440
United States	(800) 829 4444

Asia Pacific

Australia	1 800 629 485
China	800 810 0189
Hong Kong	800 938 693
India	1 800 112 929
Japan	0120 (421) 345
Korea	080 769 0800
Malaysia	1 800 888 848
Singapore	1 800 375 8100
Taiwan	0800 047 866
Other AP Countries	(65) 6375 8100

Europe & Middle East

Austria	0800 001122
Belgium	0800 58580
Finland	0800 523252
France	0805 980333
Germany	0800 6270999
Ireland	1800 832700
Israel	1 809 343051
Italy	800 599100
Luxembourg	+32 800 58580
Netherlands	0800 0233200
Russia	8800 5009286
Spain	0800 000154
Sweden	0200 882255
Switzerland	0800 805353
	Opt. 1 (DE)
	Opt. 2 (FR)
	Opt. 3 (IT)
United Kingdom	0800 0260637

For other unlisted countries:
www.keysight.com/find/contactus
 (BP-07-10-14)

myKeysight

myKeysight

www.keysight.com/find/mykeysight

A personalized view into the information most relevant to you.

Three-Year Warranty

www.keysight.com/find/ThreeYearWarranty

Keysight's commitment to superior product quality and lower total cost of ownership. The only test and measurement company with three-year warranty standard on all instruments, worldwide.

Keysight Assurance Plans

www.keysight.com/find/AssurancePlans

Up to five years of protection and no budgetary surprises to ensure your instruments are operating to specification so you can rely on accurate measurements.

www.keysight.com/quality

Keysight Electronic Measurement Group

DEKRA Certified ISO 9001:2008

Quality Management System

Keysight Channel Partners

www.keysight.com/find/channelpartners

Get the best of both worlds: Keysight's measurement expertise and product breadth, combined with channel partner convenience.

