

isc Silicon NPN Power Transistor

2SC3989

DESCRIPTION

- High Collector-Emitter Breakdown Voltage-
: $V_{(BR)CEO} = 500V(\text{Min})$
- High Switching Speed
- Wide Area of Safe Operation

APPLICATIONS

- Designed for switching regulator and general purpose applications.

ABSOLUTE MAXIMUM RATINGS($T_a=25^\circ\text{C}$)

SYMBOL	PARAMETER	VALUE	UNIT
V_{CBO}	Collector-Base Voltage	800	V
V_{CEO}	Collector-Emitter Voltage	500	V
V_{EBO}	Emitter-Base voltage	7	V
I_C	Collector Current-Continuous	25	A
I_{CM}	Collector Current-Peak	40	A
I_B	Base Current-Continuous	8	A
P_C	Collector Power Dissipation @ $T_C=25^\circ\text{C}$	200	W
T_J	Junction Temperature	150	$^\circ\text{C}$
T_{stg}	Storage Temperature Range	-55~150	$^\circ\text{C}$

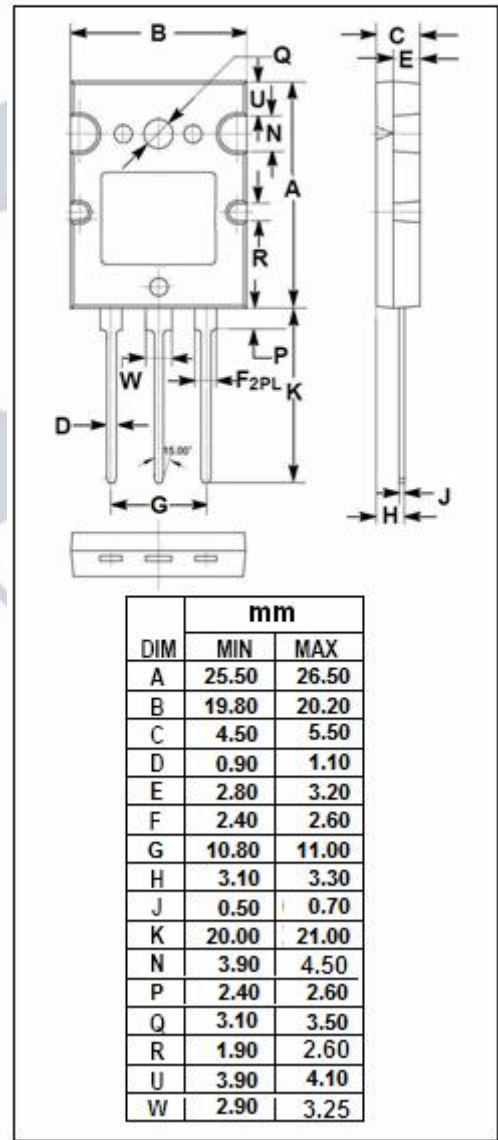
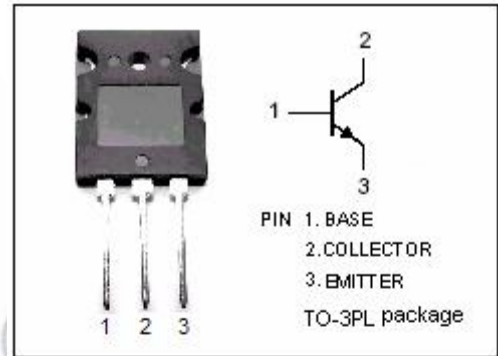

isc Silicon NPN Power Transistor

2SC3989

ELECTRICAL CHARACTERISTICS

 $T_c=25^\circ\text{C}$ unless otherwise specified

SYMBOL	PARAMETER	CONDITIONS	MIN	TYP.	MAX	UNIT
$V_{(BR)CEO}$	Collector-Emitter Breakdown Voltage	$I_C=5\text{mA}; I_B=0$	500			V
$V_{(BR)CBO}$	Collector-Base Breakdown Voltage	$I_C=1\text{mA}; I_E=0$	800			V
$V_{(BR)EBO}$	Emitter-Base Breakdown Voltage	$I_E=1\text{mA}; I_C=0$	7			V
$V_{CE(sat)}$	Collector-Emitter Saturation Voltage	$I_C=12\text{A}; I_B=2.4\text{A}$			1.0	V
$V_{BE(sat)}$	Base-Emitter Saturation Voltage	$I_C=12\text{A}; I_B=2.4\text{A}$			1.5	V
I_{CBO}	Collector Cutoff Current	$V_{CB}=500\text{V}; I_E=0$			10	μA
I_{EBO}	Emitter Cutoff Current	$V_{EB}=5\text{V}; I_C=0$			10	μA
h_{FE-1}	DC Current Gain	$I_C=2.4\text{A}; V_{CE}=5\text{V}$	15		50	
h_{FE-2}	DC Current Gain	$I_C=12\text{A}; V_{CE}=5\text{V}$	8			
f_T	Current-Gain—Bandwidth Product	$I_C=2.4\text{A}; V_{CE}=10\text{V}$		18		MHz
C_{OB}	Output Capacitance	$I_E=0; V_{CB}=10\text{V}$		260		pF

◆ h_{FE-1} Classifications

L	M	N
15-30	20-40	30-50