

## SI-3001N Series

# 3-Terminal, Full-Mold, Low Dropout Voltage Dropper Type

### ■Features

- Compact full-mold package (equivalent to TO220)
- Output current: 1.5A
- Low dropout voltage:  $V_{DIF} \leq 1V$  (at  $I_o=1.5A$ )
- Built-in foldback overcurrent, overvoltage, thermal protection circuits

### ■Applications

- For stabilization of the secondary stage of switching power supplies
- Electronic equipment

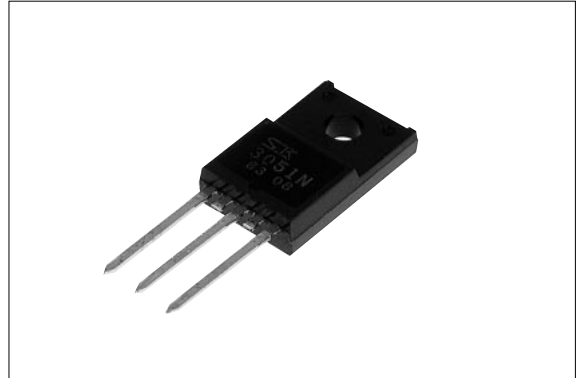

### ■Absolute Maximum Ratings

( $T_a=25^\circ C$ )

Parameter	Symbol	Ratings			Unit
		SI-3051N/3091N	SI-3121N/3151N	SI-3241N	
DC Input Voltage	$V_{IN}$	35	35	45	V
DC Output Current	$I_o$	1.5 <sup>2</sup>			A
Power Dissipation	$P_{D1}$	18(With infinite heatsink)			W
	$P_{D2}$	1.5(Without heatsink, stand-alone operation)			W
Junction Temperature	$T_j$	-40 to +125			$^\circ C$
Ambient Operating Temperature	$T_{op}$	-30 to +100			$^\circ C$
Storage Temperature	$T_{stg}$	-40 to +125			$^\circ C$
Thermal Resistance (junction to case)	$R_{th(j-c)}$	5.5			$^\circ C/W$
Thermal Resistance (junction to ambient air)	$R_{th(j-a)}$	66.7(Without heatsink, stand-alone operation)			$^\circ C/W$

■Electrical Characteristics

(Ta=25°C unless otherwise specified)

Parameter	Symbol	Ratings														Unit	
		SI-3051N			SI-3091N			SI-3121N			SI-3151N			SI-3241N			
		min.	typ.	max.	min.	typ.	max.	min.	typ.	max.	min.	typ.	max.	min.	typ.		max.
Input Voltage	V <sub>IN</sub>	6 <sup>3</sup>		30 <sup>2</sup>	10 <sup>3</sup>		30 <sup>2</sup>	13 <sup>3</sup>		30 <sup>2</sup>	16 <sup>3</sup>		30 <sup>2</sup>	25 <sup>3</sup>		40 <sup>2</sup>	V
Output Voltage	SI-3001N *1	4.80	5.00	5.20	8.64	9.00	9.36	11.52	12.00	12.48	14.40	15.00	15.60	23.04	24.00	24.96	V
	SI-3001NA	4.90	5.00	5.10	8.82	9.00	9.18	11.76	12.00	12.24	14.70	15.00	15.30	23.52	24.00	24.48	
Dropout Voltage	V <sub>DIF</sub>			0.5			0.5			0.5			0.5			0.5	V
	Conditions	V <sub>IN</sub> =8V, I <sub>O</sub> =1.0A			V <sub>IN</sub> =12V, I <sub>O</sub> =1.0A			V <sub>IN</sub> =15V, I <sub>O</sub> =1.0A			V <sub>IN</sub> =18V, I <sub>O</sub> =1.0A			V <sub>IN</sub> =27V, I <sub>O</sub> =1.0A			
	Conditions	I <sub>O</sub> ≤1.0A															
Line Regulation	ΔV <sub>OLINE</sub>		10	30		18	48		24	64		30	90		48	128	mV
	Conditions	V <sub>IN</sub> =6V to 15V, I <sub>O</sub> =1.0A			V <sub>IN</sub> =10V to 20V, I <sub>O</sub> =1.0A			V <sub>IN</sub> =13V to 25V, I <sub>O</sub> =1.0A			V <sub>IN</sub> =16V to 27V, I <sub>O</sub> =1.0A			V <sub>IN</sub> =25V to 38V, I <sub>O</sub> =1.0A			
	Conditions	I <sub>O</sub> ≤1.5A															
Load Regulation	ΔV <sub>OLOAD</sub>		40	100		70	180		93	240		120	300		120	300	mV
	Conditions	V <sub>IN</sub> =8V, I <sub>O</sub> =0 to 1.5A			V <sub>IN</sub> =12V, I <sub>O</sub> =0 to 1.5A			V <sub>IN</sub> =15V, I <sub>O</sub> =0 to 1.5A			V <sub>IN</sub> =18V, I <sub>O</sub> =0 to 1.5A			V <sub>IN</sub> =27V, I <sub>O</sub> =0 to 1.5A			
Temperature Coefficient of Output Voltage	ΔV <sub>O</sub> /ΔT <sub>a</sub>		±0.5			±1.0			±1.5			±1.5			±2.5		mV/°C
	Conditions	V <sub>IN</sub> =8V, I <sub>O</sub> =5mA, T <sub>i</sub> =0 to 100°C			V <sub>IN</sub> =12V, I <sub>O</sub> =5mA, T <sub>i</sub> =0 to 100°C			V <sub>IN</sub> =15V, I <sub>O</sub> =5mA, T <sub>i</sub> =0 to 100°C			V <sub>IN</sub> =18V, I <sub>O</sub> =5mA, T <sub>i</sub> =0 to 100°C			V <sub>IN</sub> =27V, I <sub>O</sub> =5mA, T <sub>i</sub> =0 to 100°C			
Ripple Rejection	R <sub>REJ</sub>		54			54			54			54			54		dB
	Conditions	V <sub>IN</sub> =8V, f=100 to 120Hz			V <sub>IN</sub> =12V, f=100 to 120Hz			V <sub>IN</sub> =15V, f=100 to 120Hz			V <sub>IN</sub> =18V, f=100 to 120Hz			V <sub>IN</sub> =27V, f=100 to 120Hz			
Quiescent Circuit Current	I <sub>q</sub>		5	10		5	10		5	10		5	10		5	10	mA
	Conditions	V <sub>IN</sub> =8V, I <sub>O</sub> =0A			V <sub>IN</sub> =12V, I <sub>O</sub> =0A			V <sub>IN</sub> =15V, I <sub>O</sub> =0A			V <sub>IN</sub> =18V, I <sub>O</sub> =0A			V <sub>IN</sub> =27V, I <sub>O</sub> =0A			
Overcurrent Protection Starting Current*4,5	I <sub>S1</sub>	1.6			1.6			1.6			1.6			1.6			A
	Conditions	V <sub>IN</sub> =8V			V <sub>IN</sub> =12V			V <sub>IN</sub> =15V			V <sub>IN</sub> =18V			V <sub>IN</sub> =27V			

\*1: "A" may be indicated to the right of the Sanken logo.

\*2: V<sub>IN(max)</sub> and I<sub>O(max)</sub> are restricted by the relation P<sub>D(max)</sub>=(V<sub>IN</sub>-V<sub>O</sub>)•I<sub>O</sub>=18(W).

\*3: Refer to the dropout voltage.(Refer to Setting DC Input Voltage on page 7.)

\*4: I<sub>S1</sub> is specified at -5(%) drop point of output voltage V<sub>O</sub> on the condition that V<sub>IN</sub>=V<sub>O</sub>+3V, I<sub>O</sub>=1A.

\*5: A foldback type overcurrent protection circuit is built into the IC regulator. Therefore, avoid using it for the following applications as it may cause starting errors:

- (1) Constant current load (2) Plus/minus power (3) Series power (4) V<sub>O</sub> adjustment by raising ground voltage

■Outline Drawing

(unit:mm)

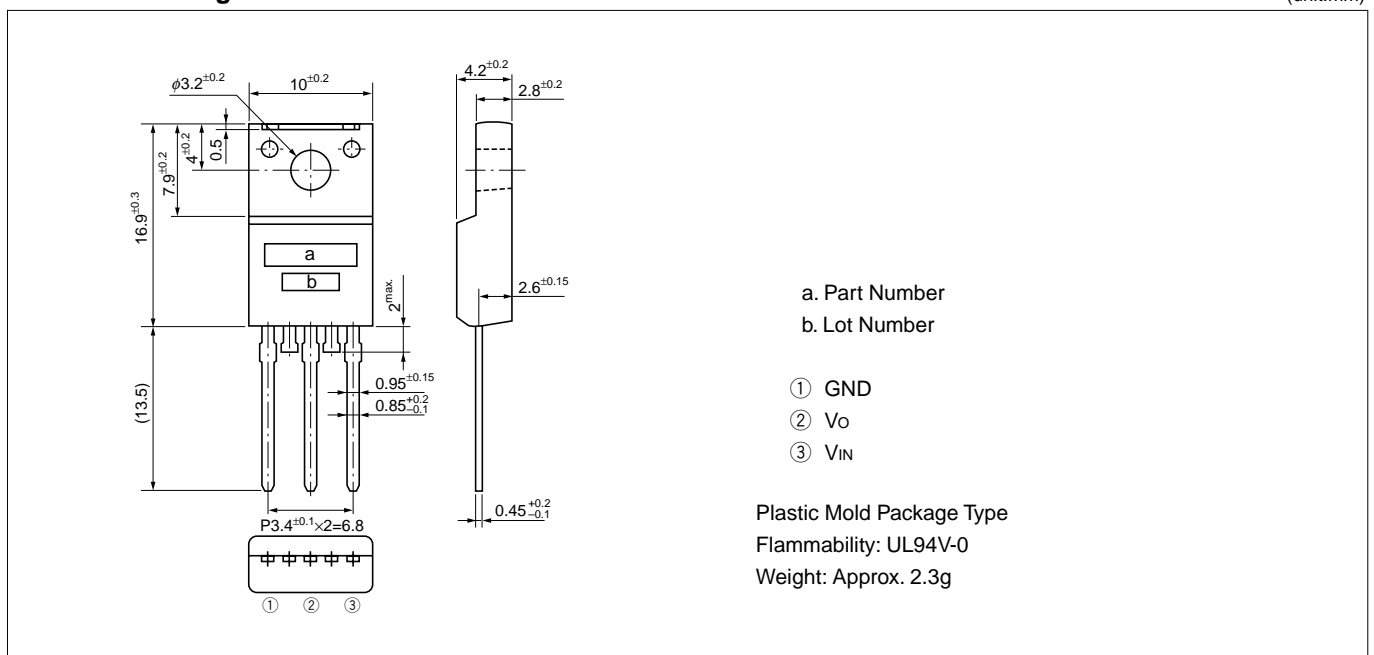

■Block Diagram

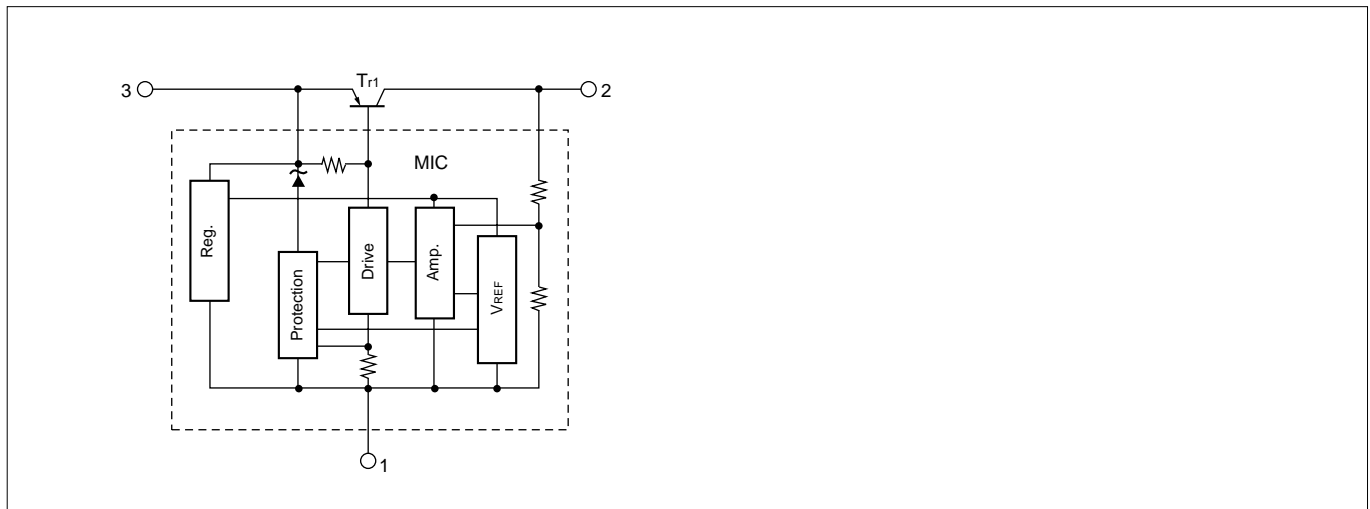

■Standard External Circuit

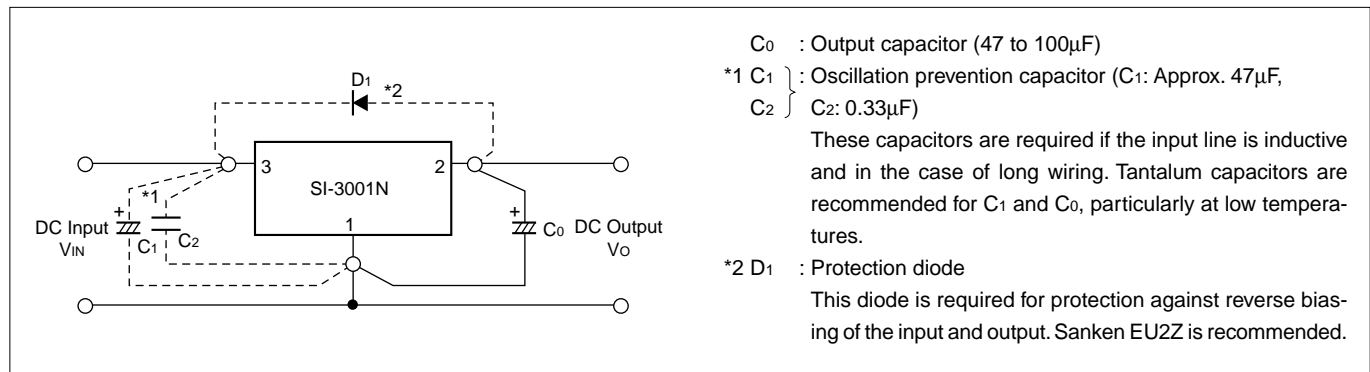

■ $T_a$ - $P_D$  Characteristics

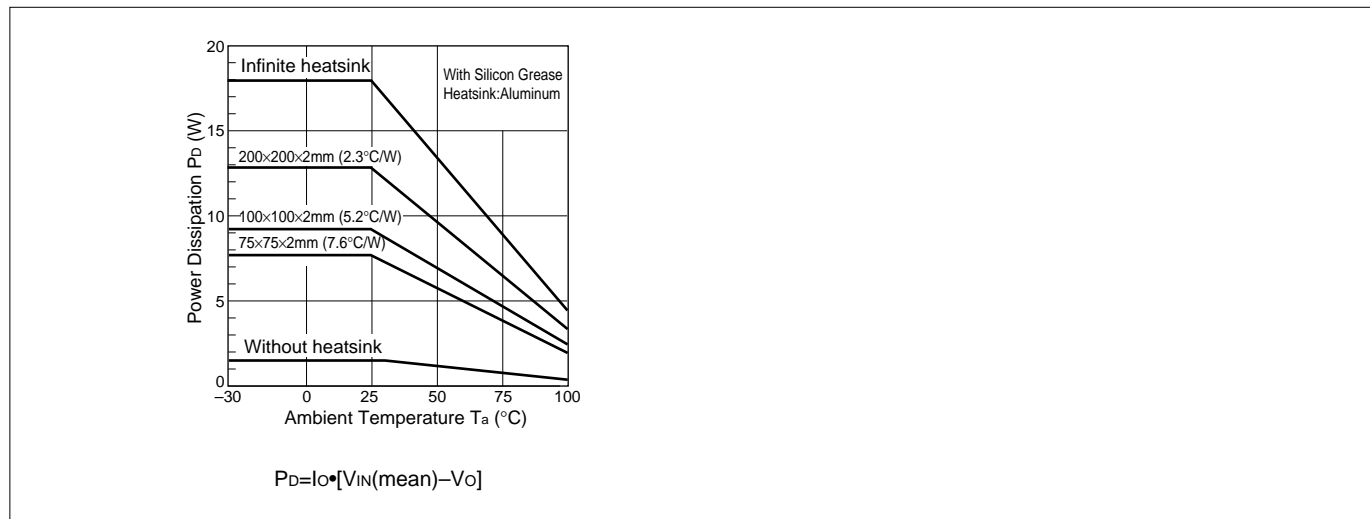

■Typical Characteristics

( $T_a=25^\circ\text{C}$ )

Io vs. VdIF Characteristics

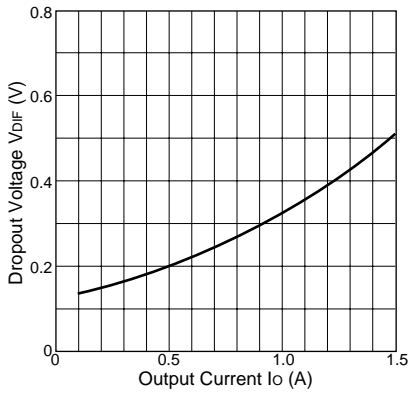

Temperature Coefficient of Output Voltage(SI-3051N)

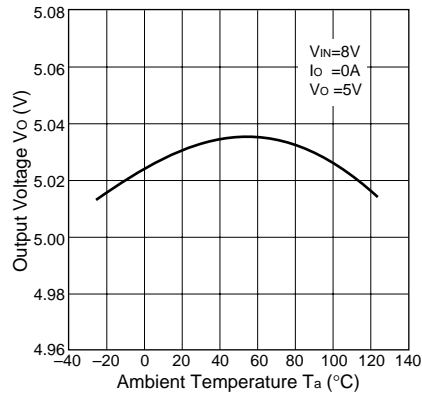

Circuit Current(SI-3051N)

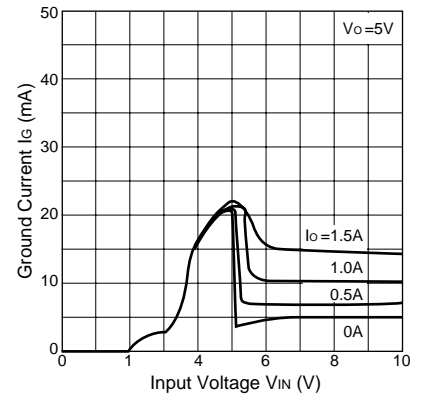

Rise Characteristics(SI-3051N)

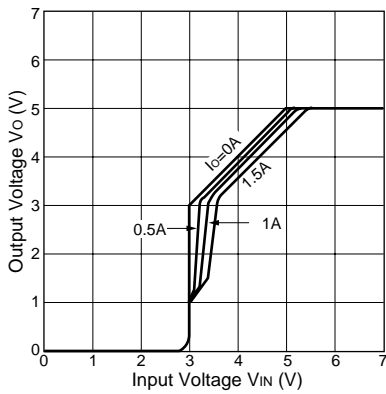

Rise Characteristics(SI-3121N)

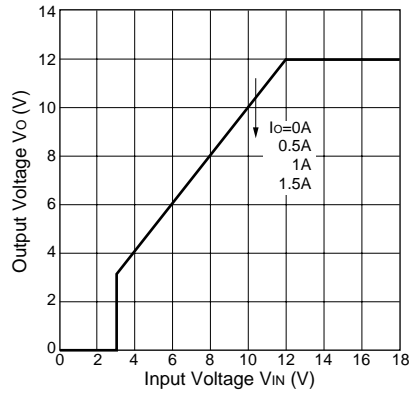

Rise Characteristics(SI-3241N)

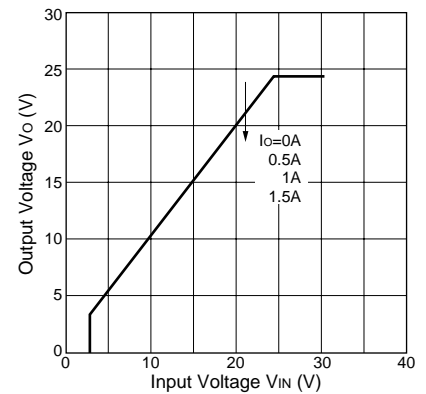

Overcurrent Protection Characteristics(SI-3051N)

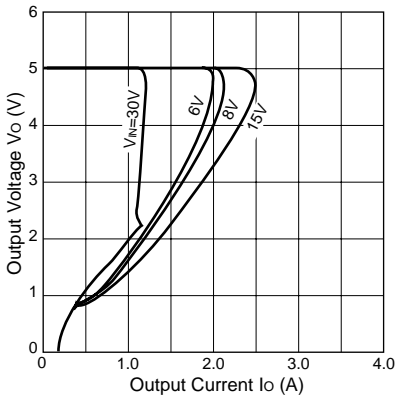

Overcurrent Protection Characteristics(SI-3121N)

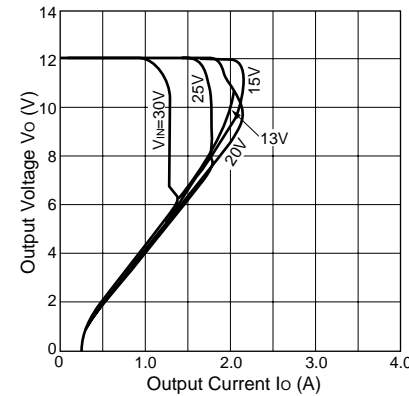

Overcurrent Protection Characteristics(SI-3241N)

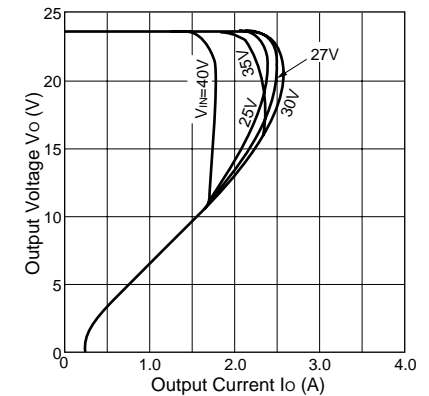

Thermal Protection Characteristics(SI-3051N)

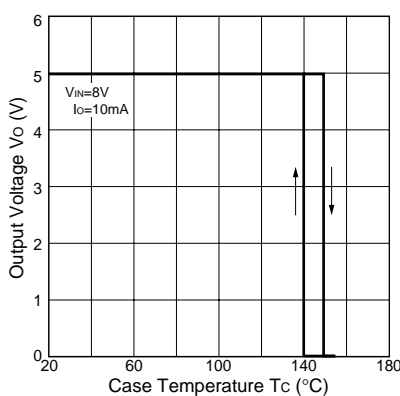

**Note on Thermal Protection:**

The thermal protection circuit is intended for protection against heat during instantaneous short-circuiting. Its operation is not guaranteed for short-circuiting over extended periods of time.