

SMD Power Inductor CDRH2D09C

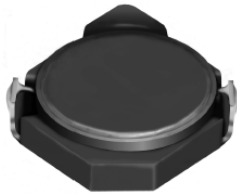

Halogen Free



Description

- Ferrite drum core construction.
- Magnetically shielded.
- L × W × H: 3.2 × 3.2 × 1.0 mm Max.
- Product weight: 28mg(Ref.)
- Moisture Sensitivity Level: 1
- RoHS compliance.
- Halogen Free available.

Environmental Data

- Operating temperature range: -40°C~+105°C (including coil's self temperature rise)
- Storage temperature range: -40°C~+105°C
- Solder reflow temperature: 260 °C peak.

Packaging

- Carrier tape and reel packaging
- 7.0" diameter reel
- 1500pcs per reel

Applications

- Ideally used in Mobilephone, PDA, MP3, DSC/DVC, etc as DC-DC converter inductors.

Dimension - [mm]

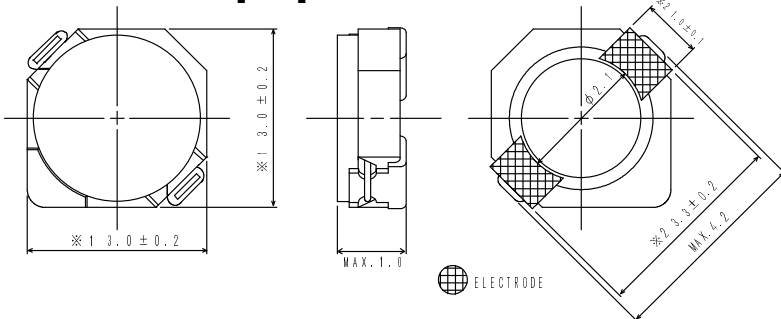

Land pattern and Schematics - [mm]

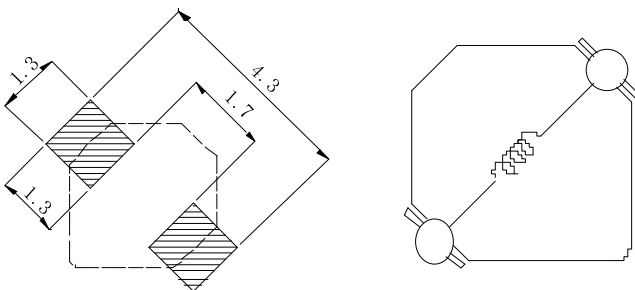

SMD Power Inductor CDRH2D09C



Electrical Characteristics

Part Name	Stamp	Inductance (μ H) [within] ※1	D.C.R.(Ω) Max. (Typ.) (at 20°C)	Saturation Current (A) ※2		Temperature Rise Current (A) ※3
				at 20°C	at 105°C	
CDRH2D09CNP-1R2NC	A	1.2 \pm 25%	78m(62.4m)	0.83	0.64	1.55
CDRH2D09CNP-1R5NC	B	1.5 \pm 25%	88m(70.6m)	0.70	0.52	1.35
CDRH2D09CNP-2R4NC	D	2.4 \pm 25%	119m(95.0m)	0.58	0.45	1.10
CDRH2D09CNP-3R3NC	F	3.3 \pm 25%	174m(139m)	0.50	0.38	0.90
CDRH2D09CNP-4R7NC	H	4.7 \pm 25%	238m(190m)	0.38	0.30	0.80
CDRH2D09CNP-6R4NC	K	6.4 \pm 25%	290m(232m)	0.36	0.27	0.65
CDRH2D09CNP-8R2NC	L	8.2 \pm 25%	0.40(0.32)	0.31	0.25	0.56
CDRH2D09CNP-100NC	M	10 \pm 25%	0.50(0.40)	0.30	0.23	0.51
CDRH2D09CNP-120NC	N	12 \pm 25%	0.55(0.44)	0.27	0.20	0.45
CDRH2D09CNP-150NC	P	15 \pm 25%	0.65(0.52)	0.24	0.18	0.42
CDRH2D09CNP-180NC	Q	18 \pm 25%	0.77(0.61)	0.22	0.17	0.38
CDRH2D09CNP-220NC	R	22 \pm 25%	0.94(0.75)	0.20	0.15	0.35
CDRH2D09CNP-270NC	S	27 \pm 25%	1.11(0.88)	0.16	0.12	0.32

※1. Inductance measuring condition: at 100kHz.

※2. Saturation current: The value of D.C. current when the inductance decreases to 65% of its nominal value.

※3. Temperature rise current: The value of D.C. current when the temperature rise is $\Delta t=40^{\circ}\text{C}$ ($T_a=20^{\circ}\text{C}$).

SMD Power Inductor CDRH2D09C



Saturation Current & Temperature Rise Graph

— L (20°C) — L (105°C) — ΔT

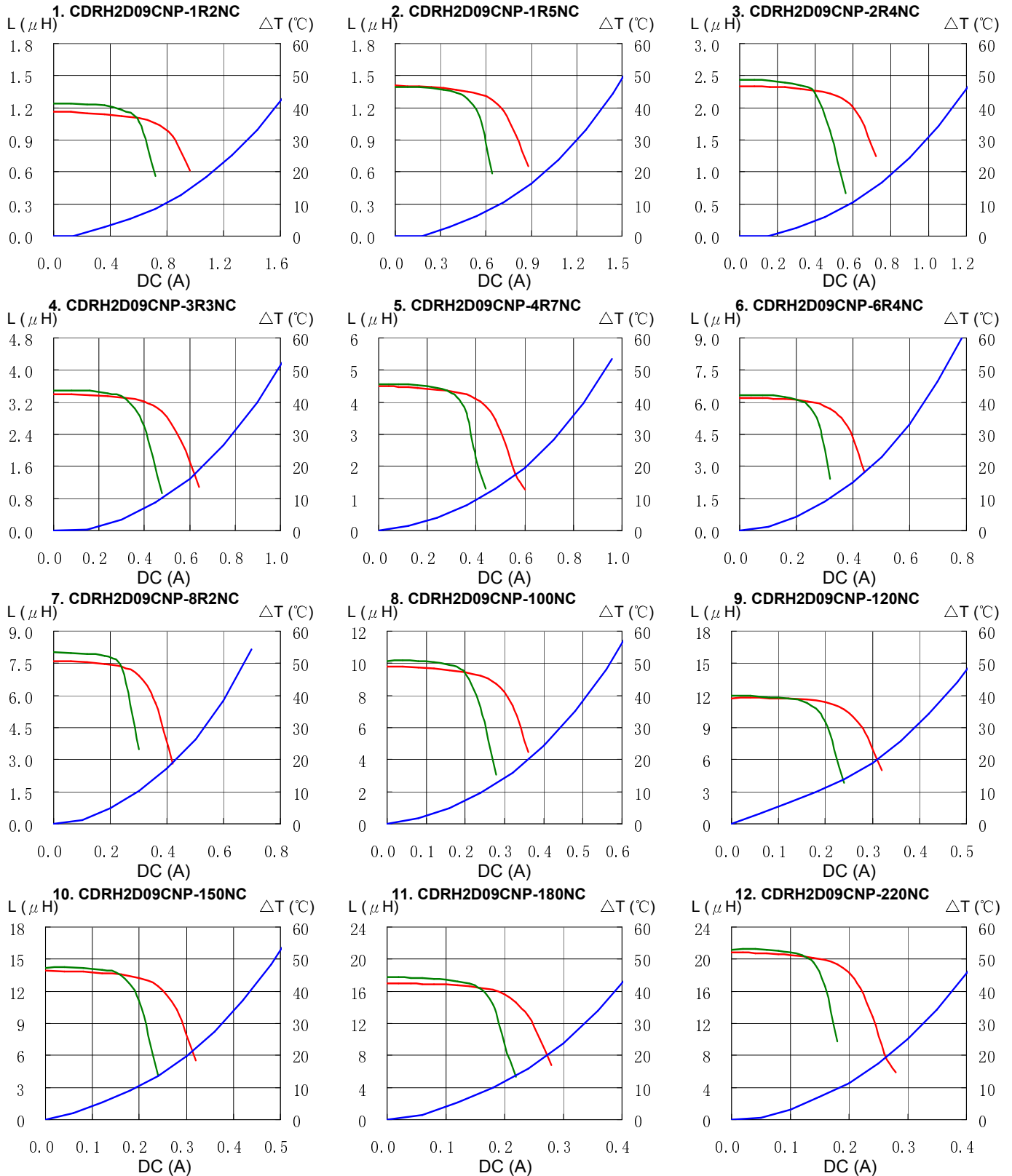

SMD Power Inductor CDRH2D09C



Saturation Current & Temperature Rise Graph

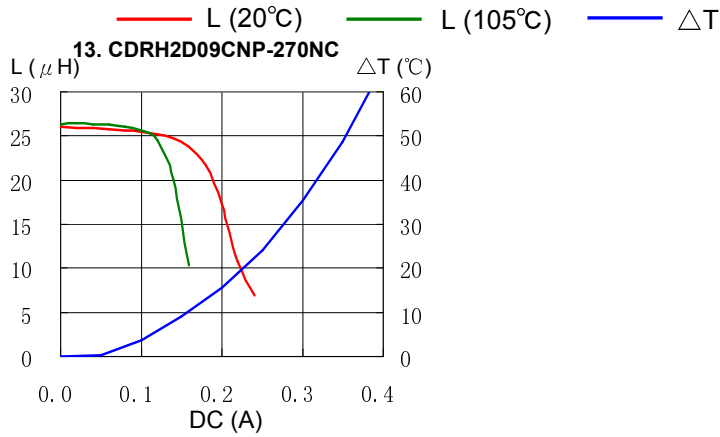

Solder Reflow Condition

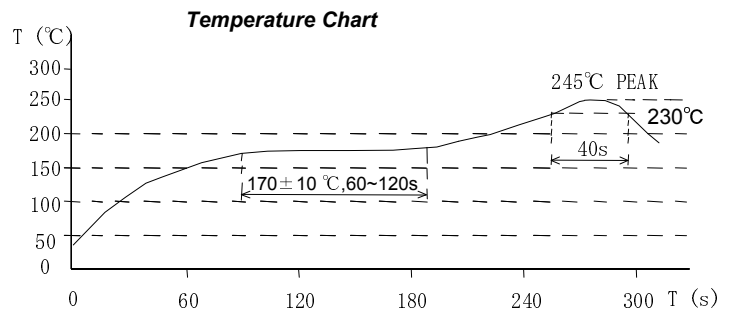
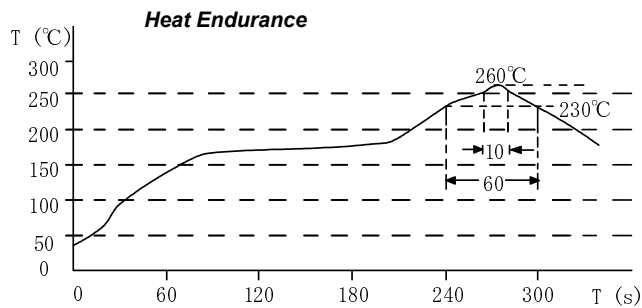

Please refer to the sales offices on our website - <http://www.sumida.com>

Hong Kong
Tel.+852-2880-6781
FAX.+852-2565-9600
sales@hk.sumida.com

Saitama(Japan)
Tel.+81-48-691-7300
FAX.+81-48-691-7340
sales@jp.sumida.com

Chicago
Tel.+1-847-545-6700
FAX. +1-847-545-6720
sales@us.sumida.com

Shanghai
Tel.+86-21-5836-3299
FAX.+86-21-5836-3266
shanghai.sales@cn.sumida.com

Seoul
Tel.+82-2-6237-0777
FAX.+82-2-6237-0778
sales@kr.sumida.com

Oberzell
Tel.+49-8591-937-0
FAX. +49-8591-937-103
contact@eu.sumida.com

Shenzhen
Tel.+86-755-8291-0228
FAX.+86-755-8291-0338
shenzhen.sales@cn.sumida.com

Singapore
Tel.+65-6296-3388
FAX.+65-6841-4426
sales@sg.sumida.com

Neumarkt
Tel.+49-9181-4509-110
FAX. +49-9181-4509-310
infocomp@eu.sumida.com

Taipei
Tel.+886-2-8751-2737
FAX.+886-2-8751-2738
sales@tw.sumida.com

San Jose
Tel.+1-408-321-9660
FAX.+1-408-321-9308
sales@us.sumida.com