



### Product Description

The SGA3586Z is a high performance SiGe HBT MMIC Amplifier. A Darlington configuration featuring one-micron emitters provides high  $F_T$  and excellent thermal performance. The heterojunction increases breakdown voltage and minimizes leakage current between junctions. Cancellation of emitter junction non-linearities results in higher suppression of intermodulation products. Only two DC-blocking capacitors, a bias resistor, and an optional RF choke are required for operation.

#### Optimum Technology Matching® Applied

- GaAs HBT
- GaAs MESFET
- InGaP HBT
- SiGe BiCMOS
- Si BiCMOS
- SiGe HBT
- GaAs pHEMT
- Si CMOS
- Si BJT
- GaN HEMT
- RF MEMS

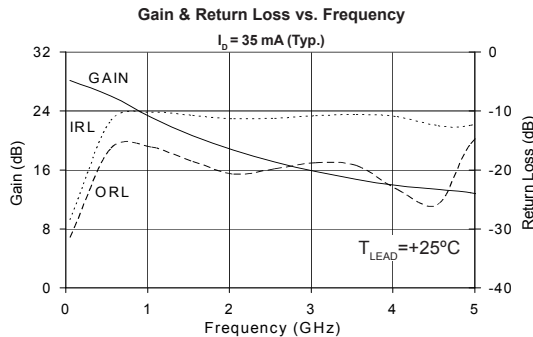

### Features

- High Gain: 25dB at 850MHz
- Cascadable 50Ω Gain Block
- High Output  $IP_3$ : 25dBm typ. at 1950MHz
- Low Noise Figure: 2.5dB typ. at 1950MHz
- Low Current Draw: 35mA typ.
- Single Voltage Supply Operation

### Applications

- PA Driver Amplifier
- Cellular, PCS, GSM, UMTS
- IF Amplifier
- Wireless Data, Satellite

Parameter	Specification			Unit	Condition
	Min.	Typ.	Max.		
Small Signal Gain	22.5	25.0	27.5	dB	850MHz
	18.0	20.0	22.0	dB	1950MHz
		18.5		dB	2400MHz
Output Power at 1dB Compression		13.0		dBm	850MHz
	11.0	12.5		dBm	1950MHz
Output Third Intercept Point		24.5		dBm	850MHz
	23.0	25.0		dBm	1950MHz
Bandwidth Determined by Return Loss		5000		MHz	>10dB
Input Return Loss	9.5	11.0		dB	1950MHz
Output Return Loss	14.0	20.0		dB	1950MHz
Noise Figure		2.5	3.5	dB	1950MHz
Device Operating Voltage	3.0	3.25	3.5	V	
Device Operating Current	31	35	39	mA	
Thermal Resistance (Junction - Lead)		97		°C/W	

Test Conditions:  $I_b = 35\text{mA Typ.}$ ,  $T_{LEAD} = 25^\circ\text{C}$ ,  $Z_S = Z_L = 50\Omega$ ,  $P_{OUT}$  per tone = -5dBm,  $OIP_3$  Tone Spacing = 1MHz

## Absolute Maximum Ratings

Parameter	Rating	Unit
Max Device Current ( $I_D$ )	70	mA
Max Device Voltage ( $V_D$ )	6	V
Max RF Input Power	+18	dBm
Max Junction Temp ( $T_J$ )	+150	°C
Operating Temp Range ( $T_L$ )	-55 to +110	°C
Max Storage Temp	+150	°C

Operation of this device beyond any one of these limits may cause permanent damage. For reliable continuous operation, the device voltage and current must not exceed the maximum operating values specified in the table on page one.

Bias Conditions should also satisfy the following expression:

$$I_D V_D < (T_J - T_L) / R_{TH, J-H}$$



**Caution!** ESD sensitive device.

Exceeding any one or a combination of the Absolute Maximum Rating conditions may cause permanent damage to the device. Extended application of Absolute Maximum Rating conditions to the device may reduce device reliability. Specified typical performance or functional operation of the device under Absolute Maximum Rating conditions is not implied.

The information in this publication is believed to be accurate and reliable. However, no responsibility is assumed by RF Micro Devices, Inc. ("RFMD") for its use, nor for any infringement of patents, or other rights of third parties, resulting from its use. No license is granted by implication or otherwise under any patent or patent rights of RFMD. RFMD reserves the right to change component circuitry, recommended application circuitry and specifications at any time without prior notice.



65/EURFMD Green: RoHS compliant per EU Directive 2011/65/EU, halogen free per IEC 61249-2-21, < 1000ppm each of antimony trioxide in polymeric materials and red phosphorus as a flame retardant, and <2% antimony in solder.

## Typical Performance at Key Operating Frequencies

Parameter	Unit	100 MHz	500 MHz	850 MHz	1950 MHz	2400 MHz	3500 MHz
Small Signal Gain	dB	28.2	27.1	25.0	19.7	18.3	14.8
Output Third Order Intercept Point	dBm	23.8	23.9	24.5	25.0	25.5	
Output Power at 1dB Compression	dBm	13.0	13.0	13.0	12.5	12.5	
Input Return Loss	dB	28.4	12.8	10.7	10.5	11.1	10.6
Output Return Loss	dB	31.5	17.1	15.9	20.5	20.3	18.9
Reverse Isolation	dB	29.4	29.0	28.1	24.1	22.4	19.2
Noise Figure	dB		2.4	2.5	2.5	2.5	

Test Conditions:  $I_D = 35$  mA Typ.,  $OIP_3$  Tone Spacing = 1 MHz,  $P_{OUT}$  per tone = -5 dBm,  $R_{BIAS} = 100 \Omega$ ,  $T_L = 25^\circ C$ ,  $Z_S = Z_L = 50 \Omega$

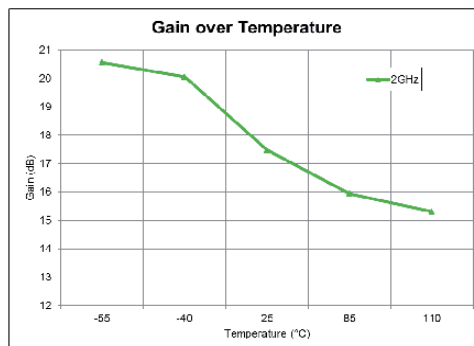
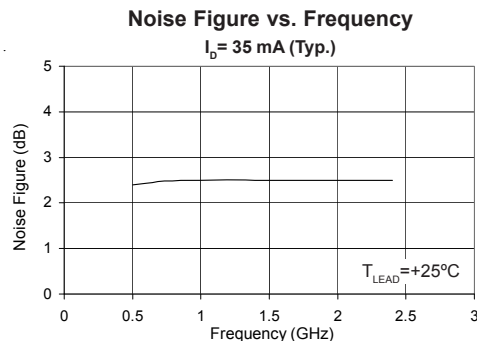
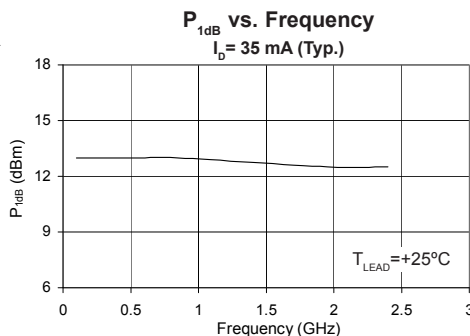
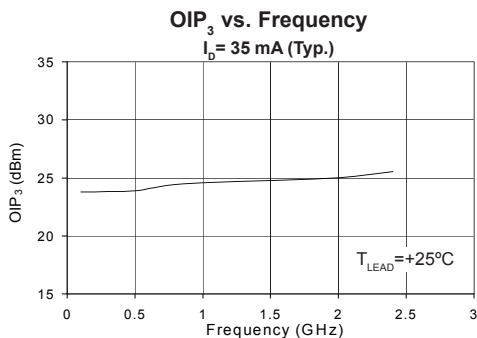

Typical RF Performance Over Lead Temperature -- Bias:  $I_b = 35$  mA (Typ.) at  $T_{LEAD} = +25^\circ\text{C}$

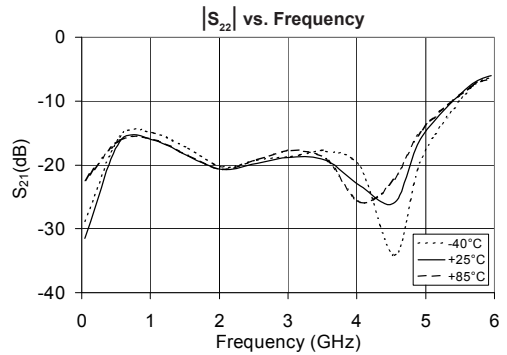
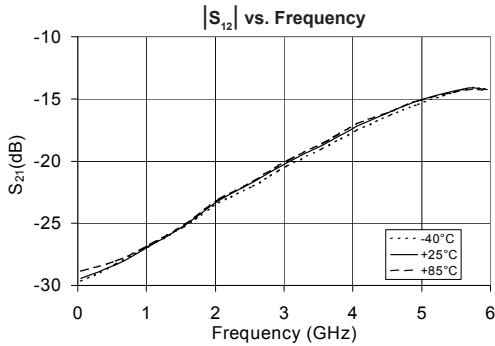
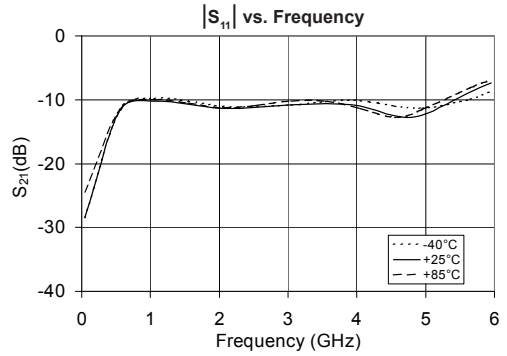
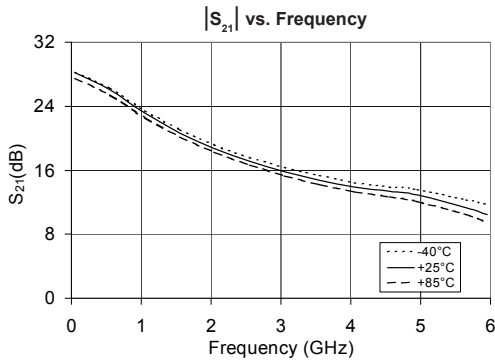

Pin	Function	Description
1	RF IN	RF input pin. This pin requires the use of an external DC-blocking capacitor chosen for the frequency of operation.
2, 4	GND	Connection to ground. For optimum RF performance, use via holes as close to ground leads as possible to reduce lead inductance.
3	RF OUT/BIAS	RF output and bias pin. DC voltage is present on this pin, therefore a DC-blocking capacitor is necessary for proper operation.

## Suggested Pad Layout

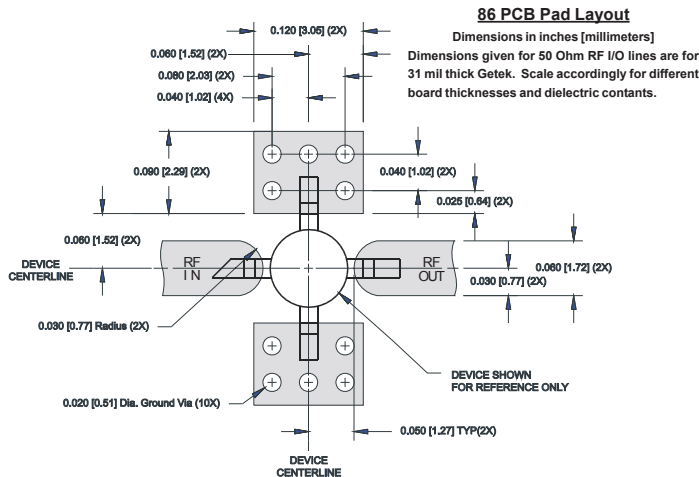

## Package Drawing

Dimensions in inches (millimeters)  
 Refer to drawing posted at [www.rfmd.com](http://www.rfmd.com) for tolerances.

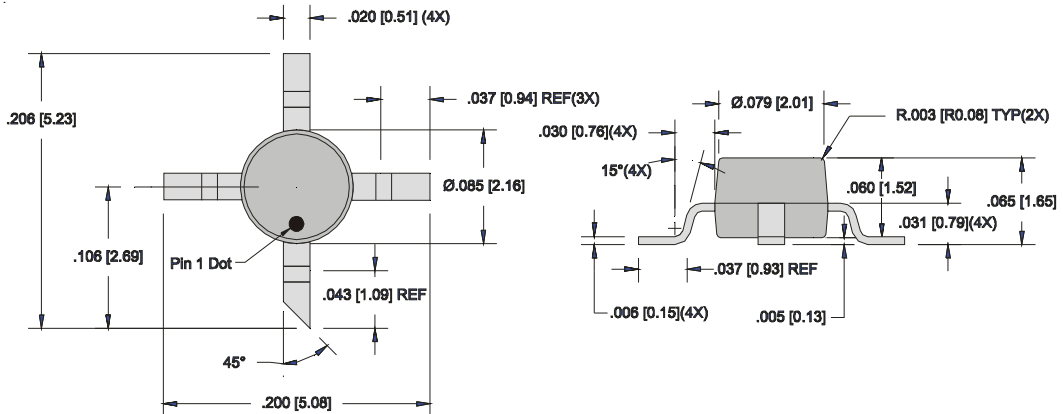

**Application Schematic**

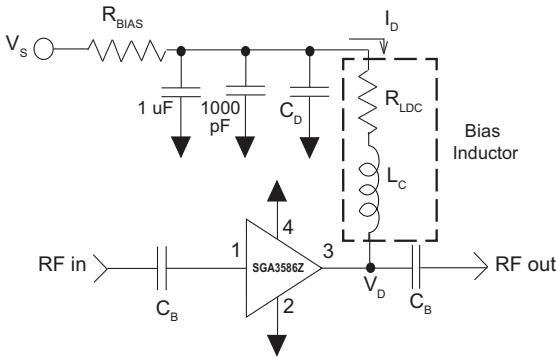

Application Circuit Element Values						
Reference Designator	Frequency (Mhz)					
	100	500	850	1950	2400	3500
C <sub>B</sub>	1000 pF	220 pF	100 pF	68 pF	56 pF	39 pF
C <sub>D</sub>	100 pF	100 pF	68 pF	22 pF	22 pF	15 pF
L <sub>C</sub>	470 nH	68 nH	33 nH	22 nH	18 nH	15 nH

Recommended Bias Resistance for I <sub>b</sub> = 35 mA							
Supply Voltage (V <sub>s</sub> ) (Volts)	< 5	5	6	7	8	9	10
Bias Resistance* (Ohms)	N/R	50	79	107	136	164	193

\* Bias Resistance =  $R_{BIAS} + R_{LDC} = (V_s - V_D) / I_D$   
 Select  $R_{BIAS}$  so that  $R_{BIAS} + R_{LDC} \sim$  the recommended bias resistance. Use 1% or 5% tolerance resistors or parallel combinations to attain the recommended bias resistance +/- 3%.  $R_{BIAS}$  provides current stability over temperature.

\* N/R=Not Recommended. Contact Sirenza technical support for guidance when available supply voltage is less than 5 Volts.

**Evaluation Board Layout**

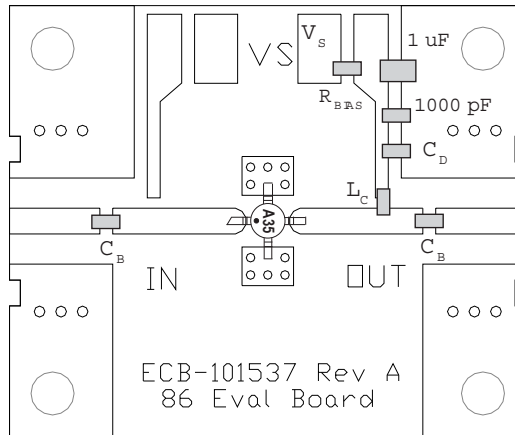

## Part Identification

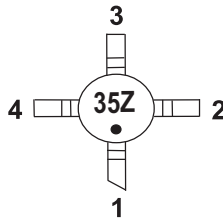

## Ordering Information

Ordering Code	Description
SGA3586Z	13" Reel with 3000 pieces
SGA3586ZSQ	Sample bag with 25 pieces
SGA3586ZSR	7" Reel with 100 pieces
SGA3586ZPCK1	850MHz, 5V Operation PCBA with 5-piece sample bag