

700V(D-S) N-Channel Enhancement Mode Power MOS FET

General Features

- $V_{DS} = 700V, I_D = 2A$
 $R_{DS(ON)} < 6.5 \Omega @ V_{GS} = 10V$
- High density cell design for ultra low R_{dson}
- Fully characterized avalanche voltage and current
- Good stability and uniformity with high E_{AS}
- Excellent package for good heat dissipation
- Special process technology for high ESD capability



Lead Free

Application

- Power switching application
- Hard switched and high frequency circuits
- Electronic ballast and transformer

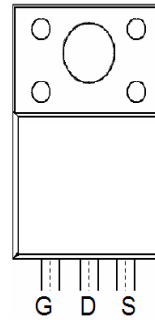

Marking and pin assignment

PIN Configuration



TO-220F top view

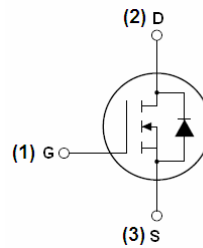

Schematic diagram

Package Marking and Ordering Information

Device Marking	Device	Device Package	Reel Size	Tape width	Quantity
MSN7002F	MSN7002F	TO-220F	-	-	-

Absolute Maximum Ratings ($T_C = 25^\circ C$ unless otherwise noted)

Parameter	Symbol	Limit	Unit
Drain-Source Voltage	V_{DS}	700	V
Gate-Source Voltage	V_{GS}	± 30	V
Drain Current-Continuous	I_D	2	A
Drain Current-Continuous($T_C = 100^\circ C$)	$I_D(100^\circ C)$	1.25	A
Pulsed Drain Current	I_{DM}	8	A
Maximum Power Dissipation	P_D	28	W
Derating factor		0.20	W/ $^\circ C$
Single pulse avalanche energy ^(Note 5)	E_{AS}	120	mJ
Operating Junction and Storage Temperature Range	T_J, T_{STG}	-55 To 150	$^\circ C$

Thermal Characteristic

Thermal Resistance, Junction-to-Case ^(Note 2)	$R_{\theta JC}$	4.46	$^{\circ}C/W$
--	-----------------	------	---------------

Electrical Characteristics ($T_C=25^{\circ}C$ unless otherwise noted)

Parameter	Symbol	Condition	Min	Typ	Max	Unit
Off Characteristics						
Drain-Source Breakdown Voltage	BV_{DSS}	$V_{GS}=0V, I_D=250\mu A$	700	-	-	V
Zero Gate Voltage Drain Current	I_{DSS}	$V_{DS}=700V, V_{GS}=0V$	-	-	25	μA
Gate-Body Leakage Current	I_{GSS}	$V_{GS}=\pm 30V, V_{DS}=0V$	-	-	± 100	nA
On Characteristics ^(Note 3)						
Gate Threshold Voltage	$V_{GS(th)}$	$V_{DS}=V_{GS}, I_D=250\mu A$	2	-	4	V
Drain-Source On-State Resistance	$R_{DS(on)}$	$V_{GS}=10V, I_D=1.0A$	-	5.5	6.5	Ω
Forward Transconductance	g_{FS}	$V_{DS}=40V, I_D=1.0A$	-	1.5	-	S
Dynamic Characteristics ^(Note 4)						
Input Capacitance	C_{iss}	$V_{DS}=25V, V_{GS}=0V,$ $F=1.0MHz$	-	290	-	PF
Output Capacitance	C_{oss}		-	31	-	PF
Reverse Transfer Capacitance	C_{rss}		-	9	-	PF
Switching Characteristics ^(Note 4)						
Turn-on Delay Time	$t_{d(on)}$	$V_{DD}=300V, I_D=2A, R_L=25\Omega$ $V_{GS}=10V, R_G=2.5\Omega$	-	10	-	nS
Turn-on Rise Time	t_r		-	25	-	nS
Turn-Off Delay Time	$t_{d(off)}$		-	24	-	nS
Turn-Off Fall Time	t_f		-	26	-	nS
Total Gate Charge	Q_g	$V_{DS}=560V, I_D=2A,$ $V_{GS}=10V$	-	14.5	-	nC
Gate-Source Charge	Q_{gs}		-	1.8	-	nC
Gate-Drain Charge	Q_{gd}		-	8.3	-	nC
Drain-Source Diode Characteristics						
Diode Forward Voltage ^(Note 3)	V_{SD}	$V_{GS}=0V, I_S=2.0A$	-	-	1.4	V
Diode Forward Current ^(Note 2)	I_S		-	-	2.0	A
Reverse Recovery Time	t_{rr}	$T_J = 25^{\circ}C, I_F = 2.0A$ $di/dt = 100A/\mu s$ ^(Note 3)	-	380	-	nS
Reverse Recovery Charge	Q_{rr}		-	0.9	-	μC
Forward Turn-On Time	t_{on}	Intrinsic turn-on time is negligible (turn-on is dominated by LS+LD)				

Notes:

1. Repetitive Rating: Pulse width limited by maximum junction temperature.
2. Surface Mounted on FR4 Board, $t \leq 10$ sec.
3. Pulse Test: Pulse Width $\leq 300\mu s$, Duty Cycle $\leq 2\%$.
4. Guaranteed by design, not subject to production
5. E_{AS} condition: $j=25^{\circ}C, V_{DD}=50V, V_G=10V, L=0.5mH, R_g=25\Omega$

Typical Electrical and Thermal Characteristics (Curves)

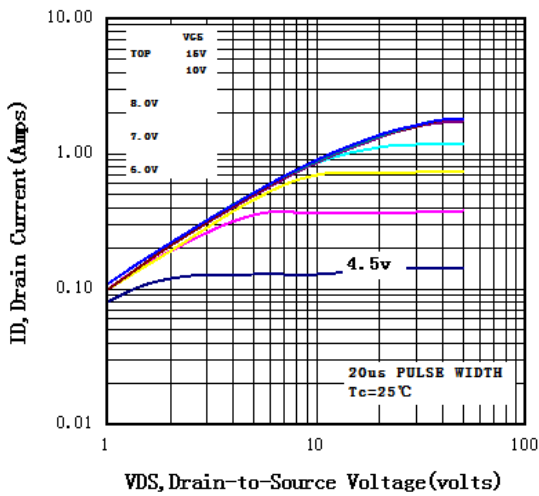

Fig1 Typical Output Characteristics, Tc=25°C

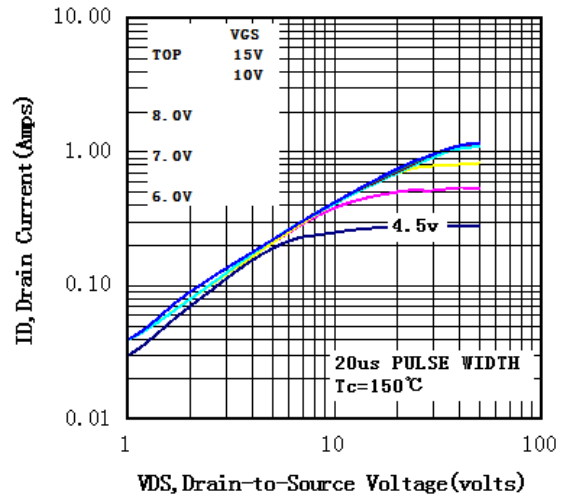

Fig2 Typical Output Characteristics, Tc=150°C

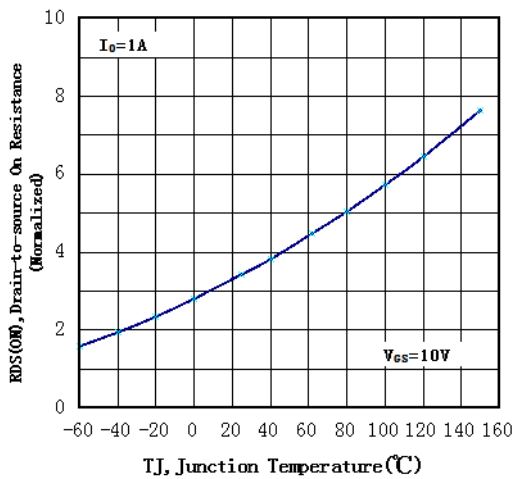

Fig3 Normalized Resistance Vs. Temperature

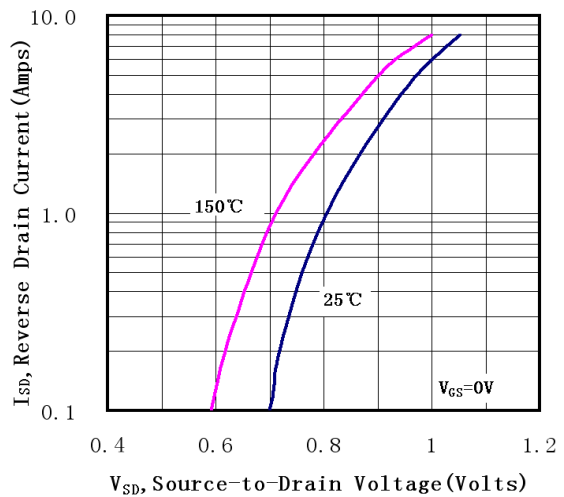

Fig4 Typical Source-Drain Diode Forward Voltage

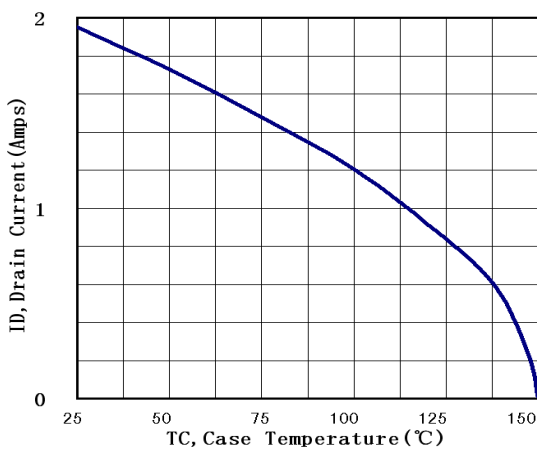

Fig5 Maximum Drain Current Vs. Case Temperature

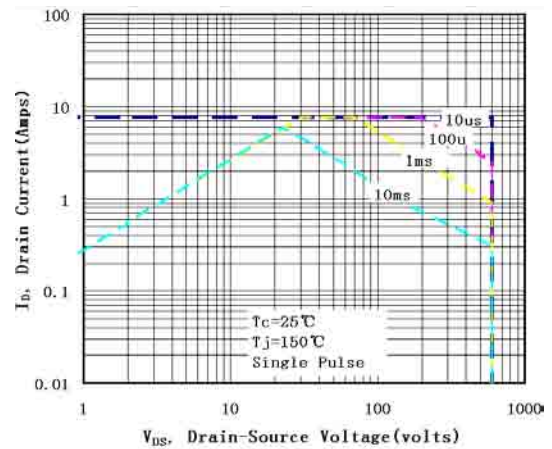
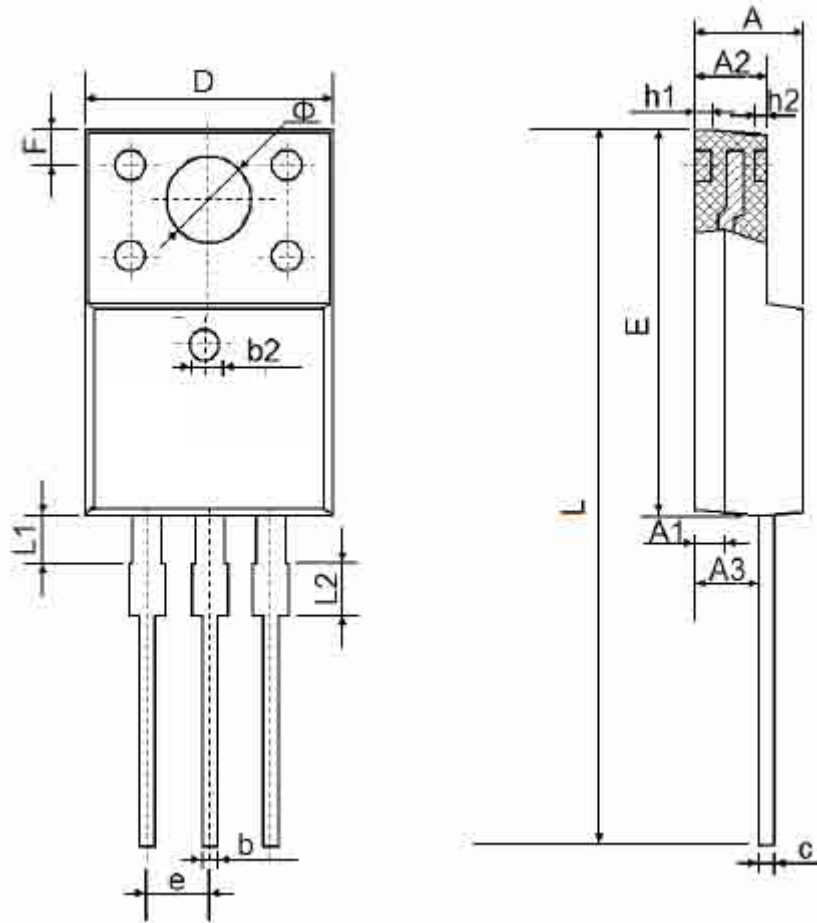

Fig6 Maximum Safe Operating Area

TO-220F-3L Package Information



Symbol	Dimensions In Millimeters		Dimensions In Inches	
	Min.	Max.	Min.	Max.
A	4.300	4.700	0.169	0.185
A1	1.300REF		0.051REF	
A2	2.800	3.200	0.110	0.126
A3	2.500	2.900	0.098	0.114
b	0.500	0.750	0.020	0.030
b1	1.100	1.350	0.043	0.053
b2	1.500	1.750	0.059	0.069
c	0.500	0.750	0.020	0.030
D	9.960	10.360	0.392	0.408
E	14.800	15.200	0.583	0.598
e	2.540TYP.		0.100TYP	
F	2.700REF		0.106REF	
Φ	3.500REF		0.138REF	
h1	0.800REF		0.031REF	
h2	0.500REF		0.020REF	
L	28.000	28.400	1.102	1.118
L1	1.700	1.900	0.067	0.075
L2	1.900	2.100	0.075	0.083