

Features

- Thin small outline package (TSOP) I package configurable as 512 K × 16 or 1 M × 8 static RAM (SRAM)
- High speed: 45 ns
- Temperature ranges
 - Industrial: -40 °C to +85 °C
 - Automotive-A: -40 °C to +85 °C
 - Automotive-E: -40 °C to +125 °C
- Wide voltage range: 2.20 V to 3.60 V
- Pin compatible with CY62157DV30
- Ultra low standby power
 - Typical standby current: 2 μA
 - Maximum standby current: 8 μA (Industrial)
- Ultra low active power
 - Typical active current: 1.8 mA at f = 1 MHz
- Easy memory expansion with \overline{CE}_1 , CE_2 , and \overline{OE} features
- Automatic power down when deselected
- Complementary Metal Oxide Semiconductor (CMOS) for optimum speed and power
- Available in Pb-free and non Pb-free 48-ball very fine-pitch ball grid array (VFBGA), Pb-free 44-pin TSOP II and 48-pin TSOP I packages

Functional Description

The CY62157EV30 is a high performance CMOS static RAM organized as 512K words by 16 bits. This device features advanced circuit design to provide ultra low active current. This is ideal for providing More Battery Life™ (MoBL®) in portable applications such as cellular telephones. The device also has an automatic power down feature that significantly reduces power consumption when addresses are not toggling. Place the device into standby mode when deselected (\overline{CE}_1 HIGH or CE_2 LOW or both \overline{BHE} and \overline{BLE} are HIGH). The input or output pins (I/O₀ through I/O₁₅) are placed in a high impedance state when the device is deselected (\overline{CE}_1 HIGH or CE_2 LOW), the outputs are disabled (\overline{OE} HIGH), Byte High Enable and Byte Low Enable are disabled (\overline{BHE} , \overline{BLE} HIGH), or a write operation is active (CE_1 LOW, CE_2 HIGH and WE LOW).

To write to the device, take Chip Enable (\overline{CE}_1 LOW and CE_2 HIGH) and Write Enable (WE) inputs LOW. If Byte Low Enable (\overline{BLE}) is LOW, then data from I/O pins (I/O₀ through I/O₇) is written into the location specified on the address pins (A₀ through A₁₈). If Byte High Enable (\overline{BHE}) is LOW, then data from I/O pins (I/O₈ through I/O₁₅) is written into the location specified on the address pins (A₀ through A₁₈).

To read from the device, take Chip Enable (\overline{CE}_1 LOW and CE_2 HIGH) and Output Enable (\overline{OE}) LOW while forcing the Write Enable (WE) HIGH. If Byte Low Enable (\overline{BLE}) is LOW, then data from the memory location specified by the address pins appear on I/O₀ to I/O₇. If Byte High Enable (\overline{BHE}) is LOW, then data from memory appears on I/O₈ to I/O₁₅. See Truth Table on page 13 for a complete description of read and write modes.

Logic Block Diagram

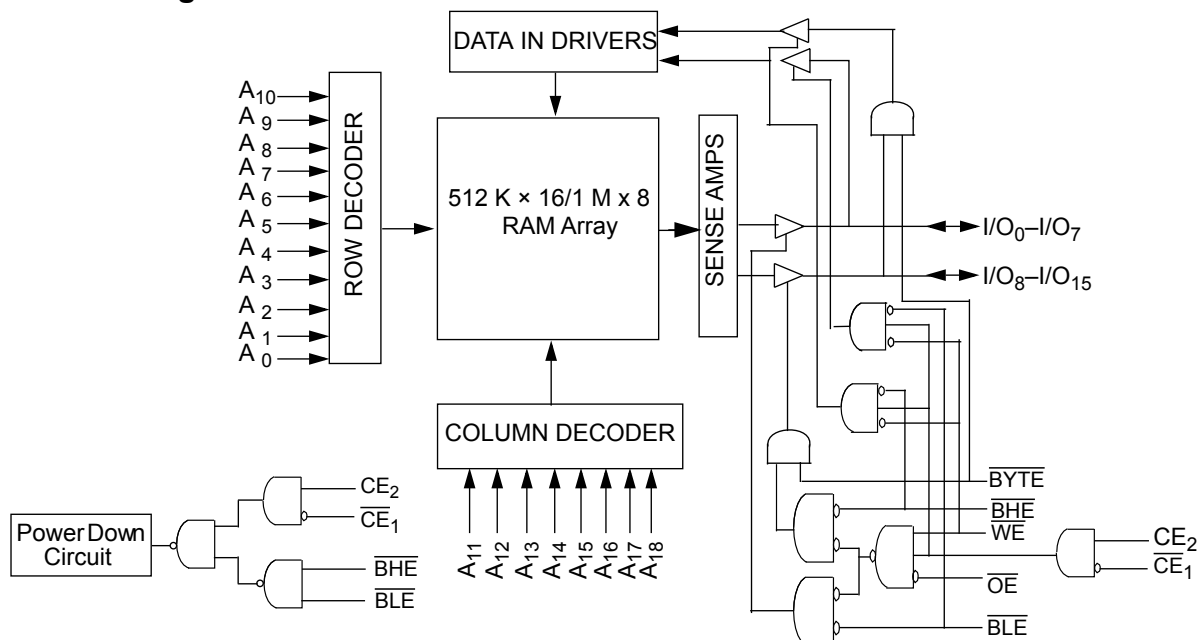

Contents

Pin Configurations	3	Ordering Information	14
Product Portfolio	3	Ordering Code Definitions	14
Maximum Ratings	4	Package Diagrams	15
Operating Range	4	Acronyms	18
Electrical Characteristics	4	Document Conventions	18
Capacitance	5	Units of Measure	18
Thermal Resistance	5	Document History Page	19
AC Test Loads and Waveforms	5	Sales, Solutions, and Legal Information	21
Data Retention Characteristics	6	Worldwide Sales and Design Support	21
Data Retention Waveform	6	Products	21
Switching Characteristics	7	PSoC [®] Solutions	21
Switching Waveforms	8	Cypress Developer Community	21
Truth Table	13	Technical Support	21

Pin Configurations

Figure 1. 48-ball VFBGA pinout (Top View) [1]

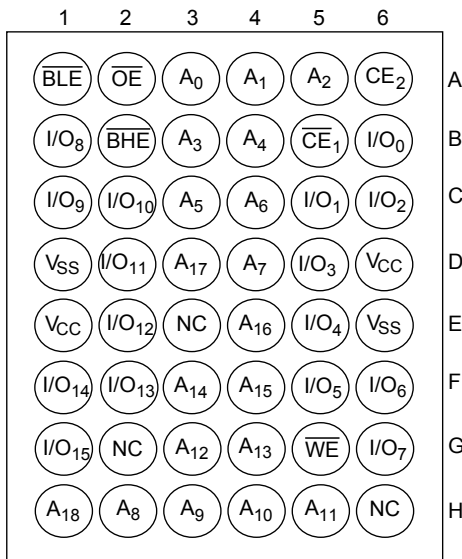

Figure 2. 44-pin TSOP II pinout (Top View) [2]

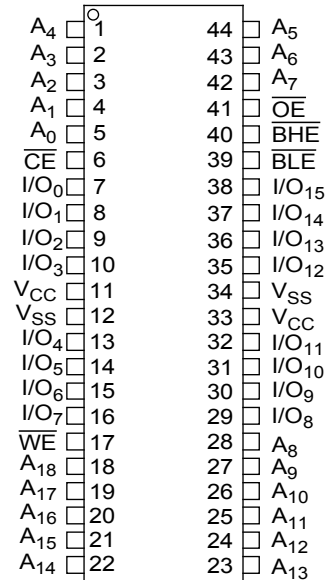
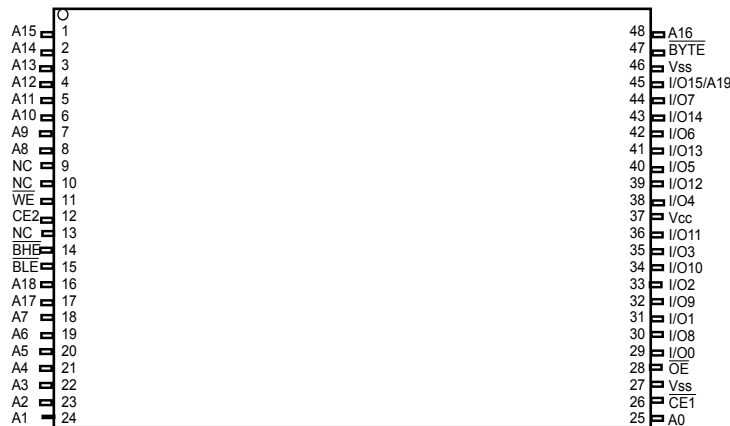

Figure 3. 48-pin TSOP I pinout (Top View) [1, 3]



Product Portfolio

Product	Range	V _{CC} Range (V)			Speed (ns)	Power Dissipation					
						Operating I _{CC} (mA)				Standby, I _{SB2} (μA)	
		Min	Typ [4]	Max		f = 1 MHz		f = f _{max}			
					Typ [4]	Max	Typ [4]	Max	Typ [4]	Max	
CY62157EV30LL	Industrial/Auto-A	2.2	3.0	3.6	45	1.8	3	18	25	2	8
	Auto-E	2.2	3.0	3.6	55	1.8	4	18	35	2	30

Notes

- NC pins are not connected on the die.
- The 44-pin TSOP II package has only one chip enable (CE) pin.
- The BYTE pin in the 48-pin TSOP I package must be tied HIGH to use the device as a 512 K × 16 SRAM. The 48-pin TSOP I package can also be used as a 1 M × 8 SRAM by tying the BYTE signal LOW. In the 1 M × 8 configuration, Pin 45 is A19, while BHE, BLE and I/O₈ to I/O₁₄ pins are not used (NC).
- Typical values are included for reference only and are not guaranteed or tested. Typical values are measured at V_{CC} = V_{CC(typ)}, T_A = 25 °C.

Maximum Ratings

Exceeding the maximum ratings may impair the useful life of the device. User guidelines are not tested.

Storage Temperature	-65 °C to + 150 °C
Ambient Temperature with Power Applied	-55 °C to + 125 °C
Supply Voltage to Ground Potential	-0.3 V to 3.9 V ($V_{CCmax} + 0.3$ V)
DC Voltage Applied to Outputs in High Z State ^[5, 6]	-0.3 V to 3.9 V ($V_{CCmax} + 0.3$ V)
DC Input Voltage ^[5, 6]	-0.3 V to 3.9 V ($V_{CCmax} + 0.3$ V)

Output Current into Outputs (LOW)	20 mA
Static Discharge Voltage (MIL-STD-883, Method 3015)	> 2001 V
Latch Up Current	> 200 mA

Operating Range

Device	Range	Ambient Temperature	V_{CC} ^[7]
CY62157EV30LL	Industrial/Automotive-A	-40 °C to +85 °C	2.2 V to 3.6 V
	Automotive-E	-40 °C to +125 °C	

Electrical Characteristics

Over the Operating Range

Parameter	Description	Test Conditions	45 ns (Industrial/Automotive-A)			55 ns (Automotive-E)			Unit
			Min	Typ ^[8]	Max	Min	Typ ^[8]	Max	
V_{OH}	Output HIGH voltage	$I_{OH} = -0.1$ mA	2.0	-	-	2.0	-	-	V
		$I_{OH} = -1.0$ mA, $V_{CC} \geq 2.70$ V	2.4	-	-	2.4	-	-	V
V_{OL}	Output LOW voltage	$I_{OL} = 0.1$ mA	-	-	0.4	-	-	0.4	V
		$I_{OL} = 2.1$ mA, $V_{CC} \geq 2.70$ V	-	-	0.4	-	-	0.4	V
V_{IH}	Input HIGH voltage	$V_{CC} = 2.2$ V to 2.7 V	1.8	-	$V_{CC} + 0.3$	1.8	-	$V_{CC} + 0.3$	V
		$V_{CC} = 2.7$ V to 3.6 V	2.2	-	$V_{CC} + 0.3$	2.2	-	$V_{CC} + 0.3$	V
V_{IL}	Input LOW voltage	$V_{CC} = 2.2$ V to 2.7 V	-0.3	-	0.6	-0.3	-	0.6	V
		$V_{CC} = 2.7$ V to 3.6 V	-0.3	-	0.8	-0.3	-	0.8	V
I_{IX}	Input leakage current	$GND \leq V_I \leq V_{CC}$	-1	-	+1	-4	-	+4	μ A
I_{OZ}	Output leakage current	$GND \leq V_O \leq V_{CC}$, Output Disabled	-1	-	+1	-4	-	+4	μ A
I_{CC}	V_{CC} operating supply current	$f = f_{max} = 1/t_{RC}$ $V_{CC} = V_{CCmax}$	-	18	25	-	18	35	mA
		$f = 1$ MHz CMOS levels	-	1.8	3	-	1.8	4	
I_{SB1} ^[9]	Automatic CE power down current — CMOS inputs	$\overline{CE}_1 \geq V_{CC} - 0.2$ V or $CE_2 \leq 0.2$ V or (BHE and BLE) $\geq V_{CC} - 0.2$ V, $V_{IN} \geq V_{CC} - 0.2$ V, $V_{IN} \leq 0.2$ V, $f = f_{max}$ (Address and Data Only), $f = 0$ (OE and WE), $V_{CC} = 3.60$ V	-	2	8	-	2	30	μ A
I_{SB2} ^[9]	Automatic CE power down current — CMOS inputs	$\overline{CE}_1 \geq V_{CC} - 0.2$ V or $CE_2 \leq 0.2$ V or (BHE and BLE) $\geq V_{CC} - 0.2$ V, $V_{IN} \geq V_{CC} - 0.2$ V or $V_{IN} \leq 0.2$ V, $f = 0$, $V_{CC} = 3.60$ V	-	2	8	-	2	30	μ A

Notes

- $V_{IL(min)}$ = -2.0 V for pulse durations less than 20 ns.
- $V_{IH(max)}$ = $V_{CC} + 0.75$ V for pulse durations less than 20 ns.
- Full device AC operation assumes a 100 μ s ramp time from 0 to $V_{CC(min)}$ and 200 μ s wait time after V_{CC} stabilization.
- Typical values are included for reference only and are not guaranteed or tested. Typical values are measured at $V_{CC} = V_{CC(typ)}$, $T_A = 25$ °C.
- Chip enables (CE_1 and CE_2), byte enables (BHE and BLE) and BYTE (48-pin TSOP I only) need to be tied to CMOS levels to meet the $I_{SB1} / I_{SB2} / I_{CCDR}$ spec. Other inputs can be left floating.

Capacitance

Parameter ^[10]	Description	Test Conditions	Max	Unit
C _{IN}	Input capacitance	T _A = 25 °C, f = 1 MHz, V _{CC} = V _{CC(typ)}	10	pF
C _{OUT}	Output capacitance		10	pF

Thermal Resistance

Parameter ^[10]	Description	Test Conditions	48-ball BGA	44-pin TSOP I	44-pin TSOP II	Unit
Θ _{JA}	Thermal resistance (junction to Ambient)	Still air, soldered on a 3 × 4.5 inch, two-layer printed circuit board	72	74.88	76.88	°C/W
Θ _{JC}	Thermal resistance (junction to Case)		8.86	8.6	13.52	°C/W

AC Test Loads and Waveforms

Figure 4. AC Test Loads and Waveforms

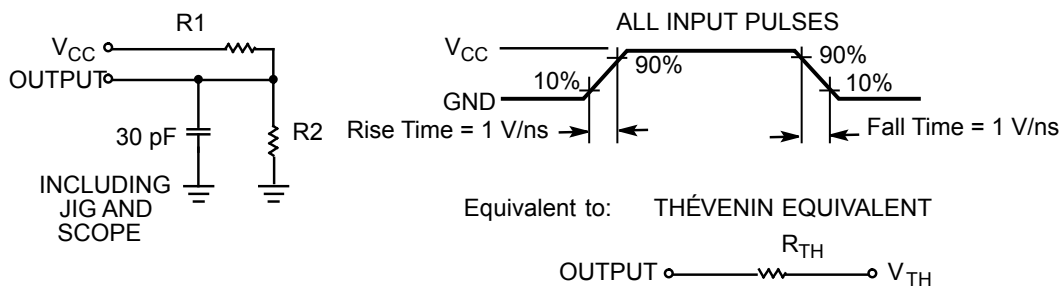

Parameters	2.5 V	3.0 V	Unit
R1	16667	1103	Ω
R2	15385	1554	Ω
R _{TH}	8000	645	Ω
V _{TH}	1.20	1.75	V

Note

10. Tested initially and after any design or process changes that may affect these parameters.

Data Retention Characteristics

Over the Operating Range

Parameter	Description	Conditions	Min	Typ ^[11]	Max	Unit
V_{DR}	V_{CC} for data retention		1.5	–	–	V
I_{CCDR} ^[12]	Data retention current	$V_{CC} = 1.5\text{ V}$, $\overline{CE}_1 \geq V_{CC} - 0.2\text{ V}$, $CE_2 \leq 0.2\text{ V}$, $(\overline{BHE}\text{ and } \overline{BLE}) \geq V_{CC} - 0.2\text{ V}$, $V_{IN} \geq V_{CC} - 0.2\text{ V}$ or $V_{IN} \leq 0.2\text{ V}$				
		Industrial/Auto-A	–	2	5	μA
		Auto-E	–	–	30	
t_{CDR} ^[13]	Chip deselect to data retention time		0	–		ns
t_R ^[14]	Operation recovery time					
		CY62157EV30LL-45	45	–	–	ns
		CY62157EV30LL-55	55	–	–	

Data Retention Waveform

Figure 5. Data Retention Waveform^[15]

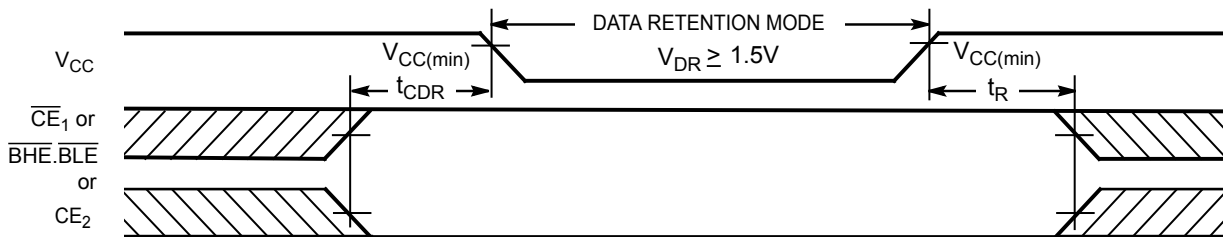

Notes

11. Typical values are included for reference only and are not guaranteed or tested. Typical values are measured at $V_{CC} = V_{CC(\text{typ})}$, $T_A = 25^\circ\text{C}$.
12. Chip enables (\overline{CE}_1 and CE_2), byte enables (\overline{BHE} and \overline{BLE}) and BYTE (48-pin TSOP I only) need to be tied to CMOS levels to meet the I_{SB1} / I_{SB2} / I_{CCDR} spec. Other inputs can be left floating.
13. Tested initially and after any design or process changes that may affect these parameters.
14. Full device operation requires linear V_{CC} ramp from V_{DR} to $V_{CC(\text{min})} \geq 100\ \mu\text{s}$ or stable at $V_{CC(\text{min})} \geq 100\ \mu\text{s}$.
15. $\overline{BHE.BLE}$ is the AND of both \overline{BHE} and \overline{BLE} . Deselect the chip by either disabling chip enable signals or by disabling both \overline{BHE} and \overline{BLE} .

Switching Characteristics

Over the Operating Range

Parameter ^[16, 17]	Description	45 ns (Industrial/Auto-A)		55 ns (Auto-E)		Unit
		Min	Max	Min	Max	
Read Cycle						
t_{RC}	Read cycle time	45	–	55	–	ns
t_{AA}	Address to data valid	–	45	–	55	ns
t_{OHA}	Data hold from address change	10	–	10	–	ns
t_{ACE}	\overline{CE}_1 LOW and CE_2 HIGH to data valid	–	45	–	55	ns
t_{DOE}	\overline{OE} LOW to data valid	–	22	–	25	ns
t_{LZOE}	\overline{OE} LOW to Low Z ^[18]	5	–	5	–	ns
t_{HZOE}	\overline{OE} HIGH to High Z ^[18, 19]	–	18	–	20	ns
t_{LZCE}	\overline{CE}_1 LOW and CE_2 HIGH to Low Z ^[18]	10	–	10	–	ns
t_{HZCE}	\overline{CE}_1 HIGH and CE_2 LOW to High Z ^[18, 19]	–	18	–	20	ns
t_{PU}	\overline{CE}_1 LOW and CE_2 HIGH to power up	0	–	0	–	ns
t_{PD}	\overline{CE}_1 HIGH and CE_2 LOW to power down	–	45	–	55	ns
t_{DBE}	$\overline{BLE}/\overline{BHE}$ LOW to data valid	–	45	–	55	ns
t_{LZBE}	$\overline{BLE}/\overline{BHE}$ LOW to Low Z ^[18, 20]	5	–	10	–	ns
t_{HZBE}	$\overline{BLE}/\overline{BHE}$ HIGH to High Z ^[18, 19]	–	18	–	20	ns
Write Cycle^[21]						
t_{WC}	Write cycle time	45	–	55	–	ns
t_{SCE}	\overline{CE}_1 LOW and CE_2 HIGH to write end	35	–	40	–	ns
t_{AW}	Address setup to write end	35	–	40	–	ns
t_{HA}	Address hold from write end	0	–	0	–	ns
t_{SA}	Address setup to write start	0	–	0	–	ns
t_{PWE}	\overline{WE} pulse width	35	–	40	–	ns
t_{BW}	$\overline{BLE}/\overline{BHE}$ LOW to write end	35	–	40	–	ns
t_{SD}	Data setup to write end	25	–	25	–	ns
t_{HD}	Data hold from write end	0	–	0	–	ns
t_{HZWE}	\overline{WE} LOW to High Z ^[18, 19]	–	18	–	20	ns
t_{LZWE}	\overline{WE} HIGH to Low Z ^[18]	10	–	10	–	ns

Notes

16. Test conditions for all parameters other than tri-state parameters assume signal transition time of 3 ns or less, timing reference levels of $V_{CC(typ)}/2$, input pulse levels of 0 to $V_{CC(typ)}$, and output loading of the specified I_{OL}/I_{OH} as shown in the Figure 4 on page 5.
17. In an earlier revision of this device, under a specific application condition, READ and WRITE operations were limited to switching of the byte enable and/or chip enable signals as described in the Application Notes AN13842 and AN66311. However, the issue has been fixed and in production now, and hence, these Application Notes are no longer applicable. They are available for download on our website as they contain information on the date code of the parts, beyond which the fix has been in production.
18. At any temperature and voltage condition, t_{HZCE} is less than t_{LZCE} , t_{HZBE} is less than t_{LZBE} , t_{HZOE} is less than t_{LZOE} , and t_{HZWE} is less than t_{LZWE} for any device.
19. t_{HZOE} , t_{HZCE} , t_{HZBE} , and t_{HZWE} transitions are measured when the outputs enter a high-impedance state.
20. If both byte enables are toggled together, this value is 10 ns.
21. The internal write time of the memory is defined by the overlap of \overline{WE} , $\overline{CE} = V_{IL}$, \overline{BHE} , \overline{BLE} or both = V_{IL} , and $CE_2 = V_{IH}$. All signals must be active to initiate a write and any of these signals can terminate a write by going inactive. The data input setup and hold timing must be referenced to the edge of the signal that terminates the write.

Switching Waveforms

Figure 6. Read Cycle No. 1 (Address Transition Controlled) [22, 23]

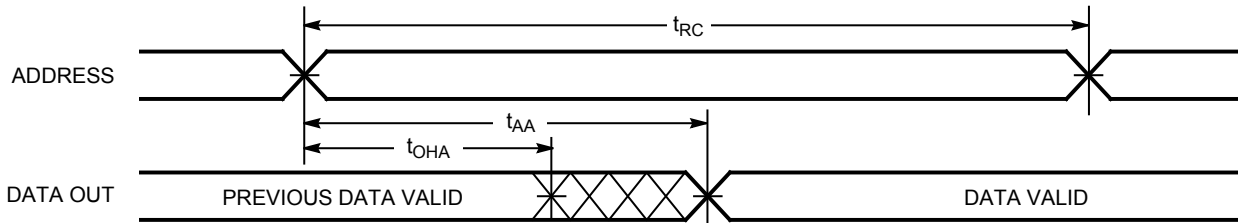
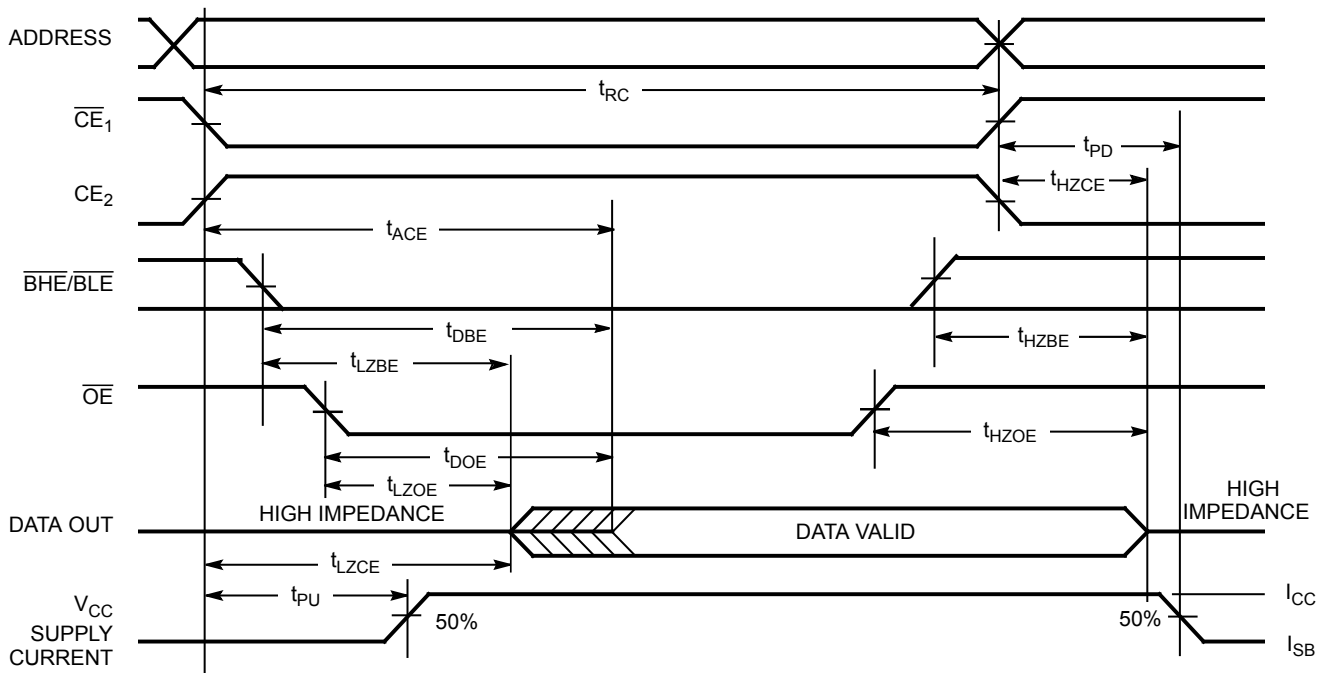

Figure 7. Read Cycle No. 2 (\overline{OE} Controlled) [23, 24]



Notes

- 22. The device is continuously selected. \overline{OE} , $\overline{CE}_1 = V_{IL}$, \overline{BHE} , \overline{BLE} , or both = V_{IL} , and $CE_2 = V_{IH}$.
- 23. WE is HIGH for read cycle.
- 24. Address valid before or similar to \overline{CE}_1 , \overline{BHE} , \overline{BLE} transition LOW and CE_2 transition HIGH.

Switching Waveforms (continued)

Figure 8. Write Cycle No. 1 (\overline{WE} Controlled) [25, 26, 27]

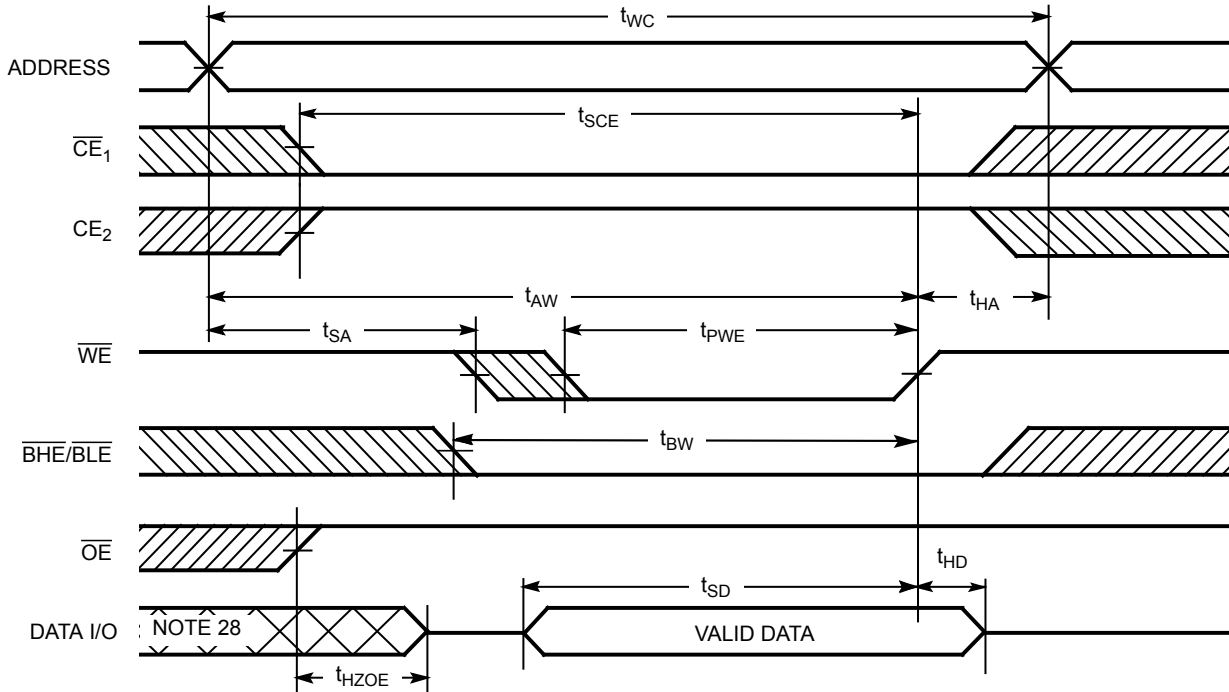

Notes

25. The internal write time of the memory is defined by the overlap of \overline{WE} , $\overline{CE} = V_{IL}$, \overline{BHE} , \overline{BLE} or both = V_{IL} , and $CE_2 = V_{IH}$. All signals must be active to initiate a write and any of these signals can terminate a write by going inactive. The data input setup and hold timing must be referenced to the edge of the signal that terminates the write.

26. Data I/O is high impedance if $\overline{OE} = V_{IH}$.

27. If \overline{CE}_1 goes HIGH and CE_2 goes LOW simultaneously with $\overline{WE} = V_{IH}$, the output remains in a high impedance state.

28. During this period, the I/Os are in output state. Do not apply input signals.

Switching Waveforms (continued)

Figure 9. Write Cycle No. 2 (\overline{CE}_1 or CE_2 Controlled) [29, 30, 31]

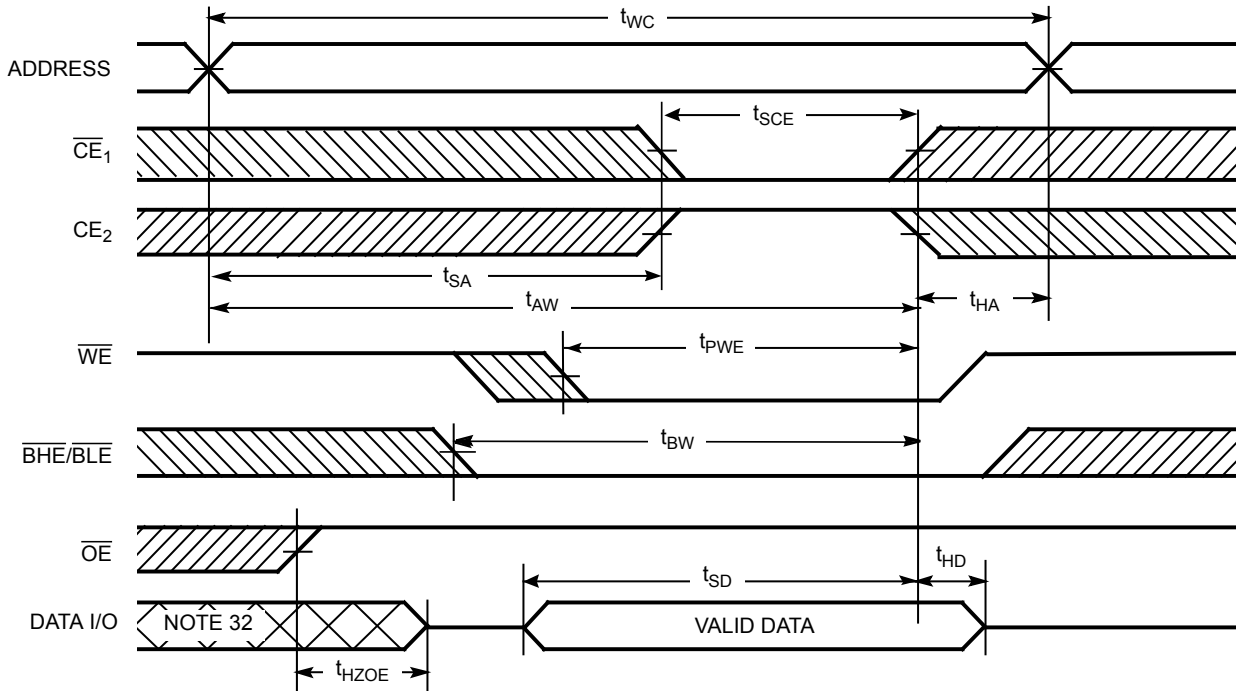

Notes

29. The internal write time of the memory is defined by the overlap of \overline{WE} , $\overline{CE} = V_{IL}$, \overline{BHE} , \overline{BLE} or both = V_{IL} , and $CE_2 = V_{IH}$. All signals must be active to initiate a write and any of these signals can terminate a write by going inactive. The data input setup and hold timing must be referenced to the edge of the signal that terminates the write.

30. Data I/O is high impedance if $\overline{OE} = V_{IH}$.

31. If \overline{CE}_1 goes HIGH and CE_2 goes LOW simultaneously with $\overline{WE} = V_{IH}$, the output remains in a high impedance state.

32. During this period, the I/Os are in output state. Do not apply input signals.

Switching Waveforms (continued)

Figure 10. Write Cycle No. 3 (\overline{WE} Controlled, \overline{OE} LOW) [33]

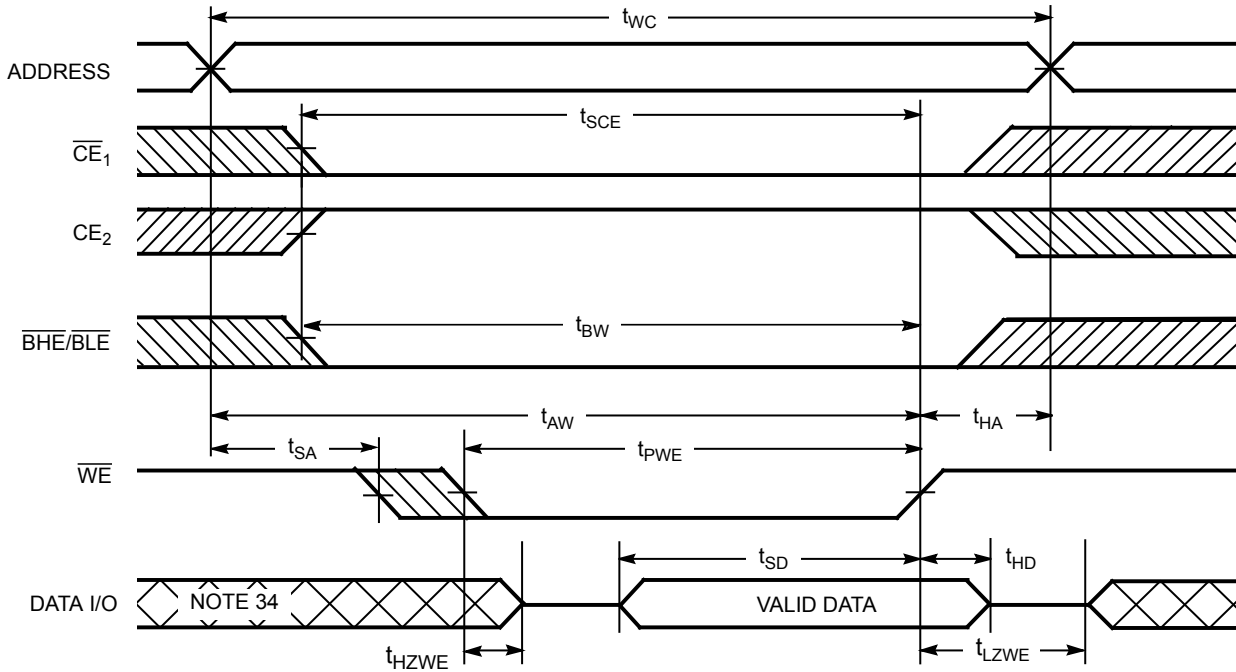

Notes

- 33. If \overline{CE}_1 goes HIGH and CE_2 goes LOW simultaneously with $\overline{WE} = V_{IH}$, the output remains in a high impedance state.
- 34. During this period, the I/Os are in output state. Do not apply input signals.

Switching Waveforms (continued)

Figure 11. Write Cycle No. 4 ($\overline{\text{BHE}}/\overline{\text{BLE}}$ Controlled, $\overline{\text{OE}}$ LOW)^[35]

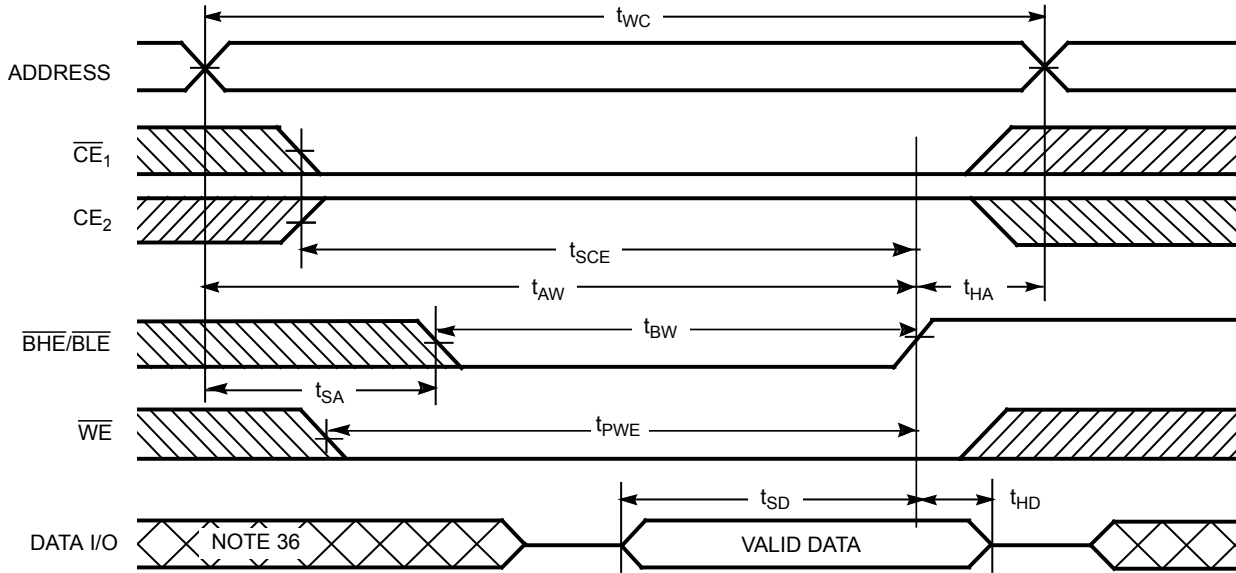

Notes

- 35. If $\overline{\text{CE}}_1$ goes HIGH and CE_2 goes LOW simultaneously with $\overline{\text{WE}} = V_{IH}$, the output remains in a high impedance state.
- 36. During this period, the I/Os are in output state. Do not apply input signals.

Truth Table

\overline{CE}_1	CE_2	\overline{WE}	\overline{OE}	\overline{BHE}	\overline{BLE}	Inputs/Outputs	Mode	Power
H	X ^[37]	X	X	X	X	High Z	Deselect/power down	Standby (I_{SB})
X ^[37]	L	X	X	X	X	High Z	Deselect/power down	Standby (I_{SB})
X ^[37]	X ^[37]	X	X	H	H	High Z	Deselect/power down	Standby (I_{SB})
L	H	H	L	L	L	Data Out (I/O_0 – I/O_{15})	Read	Active (I_{CC})
L	H	H	L	H	L	Data Out (I/O_0 – I/O_7); High Z (I/O_8 – I/O_{15})	Read	Active (I_{CC})
L	H	H	L	L	H	High Z (I/O_0 – I/O_7); Data Out (I/O_8 – I/O_{15})	Read	Active (I_{CC})
L	H	H	H	L	H	High Z	Output disabled	Active (I_{CC})
L	H	H	H	H	L	High Z	Output disabled	Active (I_{CC})
L	H	H	H	L	L	High Z	Output disabled	Active (I_{CC})
L	H	L	X	L	L	Data In (I/O_0 – I/O_{15})	Write	Active (I_{CC})
L	H	L	X	H	L	Data In (I/O_0 – I/O_7); High Z (I/O_8 – I/O_{15})	Write	Active (I_{CC})
L	H	L	X	L	H	High Z (I/O_0 – I/O_7); Data In (I/O_8 – I/O_{15})	Write	Active (I_{CC})

Note

37. The 'X' (Don't care) state for the Chip enables in the truth table refer to the logic state (either HIGH or LOW). Intermediate voltage levels on these pins is not permitted.

Ordering Information

Speed (ns)	Ordering Code	Package Diagram	Package Type	Operating Range
45	CY62157EV30LL-45BVI	51-85150	48-ball VFBGA	Industrial
	CY62157EV30LL-45BVXI	51-85150	48-ball VFBGA (Pb-free)	
	CY62157EV30LL-45ZSXI	51-85087	44-pin TSOP Type II (Pb-free)	
	CY62157EV30LL-45ZXI	51-85183	48-pin TSOP Type I (Pb-free)	
	CY62157EV30LL-45BVXA	51-85150	48-ball VFBGA (Pb-free)	Automotive-A
	CY62157EV30LL-45ZSXA	51-85087	44-pin TSOP Type II (Pb-free)	
	CY62157EV30LL-45ZXXA	51-85183	48-pin TSOP Type I (Pb-free)	
55	CY62157EV30LL-55ZSXE	51-85087	44-pin TSOP Type II (Pb-free)	Automotive-E
	CY62157EV30LL-55ZXXE	51-85183	48-pin TSOP Type I (Pb-free)	

Contact your local Cypress sales representative for availability of these parts.

Ordering Code Definitions

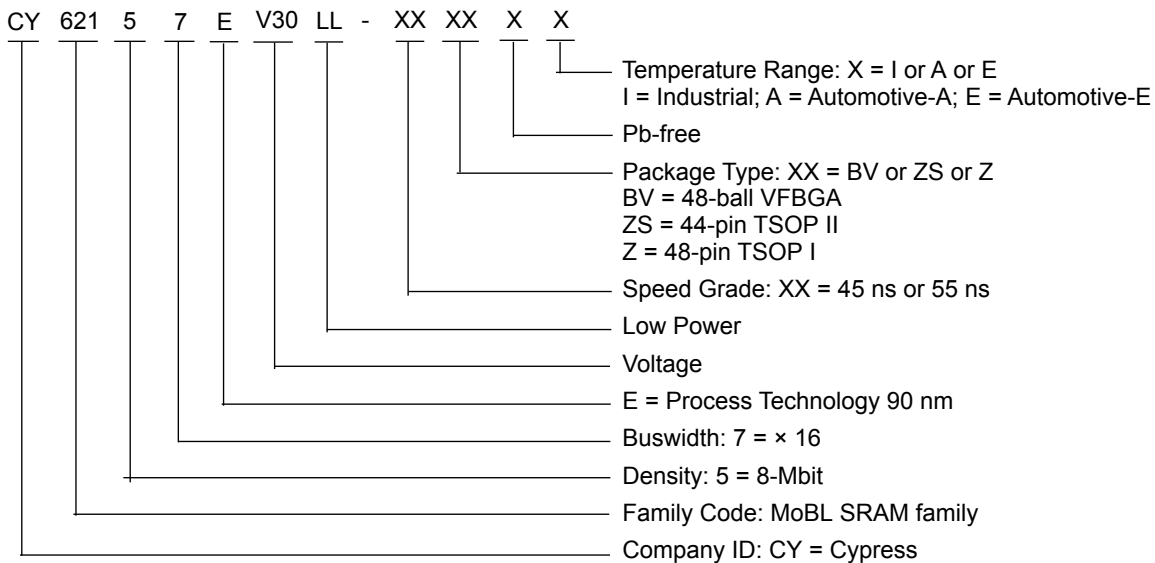

Package Diagrams

Figure 12. 48-pin VFBGA (6 × 8 × 1 mm) BV48/BZ48 Package Outline, 51-85150

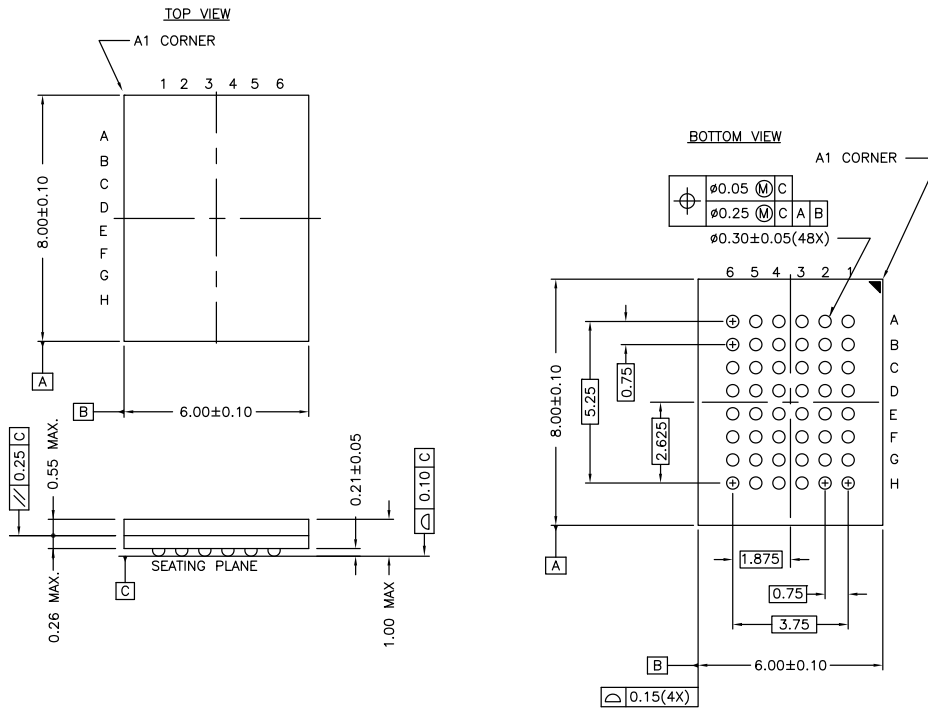

NOTE:
 PACKAGE WEIGHT: See Cypress Package Material Declaration Datasheet (PMDD)
 posted on the Cypress web.

51-85150 *H

Package Diagrams (continued)

Figure 13. 44-pin TSOP Z44-II Package Outline, 51-85087

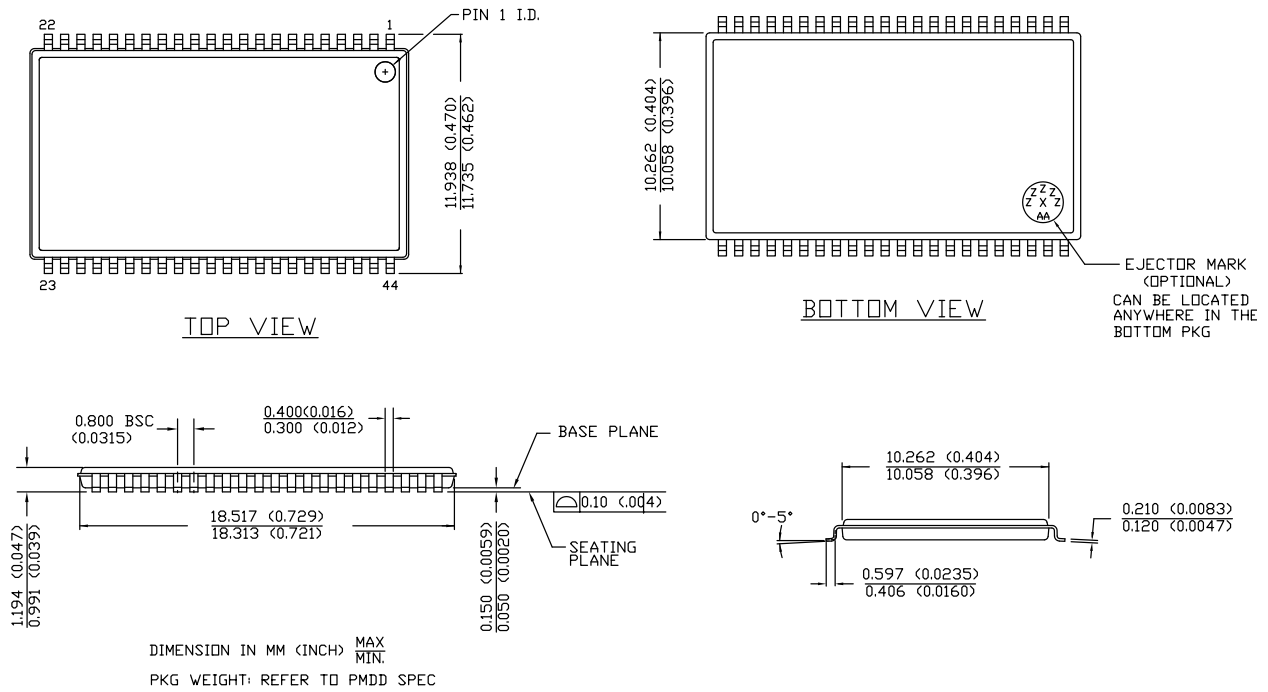

51-85087 *E

Package Diagrams (continued)

Figure 14. 48-pin TSOP I (12 × 18.4 × 1.0 mm) Z48A Package Outline, 51-85183

DIMENSIONS IN INCHES[MM] MIN. MAX.

JEDEC # MO-142

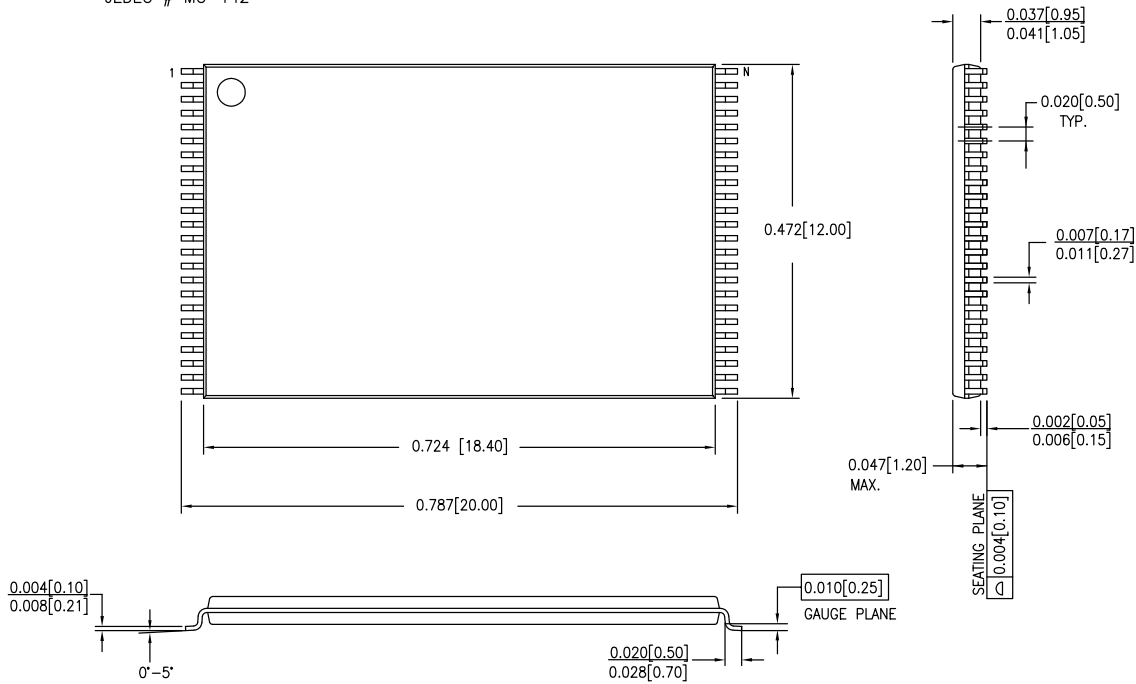

51-85183 *C

Acronyms

Acronym	Description
\overline{CE}	Chip Enable
CMOS	Complementary Metal Oxide Semiconductor
I/O	Input/Output
\overline{OE}	Output Enable
RAM	Random Access Memory
SRAM	Static Random Access Memory
TSOP	Thin Small Outline Package
VFBGA	Very Fine-Pitch Ball Grid Array
\overline{WE}	Write Enable

Document Conventions

Units of Measure

Symbol	Unit of Measure
°C	degree Celsius
MHz	megahertz
μA	microampere
μs	microsecond
mA	milliampere
mm	millimeter
ns	nanosecond
Ω	ohm
%	percent
pF	picofarad
V	volt
W	watt

Document History Page

Document Title: CY62157EV30 MoBL [®] , 8-Mbit (512 K × 16) Static RAM Document Number: 38-05445				
Revision	ECN	Orig. of Change	Submission Date	Description of Change
**	202940	AJU	See ECN	New data sheet.
*A	291272	SYT	See ECN	Converted from Advance Information to Preliminary Removed 48-TSOP I Package and the associated footnote Added footnote stating 44 TSOP II Package has only one \overline{CE} on Page # 2 Changed V_{CC} stabilization time in footnote #7 from 100 μ s to 200 μ s Changed I_{CCDR} from 4 to 4.5 μ A Changed t_{OHA} from 6 to 10 ns for both 35 and 45 ns Speed Bins Changed t_{DOE} from 15 to 18 ns for 35 ns Speed Bin Changed t_{HZOE} , t_{HZBE} and t_{HZWE} from 12 and 15 ns to 15 and 18 ns for 35 and 45 ns Speed Bins respectively Changed t_{HZCE} from 12 and 15 ns to 18 and 22 ns for 35 and 45 ns Speed Bins respectively Changed t_{SCE} , t_{AW} and t_{BW} from 25 and 40 ns to 30 and 35 ns for 35 and 45 ns Speed Bins respectively Changed t_{SD} from 15 and 20 ns to 18 and 22 ns for 35 and 45 ns Speed Bins respectively Added Lead-Free Package Information
*B	444306	NXR	See ECN	Converted from Preliminary to Final. Changed ball E3 from DNU to NC Removed redundant footnote on DNU. Removed 35 ns speed bin Removed "L" bin Added 48 pin TSOP I package Added Automotive product information. Changed the I_{CC} Typ value from 16 mA to 18 mA and I_{CC} Max value from 28 mA to 25 mA for test condition f = fax = 1/ t_{RC} . Changed the I_{CC} Max value from 2.3 mA to 3 mA for test condition f = 1MHz. Changed the I_{SB1} and I_{SB2} Max value from 4.5 μ A to 8 μ A and Typ value from 0.9 μ A to 2 μ A respectively. Modified ISB_1 test condition to include \overline{BHE} , \overline{BLE} Updated Thermal Resistance table. Changed Test Load Capacitance from 50 pF to 30 pF. Added Typ value for I_{CCDR} . Changed the I_{CCDR} Max value from 4.5 μ A to 5 μ A Corrected t_R in Data Retention Characteristics from 100 μ s to t_{RC} ns. Changed t_{LZOE} from 3 to 5 Changed t_{LZCE} from 6 to 10 Changed t_{HZCE} from 22 to 18 Changed t_{LZBE} from 6 to 5 Changed t_{PWE} from 30 to 35 Changed t_{SD} from 22 to 25 Changed t_{LZWE} from 6 to 10 Added footnote #15 Updated the ordering Information and replaced the Package Name column with Package Diagram.
*C	467052	NXR	See ECN	Modified Data sheet to include x8 configurability. Updated the Ordering Information table
*D	925501	VKN	See ECN	Removed Automotive-E information Added Preliminary Automotive-A information Added footnote #10 related to I_{SB2} and I_{CCDR} Added footnote #15 related AC timing parameters

Document History Page (continued)

Document Title: CY62157EV30 MoBL®, 8-Mbit (512 K × 16) Static RAM Document Number: 38-05445				
Revision	ECN	Orig. of Change	Submission Date	Description of Change
*E	1045801	VKN	See ECN	Converted Automotive-A specs from preliminary to final Updated footnote #9
*F	2724889	NXR / AESA	06/26/09	Added Automotive-E information Included -45ZXA/-55ZSXE/-55ZXE parts in the Ordering Information table
*G	2927528	VKN	05/04/2010	Renamed “DNU” pins as “NC” for 48 TSOP I package Added footnote #24 related to chip enable Updated Package Diagrams Added Contents Updated links in Sales, Solutions, and Legal Information
*H	3110053	PRAS	12/14/2010	Changed Table Footnotes to Footnotes. Added Ordering Code Definitions.
*I	3269771	RAME	05/30/2011	Updated Functional Description (Removed “For best practice recommendations, refer to the Cypress application note AN1064, SRAM System Guidelines.”). Updated Electrical Characteristics . Updated Data Retention Characteristics . Updated Package Diagrams . Added Acronyms and Units of Measure . Updated in new template.
*J	3578601	TAVA	04/11/2012	Updated Package Diagrams .
*K	4102449	VINI	08/22/2013	Updated Switching Characteristics : Updated Note 17. Updated Package Diagrams : spec 51-85150 – Changed revision from *G to *H. spec 51-85087 – Changed revision from *D to *E. Updated in new template.
*L	4126231	VINI	09/18/2013	Updated Switching Characteristics : Updated Note 17 (Removed last sentence from Note 17 and added the same sentence as a new note namely Note 18).

Sales, Solutions, and Legal Information

Worldwide Sales and Design Support

Cypress maintains a worldwide network of offices, solution centers, manufacturer's representatives, and distributors. To find the office closest to you, visit us at [Cypress Locations](#).

Products

Automotive	cypress.com/go/automotive
Clocks & Buffers	cypress.com/go/clocks
Interface	cypress.com/go/interface
Lighting & Power Control	cypress.com/go/powerpsoc cypress.com/go/plc
Memory	cypress.com/go/memory
PSoC	cypress.com/go/psoc
Touch Sensing	cypress.com/go/touch
USB Controllers	cypress.com/go/USB
Wireless/RF	cypress.com/go/wireless

PSoC[®] Solutions

psoc.cypress.com/solutions
PSoC 1 | PSoC 3 | PSoC 4 | PSoC 5LP

Cypress Developer Community

[Community](#) | [Forums](#) | [Blogs](#) | [Video](#) | [Training](#)

Technical Support

cypress.com/go/support

© Cypress Semiconductor Corporation, 2004-2013. The information contained herein is subject to change without notice. Cypress Semiconductor Corporation assumes no responsibility for the use of any circuitry other than circuitry embodied in a Cypress product. Nor does it convey or imply any license under patent or other rights. Cypress products are not warranted nor intended to be used for medical, life support, life saving, critical control or safety applications, unless pursuant to an express written agreement with Cypress. Furthermore, Cypress does not authorize its products for use as critical components in life-support systems where a malfunction or failure may reasonably be expected to result in significant injury to the user. The inclusion of Cypress products in life-support systems application implies that the manufacturer assumes all risk of such use and in doing so indemnifies Cypress against all charges.

Any Source Code (software and/or firmware) is owned by Cypress Semiconductor Corporation (Cypress) and is protected by and subject to worldwide patent protection (United States and foreign), United States copyright laws and international treaty provisions. Cypress hereby grants to licensee a personal, non-exclusive, non-transferable license to copy, use, modify, create derivative works of, and compile the Cypress Source Code and derivative works for the sole purpose of creating custom software and or firmware in support of licensee product to be used only in conjunction with a Cypress integrated circuit as specified in the applicable agreement. Any reproduction, modification, translation, compilation, or representation of this Source Code except as specified above is prohibited without the express written permission of Cypress.

Disclaimer: CYPRESS MAKES NO WARRANTY OF ANY KIND, EXPRESS OR IMPLIED, WITH REGARD TO THIS MATERIAL, INCLUDING, BUT NOT LIMITED TO, THE IMPLIED WARRANTIES OF MERCHANTABILITY AND FITNESS FOR A PARTICULAR PURPOSE. Cypress reserves the right to make changes without further notice to the materials described herein. Cypress does not assume any liability arising out of the application or use of any product or circuit described herein. Cypress does not authorize its products for use as critical components in life-support systems where a malfunction or failure may reasonably be expected to result in significant injury to the user. The inclusion of Cypress' product in a life-support systems application implies that the manufacturer assumes all risk of such use and in doing so indemnifies Cypress against all charges.

Use may be limited by and subject to the applicable Cypress software license agreement.