

# SMD Power Inductor

## CDPQ2419



Recommended Type

### Description

- Ferrite core construction.
- Magnetically shielded.
- LxWxH:27.5x26.5x20.0mm Max.
- Product weight: 38g(Ref.)
- Moisture Sensitivity Level: 1

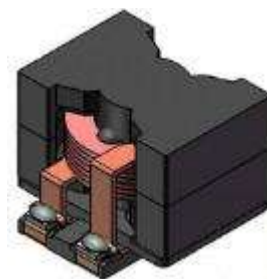

### Environmental Data

- Operating temperature range: -40°C~+125°C (including coil's self temperature rise)
- Storage temperature range: -40°C~+125°C

### Packaging

- Pallet packaging.
- 40pcs per pallet, 200pcs per package.

### Applications

- High Current Inductor for DC/DC converters in distributed power systems and PV inverters etc.

### Dimension - [mm]

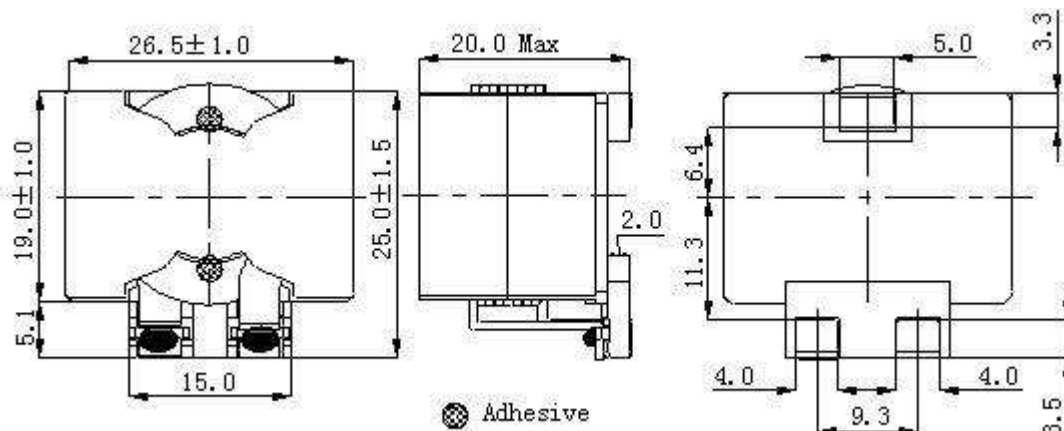

### Recommended Land pattern - [mm]

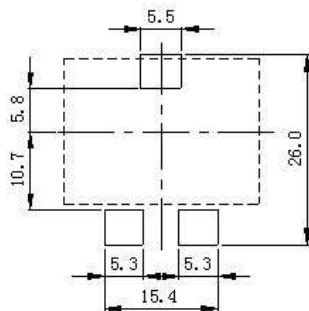

### Wire Connection

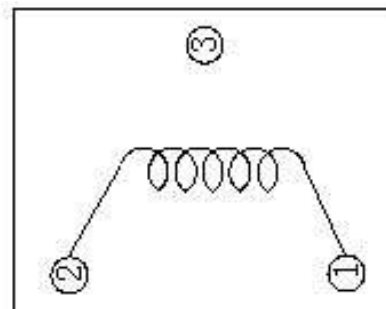

Note: This specification is subject to change without notice. Please contact your nearest sales office for updated information when placing an order.

# SMD Power Inductor

## CDPQ2419



### Electrical Characteristics

Part Number	Inductance [Within] ( $\mu$ H) ※1	D.C.R. at 20°C max(typ) (m $\Omega$ )	Saturation Current at 20°C(A) ※2	Temperature Rise Current (A) ※3
CDPQ2419NP-3R3LB-AL51	3.30 $\pm$ 15%	2.86 (2.60)	100	28.00
CDPQ2419NP-4R7LB-AL73	4.70 $\pm$ 15%	2.86 (2.60)	72.00	28.00
CDPQ2419NP-100LB-AL156	10.00 $\pm$ 15%	2.86 (2.60)	35.00	28.00
CDPQ2419NP-220LB-AL343	22.00 $\pm$ 15%	2.86 (2.60)	16.00	28.00

※1 Measuring condition at 100kHz 0.1V.

※2 Saturation current: This indicates the actual value of D.C. current when the inductance becomes 20% lower than its initial value.

※3 Temperature rise current: The actual value of D.C. current when the temperature of coil becomes  $\Delta T=40^{\circ}\text{C}$ ( $T_a=20^{\circ}\text{C}$ ).

### Solder Reflow Condition

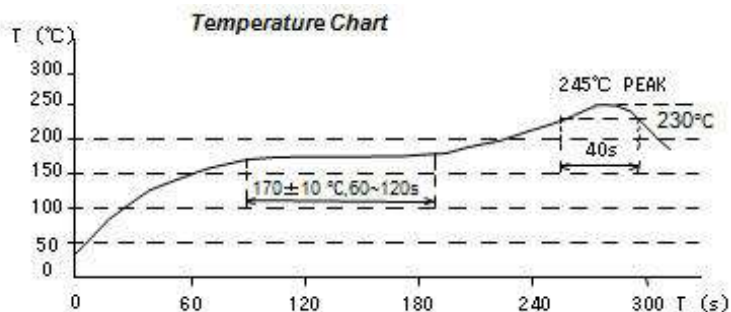
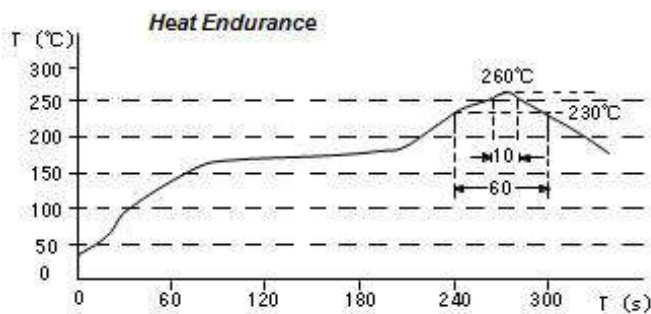

# SMD Power Inductor

## CDPQ2419



### Saturation Current & Temperature Rise Graph

— L (20°C) — ΔT

1. CDPQ2419NP-3R3LB-AL51

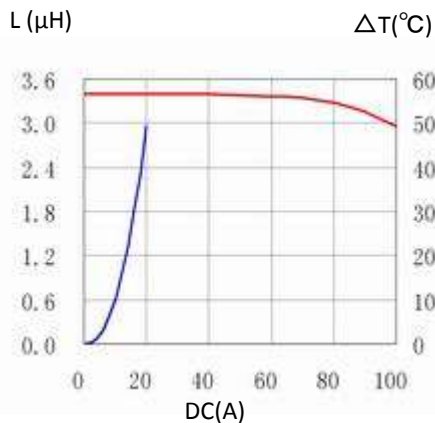

2. CDPQ2419NP-4R7LB-AL73

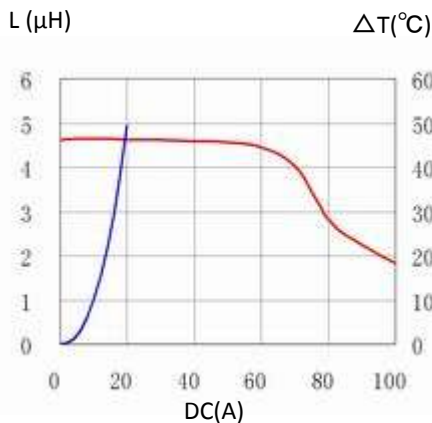

3. CDPQ2419NP-100LB-AL156

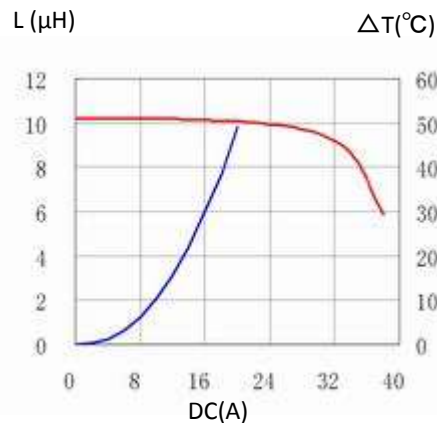

4. CDPQ2419NP-220LB-AL343

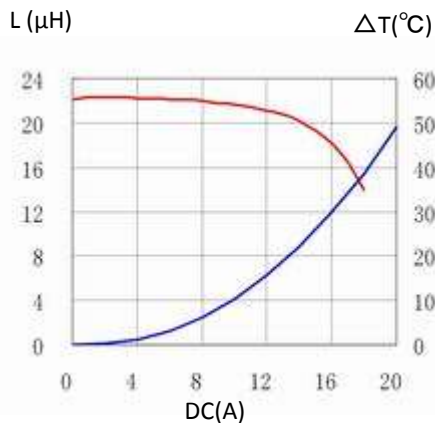

For sales office information, please [click here](#) to visit our website.