



## UMUR3060

DIODE

### SWITCHMODE POWER RECTIFIERS

#### DESCRIPTION

The UTC **UMUR3060** is a switchmode power rectifier, it uses UTC's advanced technology to provide customers with high voltage capability, low forward drop and low leakage current, etc.

The UTC **UMUR3060** is suitable for use in switching power supplies, inverters and as free wheeling diodes.

#### FEATURES

- \* Ultrafast and nanosecond recovery time
- \* High voltage capability
- \* Low forward drop
- \* Low leakage current

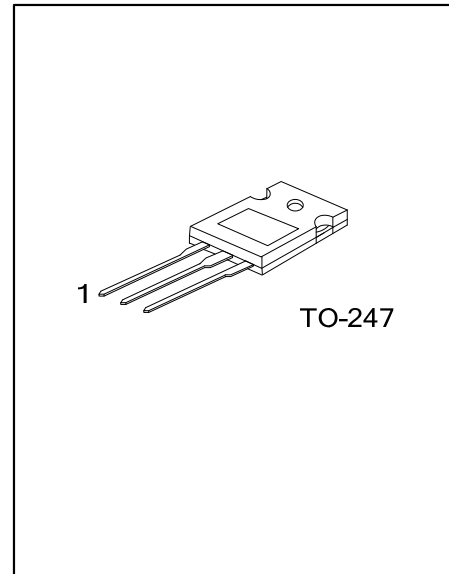

#### SYMBOL

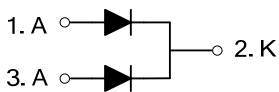

#### ORDERING INFORMATION

Ordering Number		Package	Pin Assignment			Packing
Lead Free	Halogen Free		1	2	3	
UMUR3060L-T47-T	UMUR3060G-T47-T	TO-247	A	K	A	Tube

<p>UMUR3060L-T47-T</p> <p>(1) Packing Type (2) Package Type (3) Green Package</p>	<p>(1) T: Tube (2) T47: TO-247 (3) L: Lead Free, G: Halogen Free and Lead Free</p>
-------------------------------------------------------------------------------------------	--------------------------------------------------------------------------------------------

#### MARKING

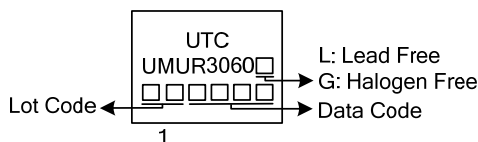

## ■ ABSOLUTE MAXIMUM RATINGS

PARAMETER	SYMBOL	RATINGS	UNIT	
Repetitive Peak Reverse Voltage	$V_{RRM}$	600	V	
Working Peak Reverse Voltage	$V_{RWM}$	600	V	
DC Blocking Voltage	$V_R$	600	V	
Average Forward Current	$I_O$	$T_C=140^{\circ}\text{C}$	15	A
		Total Device	30	A
Nonrepetitive Peak Surge Current (Surge applied at rated load conditions, halfwave, single phase, 60 Hz)	$I_{FSM}$	180	A	
Operating Junction Temperature	$T_J$	-65~+150	$^{\circ}\text{C}$	
Storage Temperature	$T_{STG}$	-65~+150	$^{\circ}\text{C}$	

Note: Absolute maximum ratings are those values beyond which the device could be permanently damaged.

Absolute maximum ratings are stress ratings only and functional device operation is not implied.

## ■ THERMAL RESISTANCE

PARAMETER	SYMBOL	RATINGS	UNIT
Junction to Ambient	$\theta_{JA}$	40	$^{\circ}\text{C}/\text{W}$
Junction to Case	$\theta_{JC}$	1.5	$^{\circ}\text{C}/\text{W}$

## ■ ELECTRICAL CHARACTERISTICS

Single phase, half wave, 60Hz, resistive or inductive load.

For capacitance load, derate current by 20%.

PARAMETER	SYMBOL	TEST CONDITIONS	MIN	TYP	MAX	UNIT
Reverse Breakdown Voltage (Note 1)	$V_{(BR)R}$	$I_R=1\text{mA}$	600			V
Forward Voltage Drop	$V_{FM}$	$I_F=15\text{A}, T_C=25^{\circ}\text{C}$			1.7	V
		$I_F=15\text{A}, T_C=150^{\circ}\text{C}$			1.4	V
Leakage Current (Note 1)	$I_{RM}$	Rated DC voltage, $T_J=150^{\circ}\text{C}$			1000	$\mu\text{A}$
		Rated DC voltage, $T_J=25^{\circ}\text{C}$			10	$\mu\text{A}$
Maximum Reverse Recovery Time	$t_{rr}$	$I_F=1.0\text{A}, di/dt=50\text{A}/\mu\text{s}$			60	ns

Notes: 1. Short duration pulse test used to minimize self-heating effect.

2. Thermal resistance junction to case mounted on heatsink.

## TYPICAL CHARACTERISTICS

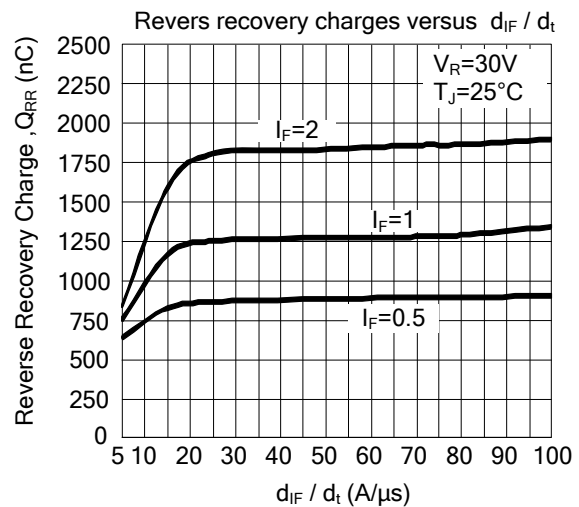
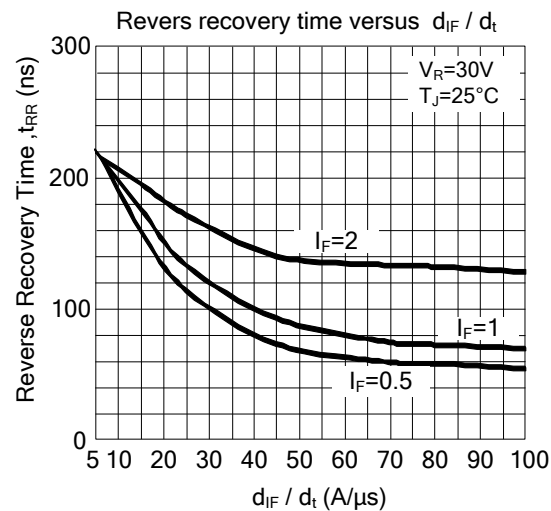
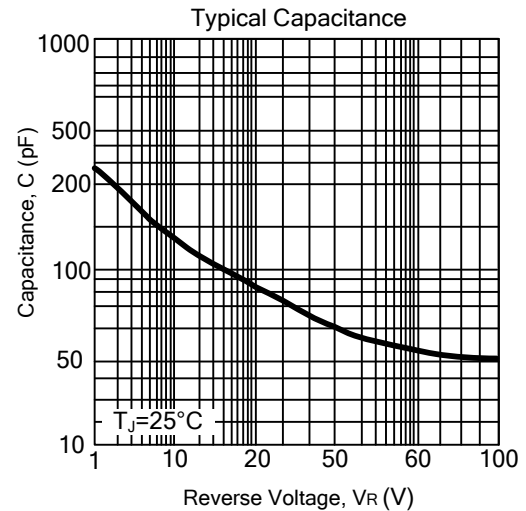
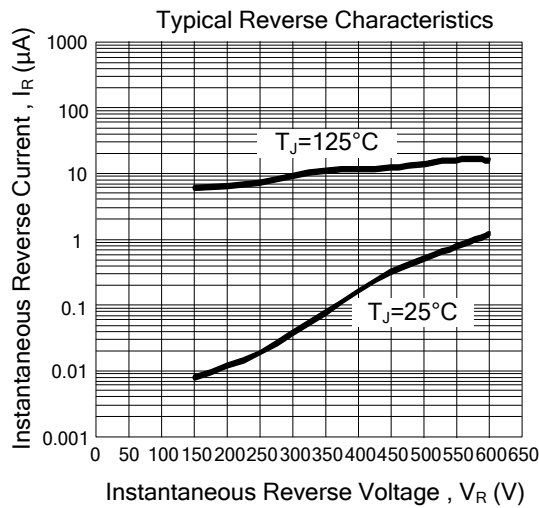
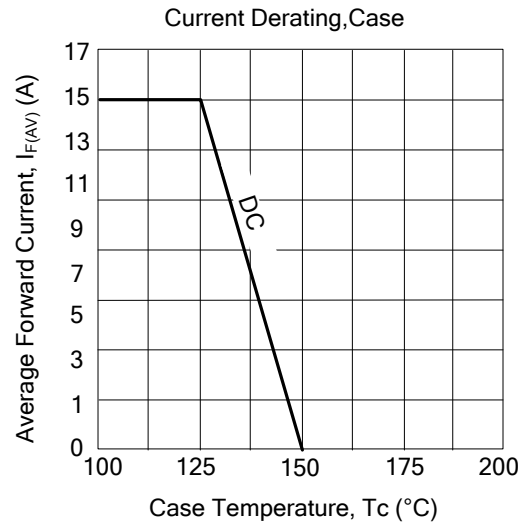
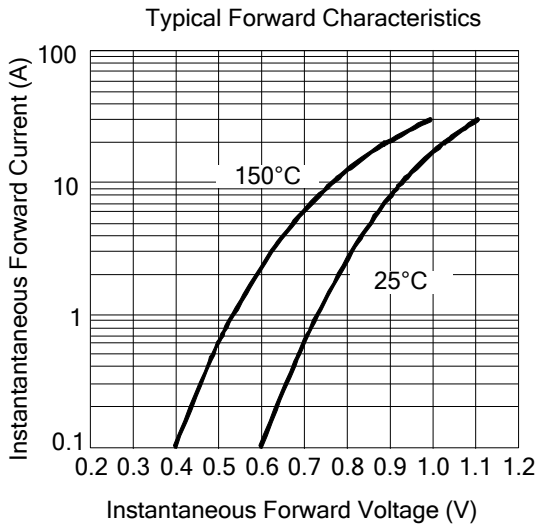

■ TYPICAL CHARACTERISTICS (Cont.)

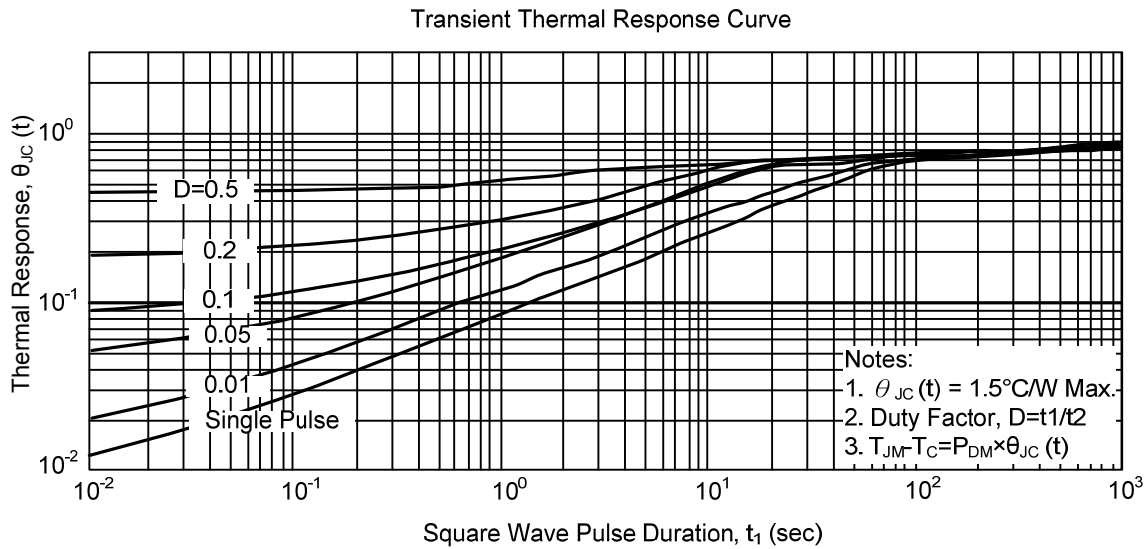

UTC assumes no responsibility for equipment failures that result from using products at values that exceed, even momentarily, rated values (such as maximum ratings, operating condition ranges, or other parameters) listed in products specifications of any and all UTC products described or contained herein. UTC products are not designed for use in life support appliances, devices or systems where malfunction of these products can be reasonably expected to result in personal injury. Reproduction in whole or in part is prohibited without the prior written consent of the copyright owner. The information presented in this document does not form part of any quotation or contract, is believed to be accurate and reliable and may be changed without notice.