

Pin Definition:
 1. Gate
 2. Drain
 3. Source

Key Parameter Performance

Parameter	Value	Unit
V_{DS}	600	V
$R_{DS(on)}(max)$	4	
Q_g (typ)	9.5	nC

Features

- 100% Avalanche Tested
- G-S ESD Protection Diode Embedded

Ordering Information

Part No.	Package	Packing
TSM2N60ECH C5G	TO-251	75pcs / Tube
TSM2N60ECP ROG	TO-252	2.5kpcs / 13+Reel

Note: %G+denotes for Halogen- and Antimony-free as those which contain <900ppm bromine, <900ppm chlorine (<1500ppm total Br + Cl) and <1000ppm antimony compounds

Block Diagram

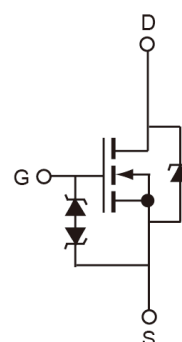

N-Channel MOSFET with ESD Protection

Absolute Maximum Ratings ($T_C = 25^\circ\text{C}$ unless otherwise noted)

Parameter	Symbol	Limit	Unit
Drain-Source Voltage	V_{DS}	600	V
Gate-Source Voltage	V_{GS}	± 30	V
Continuous Drain Current ^(Note 1)	I_D	$T_C = 25^\circ\text{C}$	2
		$T_C = 100^\circ\text{C}$	1.43
Pulsed Drain Current ^(Note 2)	I_{DM}	8	A
Repetitive Avalanche Current ^(Note 1)	I_{AR}	2	A
Repetitive Avalanche Energy ^(Note 1)	E_{AR}	5.2	A
Single Pulse Avalanche Energy ^(Note 3)	E_{AS}	66	mJ
Total Power Dissipation	P_D	$T_C = 25^\circ\text{C}$	52.1
		Derate above $T_C = 25^\circ\text{C}$	0.416
Peak Diode Recovery dV/dt ^(Note 4)	dV/dt	4.5	V/ns
Operating Junction Temperature	T_J	-55 to +150	$^\circ\text{C}$
Storage Temperature Range	T_{STG}	-55 to +150	$^\circ\text{C}$

Thermal Performance

Parameter	Symbol	Limit	Unit
Thermal Resistance - Junction to Case	R_{JC}	2.4	$^\circ\text{C/W}$
Thermal Resistance - Junction to Ambient	R_{JA}	110	$^\circ\text{C/W}$

Electrical Specifications ($T_C = 25^\circ\text{C}$ unless otherwise noted)

Parameter	Conditions	Symbol	Min	Typ	Max	Unit
Static (Note 5)						
Drain-Source Breakdown Voltage	$V_{GS} = 0V, I_D = 250\mu A$	BV_{DSS}	600	--	--	V
Drain-Source On-State Resistance	$V_{GS} = 10V, I_D = 1A$	$R_{DS(ON)}$	--	3.2	4	
Gate Threshold Voltage	$V_{DS} = V_{GS}, I_D = 250\mu A$	$V_{GS(TH)}$	3	--	5	V
Zero Gate Voltage Drain Current	$V_{DS} = 600V, V_{GS} = 0V$	I_{DSS}	--	--	1	μA
	$V_{DS} = 480V, T_J = 125^\circ\text{C}$		--	--	10	
Gate Body Leakage	$V_{GS} = \pm 30V, V_{DS} = 0V$	I_{GSS}	--	--	± 100	μA
Forward Transconductance	$V_{DS} = 30V, I_D = 1A$	g_{fs}	--	3	--	S
Dynamic (Note 6)						
Total Gate Charge	$V_{DS} = 480V, I_D = 2A,$ $V_{GS} = 10V$	Q_g	--	9.5	--	nC
Gate-Source Charge		Q_{gs}	--	2.1	--	
Gate-Drain Charge		Q_{gd}	--	3.9	--	
Input Capacitance	$V_{DS} = 25V, V_{GS} = 0V,$ $f = 1\text{MHz}$	C_{iss}	--	362	--	pF
Output Capacitance		C_{oss}	--	40	--	
Reverse Transfer Capacitance		C_{rss}	--	7.2	--	
Switching (Note 7)						
Turn-On Delay Time	$V_{DD} = 300V, V_{GS} = 10V,$ $R_G = 25\Omega, I_D = 2A$	$t_{d(on)}$	--	21	--	ns
Turn-On Rise Time		t_r	--	22	--	
Turn-Off Delay Time		$t_{d(off)}$	--	41	--	
Turn-Off Fall Time		t_f	--	21	--	
Source-Drain Diode Ratings and Characteristic (Note 5)						
Maximum Continuous Drain-Source Diode Forward Current		I_S	--	--	2	A
Maximum Pulse Drain-Source Diode Forward Current		I_{SM}	--	--	8	A
Diode-Source Forward Voltage	$V_{GS} = 0V, I_S = 2A$	V_{SD}	--	--	1.5	V
Reverse Recovery Time	$V_{GS} = 0V, I_S = 2A$	t_{rr}	--	238	--	ns
Reverse Recovery Charge	$di_f/dt = 100A/\mu s$	Q_{rr}	--	0.8	--	nC

Notes:

- Current limited by package
- Pulse width limited by the maximum junction temperature
- $V_{DD} = 50V, L = 30.5\text{mH}, I_{AS} = 2A, R_G = 25\Omega, \text{Starting } T_J = 25^\circ\text{C}$
- $I_{SD} \text{ m}2A, di/dt \text{ m}200A/\mu s, V_{DD} \text{ m}BV_{DS}, \text{Starting } T_J = 25^\circ\text{C}$
- Pulse test: PW m300 μs , duty cycle m2%
- For DESIGN AID ONLY, not subject to production testing.
- Switching time is essentially independent of operating temperature.

Electrical Characteristics Curves ($T_C = 25^\circ\text{C}$, unless otherwise noted)

Output Characteristics

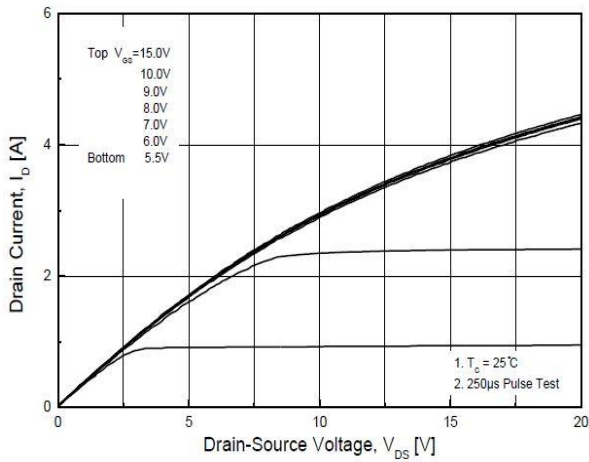

Transfer Characteristics

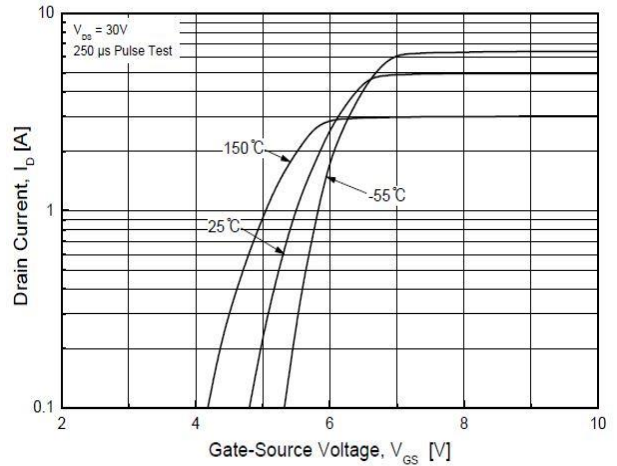

On-Resistance vs. Drain Current

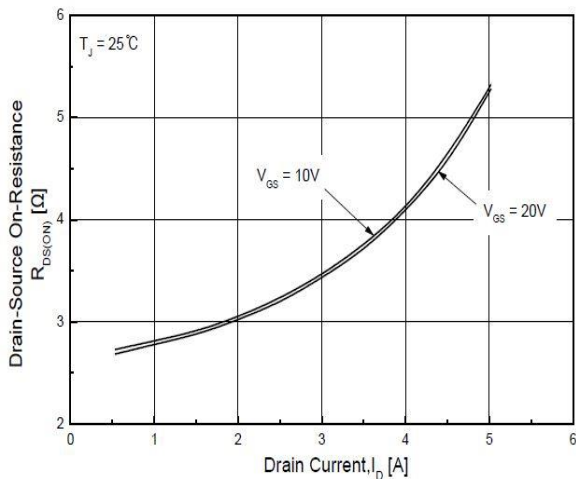

Gate Charge

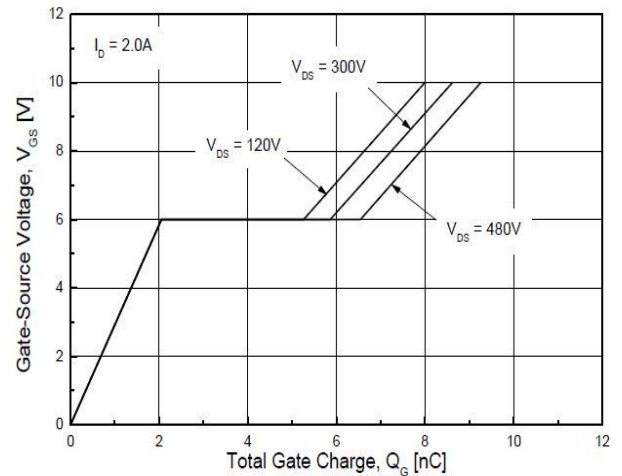

On-Resistance vs. Junction Temperature

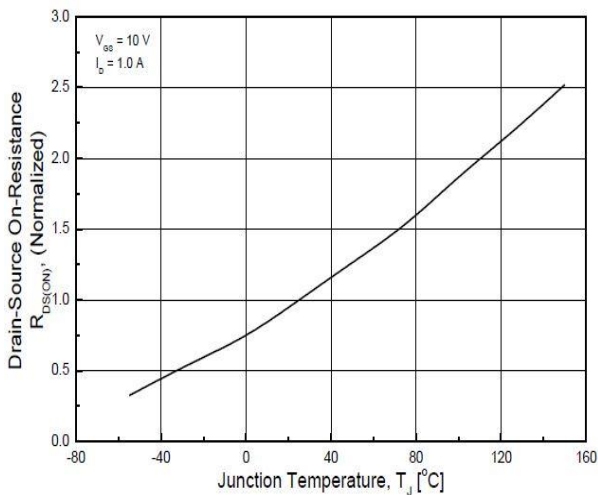

Source-Drain Diode Forward Voltage

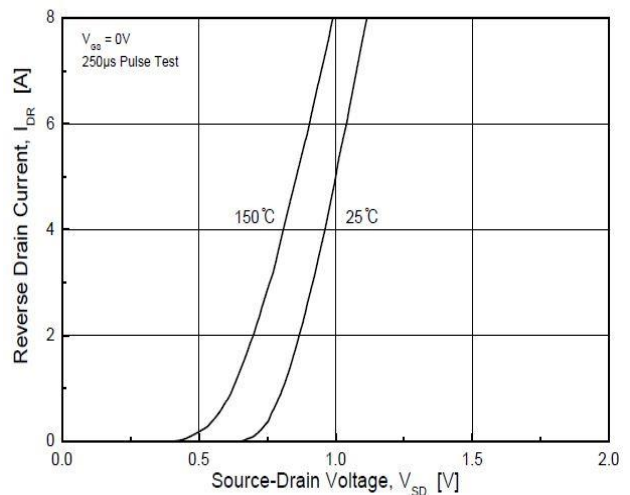

Electrical Characteristics Curve ($T_C = 25^\circ\text{C}$, unless otherwise noted)

Drain Current vs. Case Temperature

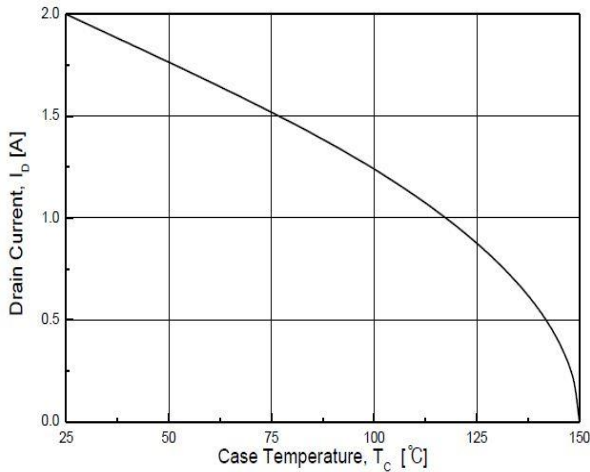

BV_{DSS} vs. Junction Temperature

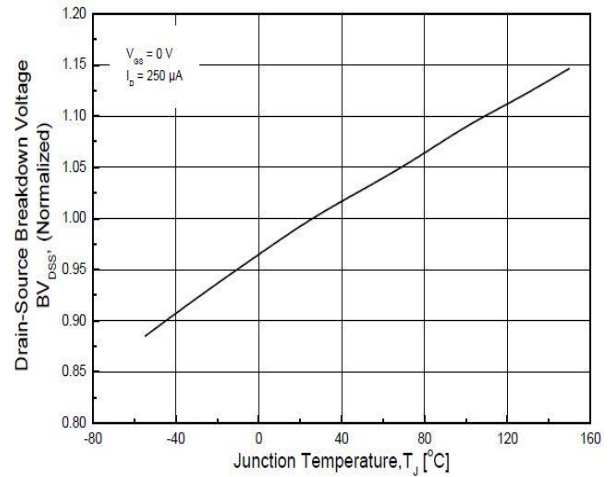

Threshold Voltage vs. Junction Temperature

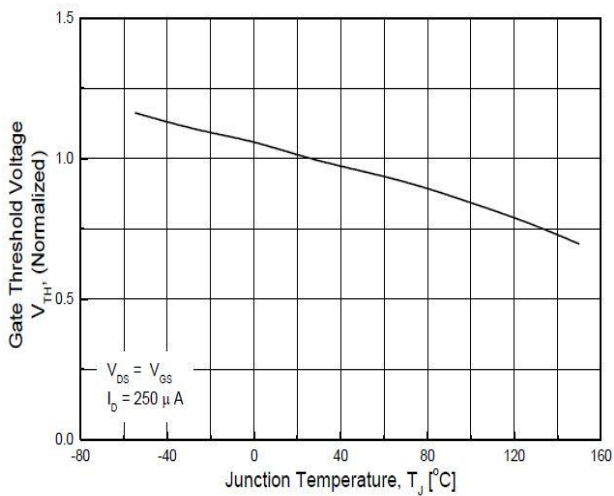

Capacitance vs. Drain-Source Voltage

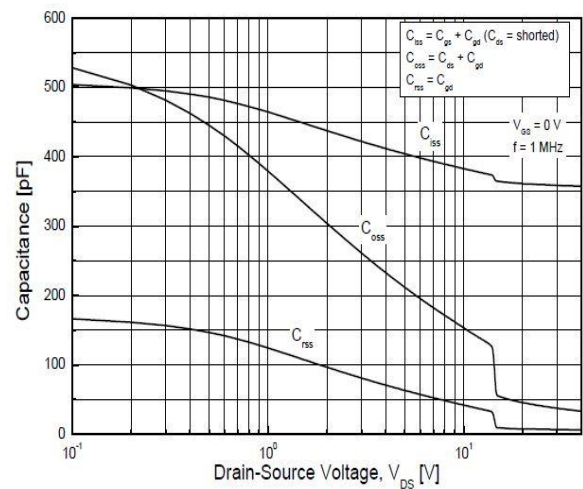

Maximum Safe Operating Area

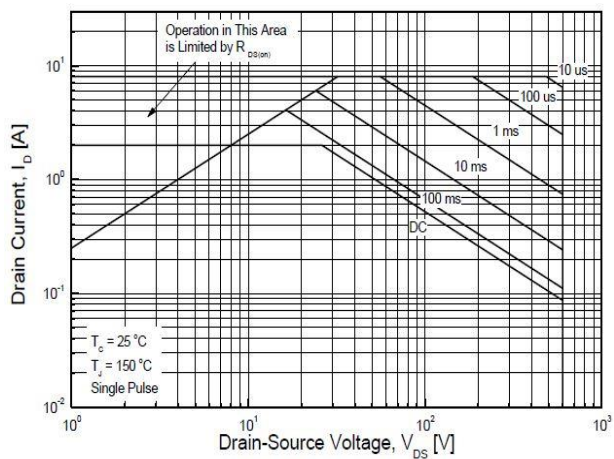

Normalized Transient Impedance

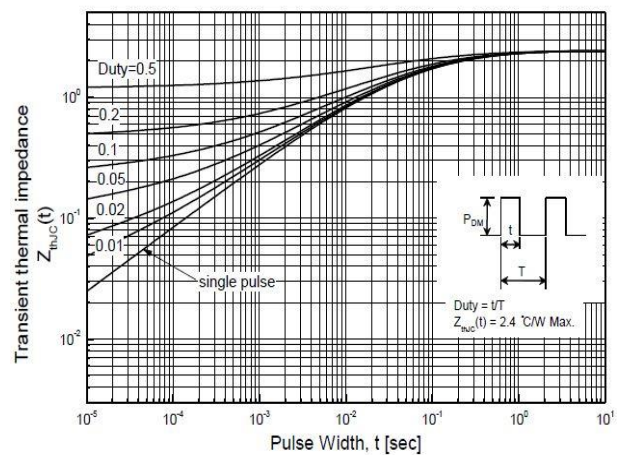

TO-251 Mechanical Drawing

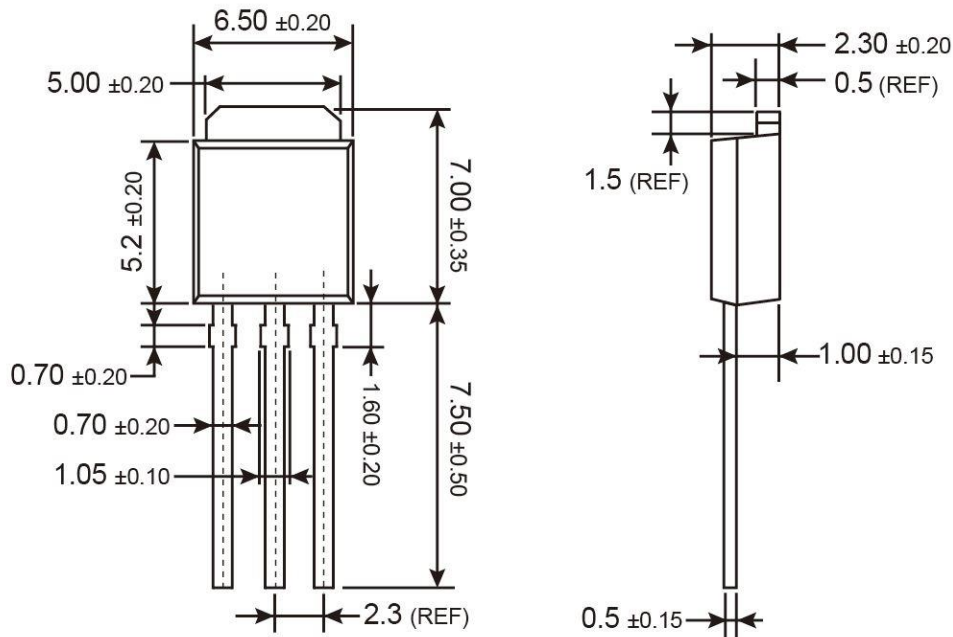

Unit: Millimeters

Marking Diagram

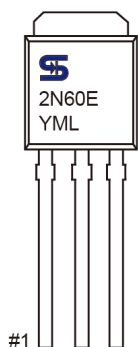

- Y** = Year Code
- M** = Month Code for Halogen Free Product
(**O**=Jan, **P**=Feb, **Q**=Mar, **R**=Apr, **S**=May, **T**=Jun, **U**=Jul, **V**=Aug, **W**=Sep, **X**=Oct, **Y**=Nov, **Z**=Dec)
- L** = Lot Code

TO-252 Mechanical Drawing

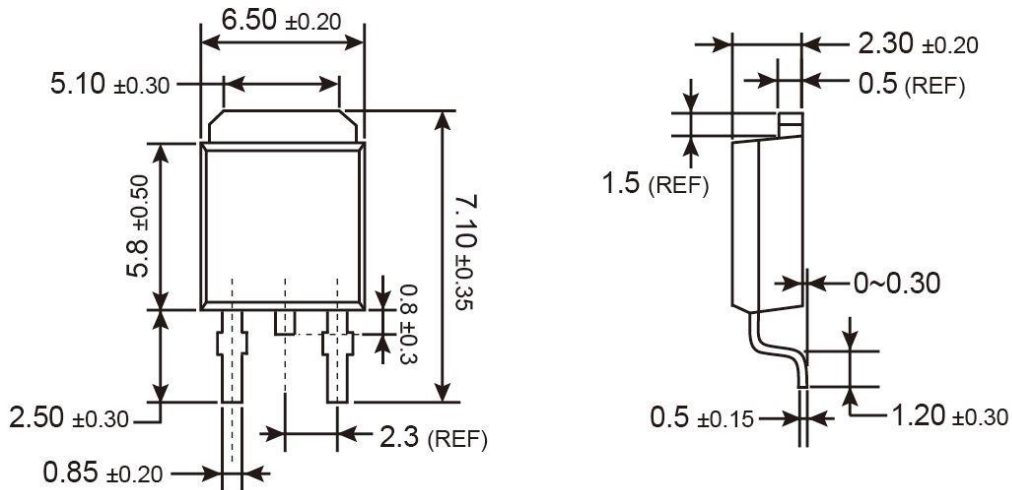

Unit: Millimeters

Marking Diagram

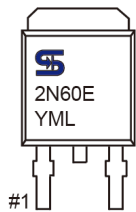

- Y** = Year Code
- M** = Month Code for Halogen Free Product
(O=Jan, P=Feb, Q=Mar, R=Apr, S=May, T=Jun, U=Jul, V=Aug, W=Sep, X=Oct, Y=Nov, Z=Dec)
- L** = Lot Code

Notice

Specifications of the products displayed herein are subject to change without notice. TSC or anyone on its behalf, assumes no responsibility or liability for any errors or inaccuracies.

Information contained herein is intended to provide a product description only. No license, express or implied, to any intellectual property rights is granted by this document. Except as provided in TSC's terms and conditions of sale for such products, TSC assumes no liability whatsoever, and disclaims any express or implied warranty, relating to sale and/or use of TSC products including liability or warranties relating to fitness for a particular purpose, merchantability, or infringement of any patent, copyright, or other intellectual property right.

The products shown herein are not designed for use in medical, life-saving, or life-sustaining applications. Customers using or selling these products for use in such applications do so at their own risk and agree to fully indemnify TSC for any damages resulting from such improper use or sale.