

Wire-wound Type Power Inductor

SCWL252012 Series

Features

- u High saturation current realized by material properties and structure design
- u Low DC resistance to achieve high conversion efficiency and low temperature rising
- u Low profile: 2.5mm×2.0mm×1.2mm
- u Magnetically shielded structure to accomplish high resolution in EMC protection
- u Halogen free, Lead free, RoHS compliance

Applications

SCWL series is generic applied in portable DC to DC converter line.

- u Smart Phone, PAD
- u DC/DC converter
- u Thin-type power supply module

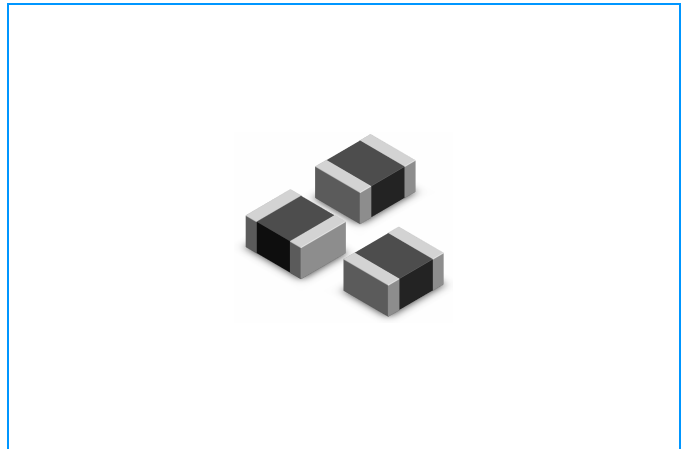

General Technical Data

| | | |
|---|----------------------------|---------------|
| Operating Temperature Range | | -40 ~ +125°C |
| Storage Temperature Range | | -50 ~ +125°C |
| Taping package Storage condition | Storage Temperature | 5 ~ 40°C |
| | Relative Humidity | < 65% |
| | Storage Time | 12 Months max |

Part Numbering

SCWL **2520** **12** **R47** **M** **T** **F**
 (1) (2) (3) (4) (5) (6) (7)

- 1 Series Name, wire-wound type power inductor
- 2 Size Code: the first two digitals : length(mm), the last two digitals : width(mm)
- 3 Thickness (mm)
- 4 Inductance (μH), eg. 2R2=2.2μH; R47=0.47μH
- 5 Inductance tolerance, M: ±20%
- 6 Packaging: T - Embossed plastic tape, 7" reel.
- 7 Soldering : Green Parts, F - Lead-Free for whole chip

Wire-wound Type Power Inductor

SCWL252012 Series

Electrical Characteristics

| Part Number | Initial Inductance Li (μH) @1mA | DC Resistance R _{DC} (mΩ) | | Saturation Current Isat (A) | | Heat Rating Current Irms (A) | |
|------------------|------------------------------------|---------------------------------------|---------|--------------------------------|---------|---------------------------------|---------|
| | | Typical | Maximum | Typical | Maximum | Typical | Maximum |
| SCWL252012R47MTF | 0.47 | 22 | 28 | 6 | 5.5 | 4.5 | 4.0 |
| SCWL252012R68MTF | 0.68 | 30 | 38 | 5.5 | 5 | 4.3 | 3.9 |
| SCWL2520121R0MTF | 1.0 | 44 | 54 | 4.5 | 4 | 3.1 | 2.7 |
| SCWL2520122R2MTF | 2.2 | 85 | 102 | 3 | 2.7 | 2.3 | 2.0 |

Note:

1. All test data is referenced to 26 °C ambient.
2. Inductance is measured by LCR meter, Test frequency at 1MHz
3. Inductance Tolerance: ±20%.
4. DC resistance is measured by micro-ohm meter.
5. Isat means that DC current will cause a 30% inductance reduction form initial value.
6. Irms means that DC current will cause coil temperature rising to 40 °C whichever is smaller.

Current Characteristics

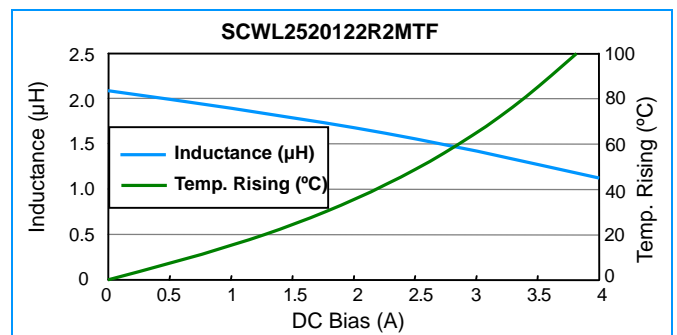
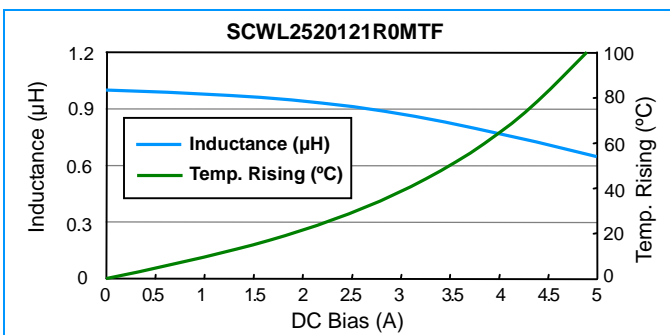
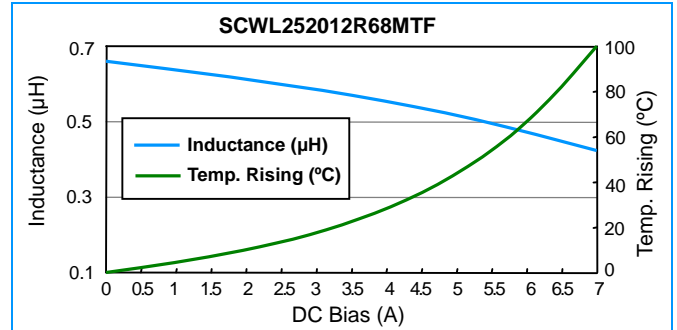
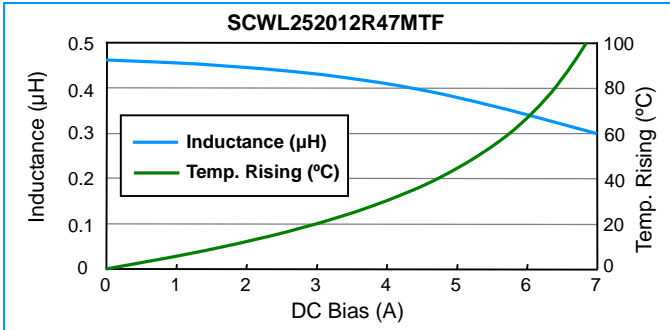

Wire-wound Type Power Inductor

SCWL252012 Series

Soldering Parameters

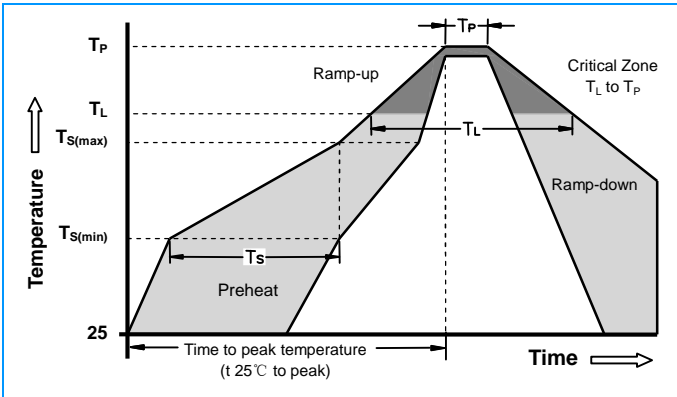

| | | |
|--|------------------------------------|------------------|
| Reflow Condition | | Pb free assembly |
| Pre Heat | -Temperature Min ($T_{s(min)}$) | +150°C |
| | -Temperature Max ($T_{s(max)}$) | +200°C |
| | -Time (min to max) (T_s) | 60 - 180 Seconds |
| Average ramp up rate (Liquidus Temp T_L to peak) | | 3°C/Second Max |
| $T_{s(max)}$ to T_L - Ramp-up Rate | | 3°C/Second Max |
| Reflow | - Temperature (T_L) (Liquidus) | +217°C |
| | - Time (min to max) (T_L) | 60 - 150 Seconds |
| Peak Temperature (T_P) | | 260 +0/-5°C |
| Time within 5°C of actual peak Temperature (T_P) | | 20-40 Seconds |
| Ramp-down Rate | | 6°C/Second Max |
| Time 25°C to peak Temperature (T_P) | | 8 minutes Max |

Precaution for Soldering

Note that this product will be easily damaged by rapid heating, rapid cooling or local heating. Do not give heat shock over 100°C in the process of soldering. We recommend to take preheating and gradual cooling

Soldering gun procedure

Note the follows, in case of using solder gun for replacement.
 1) The tip temperature must be less than 280 for the period within 3 seconds by using soldering gun under 30W
 2) The soldering gun tip shall not touch this product directly.

Soldering volume

Note that excess of soldering volume will easily get crack the body of this product.

Precaution for Handling of Substrate

Do not exceed to bend the board after soldering this product extremely. (reference examples)

- I Mounting place must be as far as possible from the position, which is close to the break line of board, or on the line of large holes of board.
- I Do not bend extremely the board, in mounting another component. If necessary, use back-up pin (support pin) to prevent from bending extremely.
- I Do not break the board by hand. We recommend to use the machine or the jig to break it.

Construction & Dimensions

Core Material: Iron

End termination: Ni / Sn

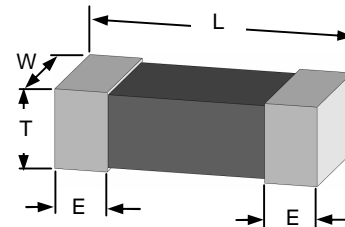

Unit: mm

| L | W | T | E |
|---------|---------|---------|---------|
| 2.5±0.2 | 2.0±0.2 | 1.2 Max | 0.6±0.2 |

Recommended Pad Layout

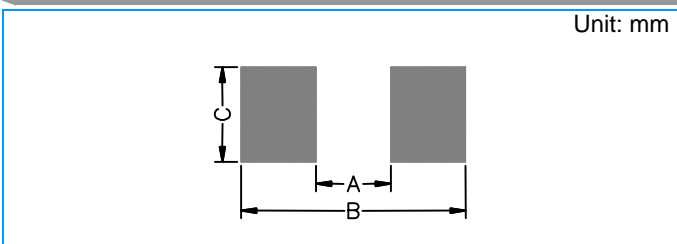

| A | B | C |
|-----|-----|-----|
| 1.2 | 2.8 | 2.0 |

Wire-wound Type Power Inductor

SCWL252012 Series

Tape Specifications

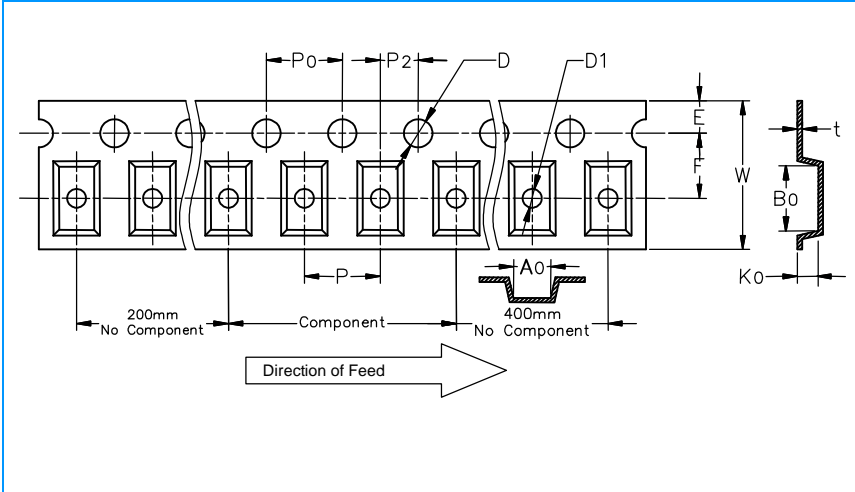

| Symbol | 252012 |
|--------|-----------|
| W | 8.00±0.3 |
| E | 1.75±0.10 |
| F | 3.50±0.05 |
| D | 1.55±0.05 |
| P | 4.00±0.10 |
| P0 | 4.00±0.10 |
| P2 | 2.00±0.05 |
| A0 | 2.50±0.10 |
| B0 | 3.00±0.10 |
| K0 | 1.60±0.10 |
| t | 0.25±0.05 |

Reel Specifications & Packaging

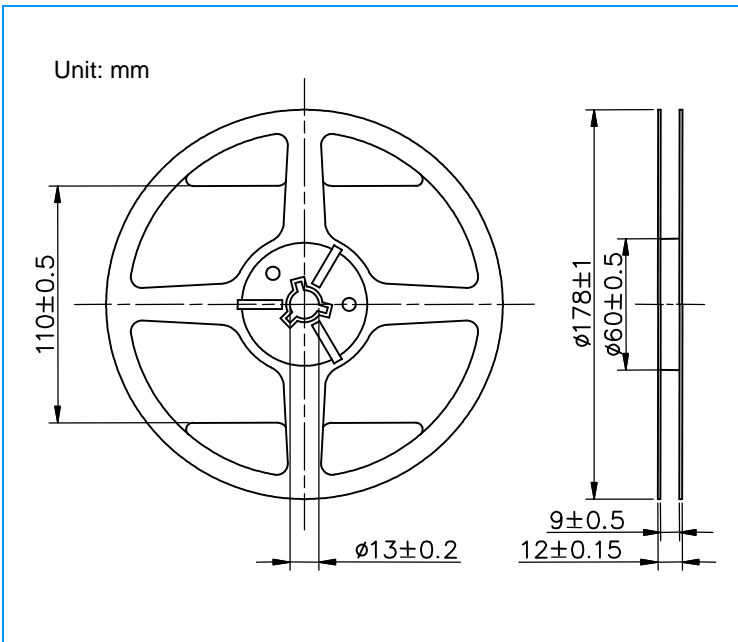

| Part Size (EIA Size) | Packaging Option | Quantity |
|----------------------|------------------|----------|
| 2520 (1008) | 7"Reel | 3,000 |

The Contents of a box:
252010(1008): 6 reels / inner box

Wire-wound Type Power Inductor

SCWL252012 Series

Reliability and Test Condition

| Test Item | Test Condition | Criteria |
|----------------------------------|---|---|
| Resistance to Solder Heat | <ol style="list-style-type: none"> Solder temperature : 260±5℃ Flux : Rosin DIP time : 10±1 sec | <ol style="list-style-type: none"> More than 95 % of terminal electrode should be covered with new solder No mechanical damage Induction value should be within ±20 % of the initial value |
| Adhesive Test | <ol style="list-style-type: none"> Reflow temperature : 245℃ It shall be Soldered on the substrate applying direction parallel to the substrate Apply force(F) : 5 N Test time : 10 sec | <ol style="list-style-type: none"> No mechanical damage Soldering the products on PCB after the pulling test force > 5 N |
| Temperature Cycle | <ol style="list-style-type: none"> Temperature : -50 ~ +125℃ for 30 minutes each Cycle : 500 cycles Measurement : At ambient temperature 24 hours after test completion | <ol style="list-style-type: none"> No mechanical damage Induction value should be within ±20 % of the initial value |
| Dry Heat Test | <ol style="list-style-type: none"> Temperature : 85℃±5℃ Test time : 500 hours Apply current : full rated current Measurement : At ambient temperature 24 hours after test completion | <ol style="list-style-type: none"> No mechanical damage Induction value should be within ±20 % of the initial value |
| Humidity Test | <ol style="list-style-type: none"> Temperature : 60℃±2℃ Humidity : 90 ~ 95 % RH Apply current : full rated current Test time : 500 hours Measurement : At ambient temperature 24 hours after test completion | <ol style="list-style-type: none"> No mechanical damage Induction value should be within ±20 % of the initial value |