



**PLEDDC-200W Series, Fixed Output & Dimmable
AC or DC Input
Flicker-Free LED Drivers
Constant Current & Constant Voltage with Isolation
Black Magic Thermal Advantage™ Aluminum Housing**

Electrical Specifications

Input Voltage Range: 100-277 Vac Nom. (90-305 V Min/Max), 108-250 Vdc

Frequency: 50/60 Hz Nom. (47-63 Hz Min/Max)

Power Factor: >0.90 @ > 70% load, 120-277V

Inrush Current: <30 Amps max @ 277Vac, cold start, full load

Input Current: 0.96 Amps max @ 230Vac, 1.82 A max @ 120Vac

Maximum Power: 200W

Current Regulation: ± 3% Over input line variation

Load Regulation: ± 4%

THD: ≤ 20% @ > 70% load, 120-277V

Ripple & Noise (Vpk-pk): 5% Vo max @ 20 MHz BW, Full load output in parallel with 0.1 µF ceramic & 10 µF Electrolytic

Ripple (Ipk-pk): 5% Io max @ 20 MHz BW, Full load output in parallel with 0.1 µF ceramic & 10 µF Electrolytic. 120 Hz component (Flicker Free)

Start-up Time: 150mS typical @ Full Load, 120Vac/60Hz (1000mS max)

Leakage Current: 0.68 mA max @ 120Vac, 0.75 mA max @ 277Vac

Hold Up Time: 30mS typical @ Full Load, 277Vac

Protection: Over-Voltage, Over-Current, and Short Circuit (reset by power cycling)

Environmental Specifications

Minimum Starting Temp: -30°C

Maximum Case Temp: 90°C

Storage Temperature: -40°C to +85°C

Humidity: 5% to 95%

Cooling: Convection

Vibration Frequency: 5 to 55 Hz/2g, 30 minutes

Sound Rating: Class A

MTBF: 280,000 Hours at full load and 40°C ambient conditions per MIL-217F Notice 2

EMC: FCC 47CFR Part 15 Class B compliant

Impact Resistance: 1g/s

Weight: 33.2 oz (940 grams)



- Total Power: 200 Watts
- Input Voltage: 100-277 Vac Nom. or 108-250 Vdc
- UL Dry & Damp Location Rated
- IP66 & NEMA6
- High Power Factor
- UL Type HL Rated for Hazardous Locations

Constant Current Versions - Product Specifications

Model Number	Output Current (mA ±5%)	Output Voltage Range (Vdc)	Max Output Power (W)	Typical Efficiency
PLEDDC200W-445-C0450-XX	450	149-445	200W	92%
PLEDDC200W-285-C0700-XX	700	95-285	200W	92%
PLEDDC200W-190-C1050-XX	1050	64-190	200W	91%
PLEDDC200W-142-C1400-XX	1400	48-142	200W	91%
PLEDDC200W-114-C1750-XX	1750	38-114	200W	91%
PLEDDC200W-095-C2100-XX	2100	32-95	200W	91%
PLEDDC200W-081-C2450-XX	2450	27-81	200W	90%
PLEDDC200W-071-C2800-XX	2800	24-71	200W	90%
PLEDDC200W-063-C3150-XX	3150	21-63	200W	90%
PLEDDC200W-057-C3500-XX	3500	19-57	200W	90%
PLEDDC200W-047-C4200-XX	4200	16-47	200W	89%
PLEDDC200W-040-C4900-XX	4900	14-40	200W	89%
PLEDDC200W-035-C5600-XX	5600	12-35	200W	89%
PLEDDC200W-032-C6300-XX	6300	11-32	200W	88%
PLEDDC200W-024-C8330-XX	8330	8-24	200W	88%

-XX indicates dimming options are available. See options at left. Blank = fixed current output

Ordering Options:

- D: 0-10V & Resistance dimmable models dim 100-10%. Two extra wires on the output side (+Purple/-Gray). Compatible with most quality 0-10V wall dimmers. See page 3.
- PD: PWM Dimmable models. Two extra wires on the output side(+Purple/-Gray). Dims via positive 10% to 100% Duty Cycle, 200Hz to 1KHz, 0-10V Pulse. See page 4.

Constant Voltage Versions - Product Specifications

Model Number	Output Voltage (Vdc ±5%)	Output Current Range (mA)	Max Output Power (W)	Typical Efficiency
PLEDDC200W-024	24	2083-8330	200W	88%
PLEDDC200W-032	32	1575-6300	200W	88%
PLEDDC200W-035	35	1400-5600	200W	89%
PLEDDC200W-040	40	1225-4900	200W	89%
PLEDDC200W-047	47	1050-4200	200W	89%
PLEDDC200W-057	57	875-3500	200W	90%
PLEDDC200W-063	63	788-3150	200W	90%
PLEDDC200W-071	71	700-2800	200W	90%
PLEDDC200W-081	81	613-2450	200W	90%
PLEDDC200W-095	95	525-2100	200W	91%
PLEDDC200W-114	114	438-1750	200W	91%
PLEDDC200W-142	142	350-1400	200W	91%
PLEDDC200W-190	190	163-1050	200W	91%
PLEDDC200W-285	285	175-700	200W	92%
PLEDDC200W-445	445	113-450	200W	92%



Note:
LED drivers are designed and intended to operate LED loads only. Non-LED loading may be outside the specified design limits of our LED drivers, and therefore cannot be covered by any warranty. If you desire to use our LED drivers to operate non-LED loads please contact us to discuss compatibility.
Specifications subject to change without notice.

Dimensions - Inches (mm)

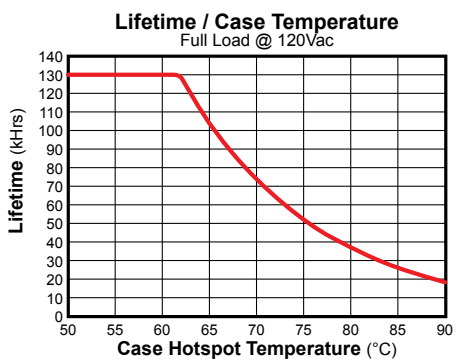
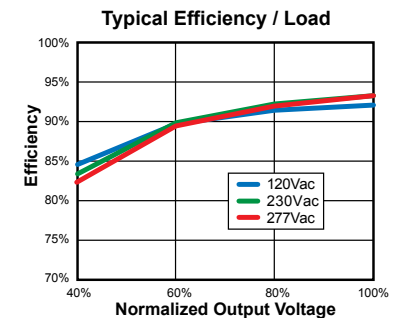
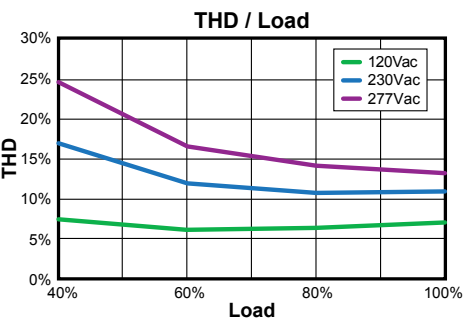
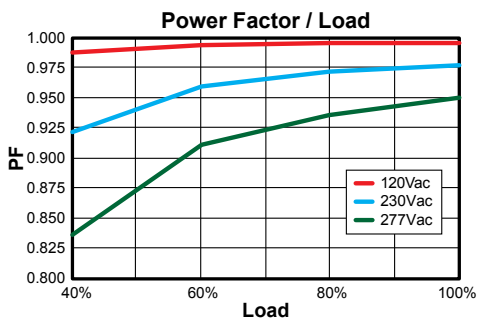
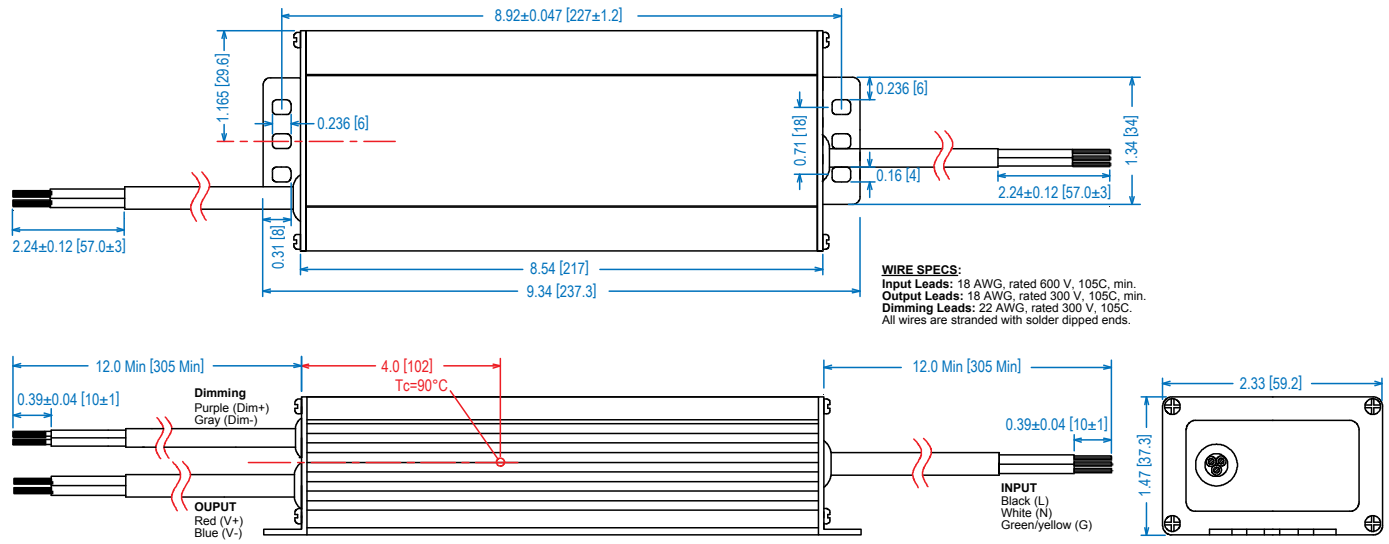

Safety and EMC Compliance	
UL/CUL	UL8750 & CAN/CSA-22.2 No. 250.13-12, UL1012/CSA-C22.2 No.107.1
CE	EN 61347-1, EN61347-2-13
FCC, 47CFR Part 15	Class B
EN 55015	Limits and methods of measurement of radio disturbance characteristics of electrical lighting and similar equipment.
EN 61000-3-2	Part 3-2: Limits for harmonic current emissions Class C, >80% Rated Power
EN 61000-3-3	Part 3-3: Limitation of voltage changes, voltage fluctuations and flicker.
EN 61000-4-5	Part 4-5: Surge Immunity test, 2 kV L-N, 4 kV L-G & N-G

Note:
 Life calculations are based on reliability with confidence using a 90% confidence level and <5% failure rate. At a confidence level of 90% it is expected that <5% of the parts will fail at the rated life provided. (Failure is defined as a driver drifting outside specification, rather than fail to operate)

UL Conditions of Acceptability
 See website for additional information

"-D" Option: 0-10VDC and Resistance Dimming

Parameters	Minimum	Typical	Maximum
10V Output, Yellow Wire	9.2V	10.0V	10.8V
10 Output Source Current, Purple Wire	0mA	—	10mA
Absolute Voltage Range on 0-10V (+) Purple Wire	-2.0V	—	+15V
Source Current out of 0-10V Purple Wire	0mA	—	2mA

Typical Dimming Circuit

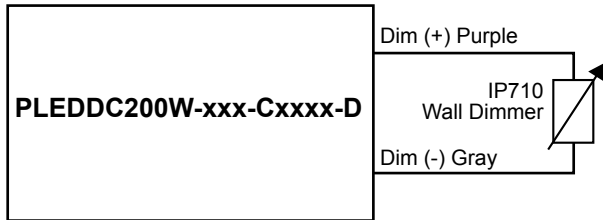

(Dimmer must be current-sink type control)

Output Current / 0-10VDC Dimming Input

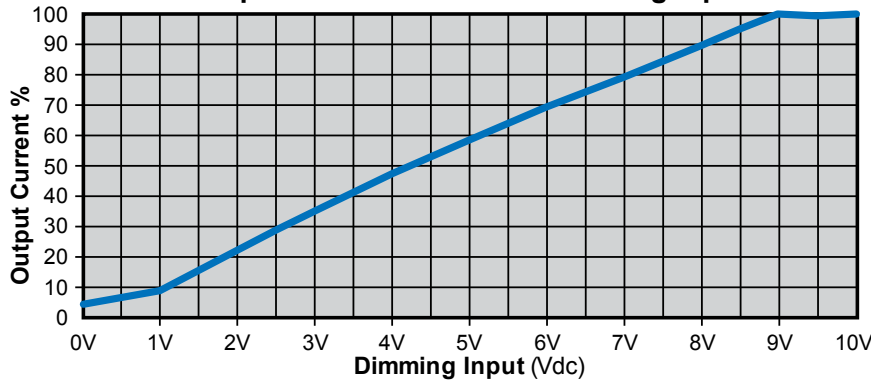

Notes:

1. 0-10V dimmable version comes with an extra two wires +Purple/-Gray on the output side.
2. Compatible with most 0-10V Wall Slide dimmers and direct 0-10V analog signal. Recommended dimmer is Leviton IP710 or equivalent
3. 0-10V dimmable version is not intended to dim to zero (off). Will be lout <10% @ Vdim <1.0V
4. 0-10V dimmable version output will be 100% with Purple/Gray open and minimum with Purple/Gray Shorted.

"-PD" Option: PWM Dimming

Parameters	Minimum	Typical	Maximum
Absolute Maximum Voltage Range on PWM Input (Purple Wire)	-2.0V	10V	+15V
Input LOW Level Voltage Range (Purple Wire)	-2.0	0V	+5.5V
Input HIGH Level Voltage Range (Purple Wire)	+9.0	10V	+15V
Current into PWM Input (Purple Wire)	0mA	—	1.2mA
Source Current out of PWM Input (Purple Wire)	0mA	—	2mA
PWM Input Signal Frequency	500Hz	—	1500Hz
PWM Input Signal Positive Duty Cycle	0%	10-90%	100%

PWM Positive Dimming Typical Circuit

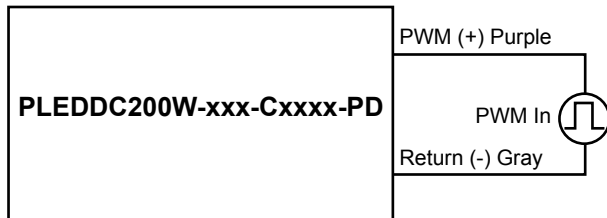

Output Current / 1.0 kHz Positive Duty Cycle

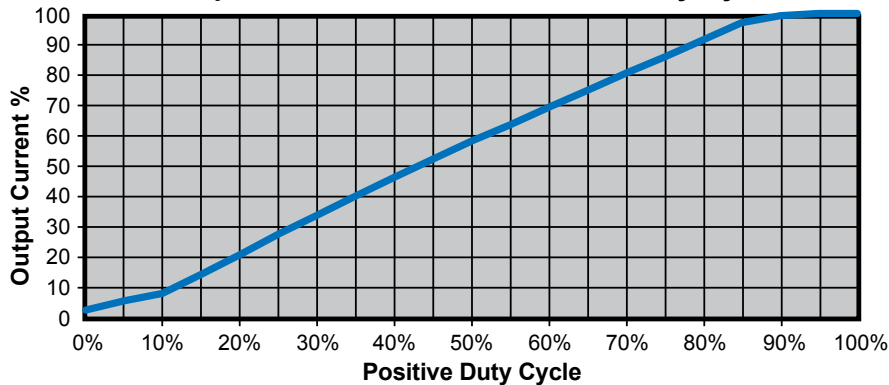

Notes:

1. PWM Dimmable version comes with an extra 2 wires +Purple/-Gray on the output side.
2. Below 10% Duty cycle proper dimming operation is not assured. Unit is not intended to turn off at <10% Duty Cycle.
3. PWM dimmable version output will be 100% with Purple/Gray open and minimum with Purple/Gray Shorted.