

Large Current Positive Voltage Regulator

The KIC3201S/T series are highly precise, low power consumption, positive voltage regulators manufactured using CMOS and laser trimming technologies. The series provides large currents with a significantly small dropout voltage. The KIC3201S/T consists of a driver transistor, a precision reference voltage and an error amplifier. Output voltage is selectable in 0.05V steps between a voltage of 1.2V and 6.0V.

Features

- Maximum Output Current : 400mA
- Dropout Voltage : 150mV @100mA, 300mV @200mA for $V_{OUT}=3.0V$
- Maximum Operating Voltage : 10V
- Output Voltage Range : 1.2V ~ 6.0V (selectable in 0.05V steps)
- Highly Accurate : $\pm 2\%$
- Low Power Consumption : Typ. 8.0uA
- Operational Temperature Range : -40 ~ 85
- Low ESR Capacitor : Ceramic compatible or Tantalum

Applications

- Battery Powered Equipment
- Reference Voltage Sources
- Digital Cameras, Camcoders
- Palmtop Computers
- Portable Audio Video Equipment

Pin Configuration

KIC3201S-XX

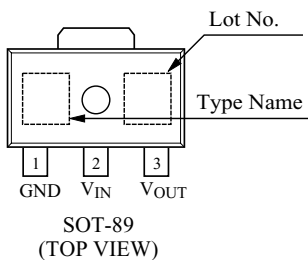

No.	Symbol	Description
1	GND	Ground
2	V_{IN}	Power input
3	V_{OUT}	Output

• Heat Sink is common to (V_{IN})

KIC3201T-XX

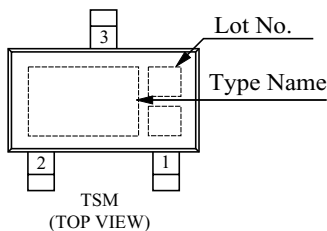

No.	Symbol	Description
1	V_{OUT}	Output
2	GND	Ground
3	V_{IN}	Power input

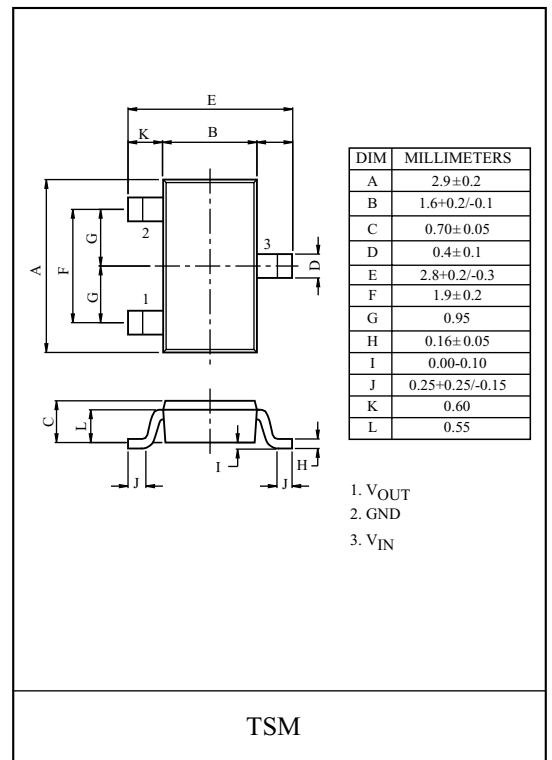
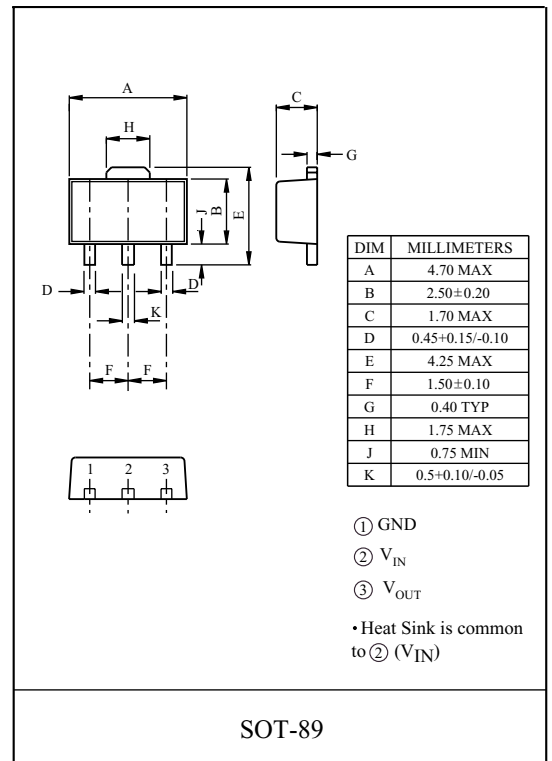

KIC3201S/T-12 ~ KIC3201S/T-60

Line up

V _{OUT(V)}	SOT-89		TSM	
	ITEM	Marking	ITEM	Marking
1.2	KIC3201S-12	A2	KIC3201T-12	B2C
1.3	KIC3201S-13	A3	KIC3201T-13	B3C
1.4	KIC3201S-14	A4	KIC3201T-14	B4C
1.5	KIC3201S-15	A5	KIC3201T-15	B5C
1.6	KIC3201S-16	A6	KIC3201T-16	B6C
1.7	KIC3201S-17	A7	KIC3201T-17	B7C
1.8	KIC3201S-18	A8	KIC3201T-18	B8C
1.9	KIC3201S-19	A9	KIC3201T-19	B9C
2.0	KIC3201S-20	B0	KIC3201T-20	C0C
2.1	KIC3201S-21	B1	KIC3201T-21	C1C
2.2	KIC3201S-22	B2	KIC3201T-22	C2C
2.3	KIC3201S-23	B3	KIC3201T-23	C3C
2.4	KIC3201S-24	B4	KIC3201T-24	C4C
2.5	KIC3201S-25	B5	KIC3201T-25	C5C
2.6	KIC3201S-26	B6	KIC3201T-26	C6C
2.7	KIC3201S-27	B7	KIC3201T-27	C7C
2.8	KIC3201S-28	B8	KIC3201T-28	C8C
2.9	KIC3201S-29	B9	KIC3201T-29	C9C
3.0	KIC3201S-30	C0	KIC3201T-30	D0C
3.1	KIC3201S-31	C1	KIC3201T-31	D1C
3.2	KIC3201S-32	C2	KIC3201T-32	D2C
3.3	KIC3201S-33	C3	KIC3201T-33	D3C
3.4	KIC3201S-34	C4	KIC3201T-34	D4C
3.5	KIC3201S-35	C5	KIC3201T-35	D5C
3.6	KIC3201S-36	C6	KIC3201T-36	D6C
3.7	KIC3201S-37	C7	KIC3201T-37	D7C
3.8	KIC3201S-38	C8	KIC3201T-38	D8C
3.9	KIC3201S-39	C9	KIC3201T-39	D9C
4.0	KIC3201S-40	D0	KIC3201T-40	E0C
4.1	KIC3201S-41	D1	KIC3201T-41	E1C
4.2	KIC3201S-42	D2	KIC3201T-42	E2C
4.3	KIC3201S-43	D3	KIC3201T-43	E3C
4.4	KIC3201S-44	D4	KIC3201T-44	E4C
4.5	KIC3201S-45	D5	KIC3201T-45	E5C
4.6	KIC3201S-46	D6	KIC3201T-46	E6C
4.7	KIC3201S-47	D7	KIC3201T-47	E7C
4.8	KIC3201S-48	D8	KIC3201T-48	E8C
4.9	KIC3201S-49	D9	KIC3201T-49	E9C
5.0	KIC3201S-50	E0	KIC3201T-50	F0C
5.1	KIC3201S-51	E1	KIC3201T-51	F1C
5.2	KIC3201S-52	E2	KIC3201T-52	F2C
5.3	KIC3201S-53	E3	KIC3201T-53	F3C
5.4	KIC3201S-54	E4	KIC3201T-54	F4C
5.5	KIC3201S-55	E5	KIC3201T-55	F5C
5.6	KIC3201S-56	E6	KIC3201T-56	F6C
5.7	KIC3201S-57	E7	KIC3201T-57	F7C
5.8	KIC3201S-58	E8	KIC3201T-58	F8C
5.9	KIC3201S-59	E9	KIC3201T-59	F9C
6.0	KIC3201S-60	F0	KIC3201T-60	G0C

* Other Voltages available, Selectable in 0.05V steps Contact KEC for details.

KIC3201S/T-12 ~ KIC3201S/T-60

Absolute Maximum Ratings

Characteristics	Symbol	Rating	Units
Input Voltage	V_{IN}	12	V
Output Current	I_{OUT}	500	mA
Output Voltage	V_{OUT}	$V_{SS}-0.3 \sim V_{IN}+0.3$	V
Power Dissipation ^(Note)	P_D (SOT-89)	900	mW
	P_D (TSM)		
Operating Temperature	T_{OPR}	-40 ~ 85	
Storage Temperature	T_{STG}	-65 ~ 150	

Note) Package mounted on a ceramic board (600mm² × 0.8mm)

Electrical Characteristics (Unless otherwise stated, $T_a=25^\circ\text{C}$, $V_{IN} = V_{OUT} + 1.0\text{V}$)

Parameter	Symbol	Conditions	Min	Typ	Max	Units	
Input Voltage	V_{IN}		-	-	10	V	
Output Voltage	V_{OUT}	$I_{OUT}=40\text{mA}$, $V_{IN}=V_{OUT} + 1\text{V}$	$V_{OUT} \times 0.98$	V_{OUT}	$V_{OUT} \times 1.02$	V	
Maximum Output Current	$I_{OUT(MAX)}$	$V_{OUT}=1.2\text{V}\sim 1.5\text{V}$	$V_{OUT} \times 0.9$ $V_{IN}=2.5\text{V}$	400	-	-	mA
		$V_{OUT}=1.6\text{V}\sim 2.4\text{V}$	$V_{OUT} \times 0.9$ $V_{IN}=V_{OUT}+1\text{V}$				
		$V_{OUT}=2.5\text{V}\sim 2.9\text{V}$	$V_{OUT} \times 0.93$ $V_{IN}=V_{OUT}+1\text{V}$				
		$V_{OUT}=3.0\text{V}\sim 6.0\text{V}$	$V_{OUT} \times 0.96$ $V_{IN}=V_{OUT}+1\text{V}$				
Load Regulation	Reg Load	1mA I_{OUT} 200mA, $V_{IN}=V_{OUT}+1\text{V}$	-	40	100	mV	
Line Regulation	Reg Line	$V_{OUT} + 1.0\text{V}$ V_{IN} 8V, $I_{OUT}=40\text{mA}$	-	0.2	0.3	%/V	
Dropout Voltage	V_{D1}	$V_{OUT} = 1.2\sim 1.7\text{V}$, $I_{OUT}=100\text{mA}$	-	500	700	mV	
		$V_{OUT} = 1.8\sim 2.4\text{V}$, $I_{OUT}=100\text{mA}$	-	200	300		
		$V_{OUT} = 2.5\sim 2.9\text{V}$, $I_{OUT}=100\text{mA}$	-	170	250		
		$V_{OUT} = 3.0\sim 4.9\text{V}$, $I_{OUT}=100\text{mA}$	-	150	220		
		$V_{OUT} = 5.0\sim 6.0\text{V}$, $I_{OUT}=100\text{mA}$	-	100	180		
	V_{D2}	$V_{OUT} = 1.2\sim 1.7\text{V}$, $I_{OUT}=200\text{mA}$	-	800	1100	mV	
		$V_{OUT} = 1.8\sim 2.4\text{V}$, $I_{OUT}=200\text{mA}$	-	400	600		
		$V_{OUT} = 2.5\sim 2.9\text{V}$, $I_{OUT}=200\text{mA}$	-	320	500		
		$V_{OUT} = 3.0\sim 4.9\text{V}$, $I_{OUT}=200\text{mA}$	-	300	420		
		$V_{OUT} = 5.0\sim 6.0\text{V}$, $I_{OUT}=200\text{mA}$	-	200	320		
Supply Current	I_{DD}	$V_{IN}=V_{OUT(T)}+1\text{V}$	-	8	16	μA	
Output Voltage Temperature Characteristics	$\frac{V_{OUT}}{T_{OPR} \cdot V_{OUT}}$	$I_{OUT}=40\text{mA}$, -40 T_{OPR} 85	-	100	-	ppm/	
Short Circuit Current	I_{SC}	$V_{IN} = V_{OUT}+1\text{V}$, $V_{OUT} = 0\text{V}$	-	50	-	mA	

KIC3201S/T-12 ~ KIC3201S/T-60

Application Circuit

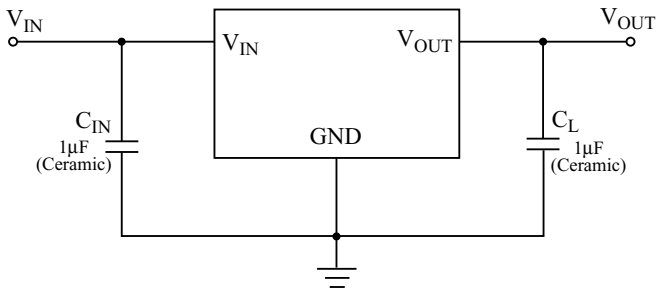

Block Diagram

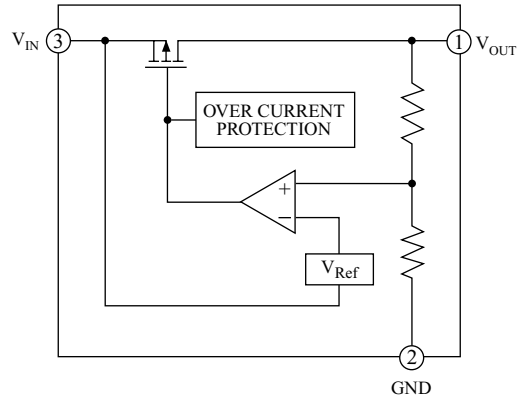

●KIC3201S/T-18

Fig. 1 $I_{OUT} - V_{OUT}$

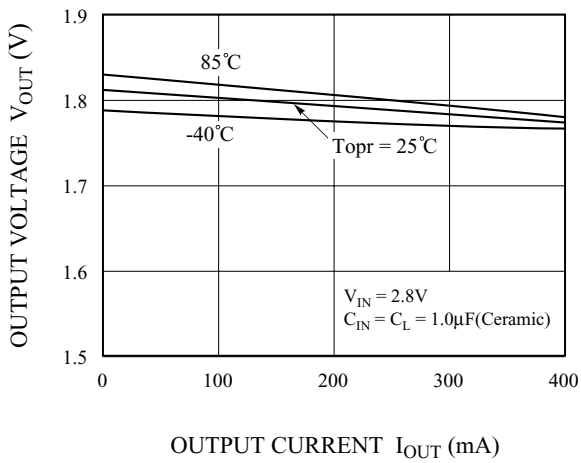

Fig. 2 $V_{IN} - V_{OUT}$

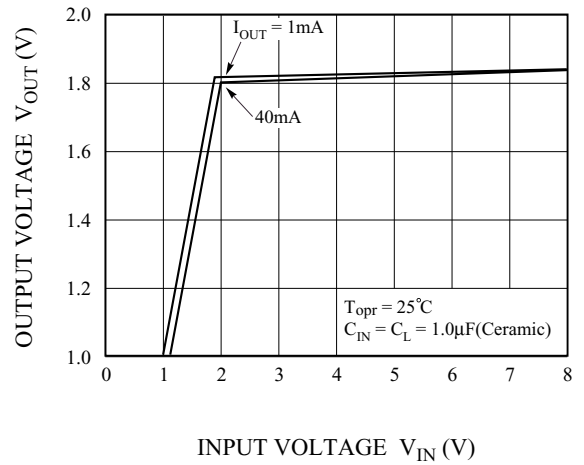

Fig. 3 $V_{IN} - I_{SS}$

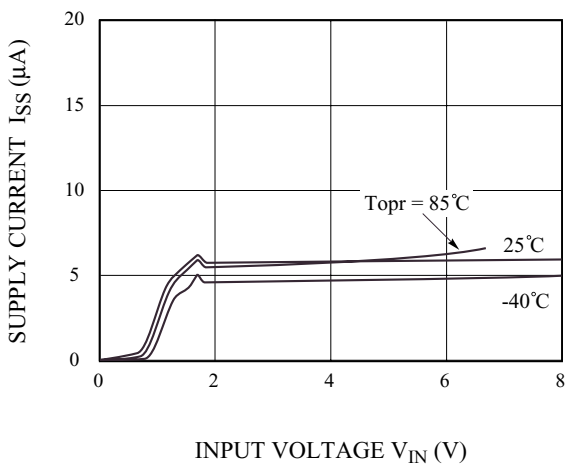
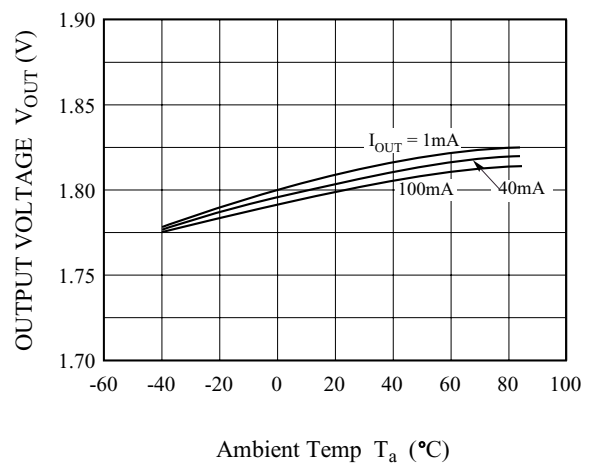

Fig. 4 $T_a - V_{OUT}$



KIC3201S/T-12 ~ KIC3201S/T-60

Fig. 5 Input Transient Response

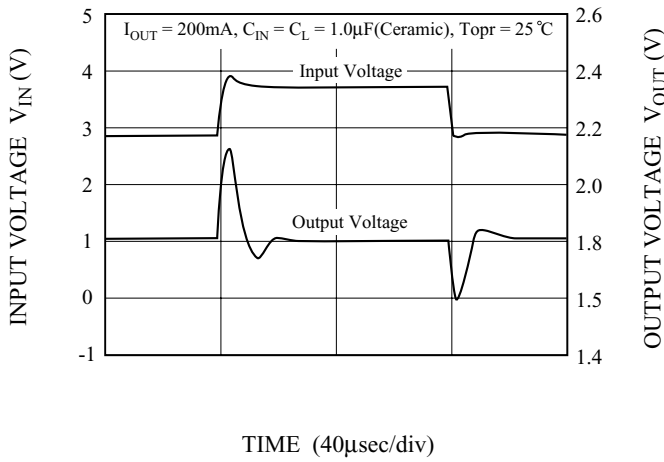

Fig. 6 Load Transient Response ($I_{OUT} = 40\text{mA}$)

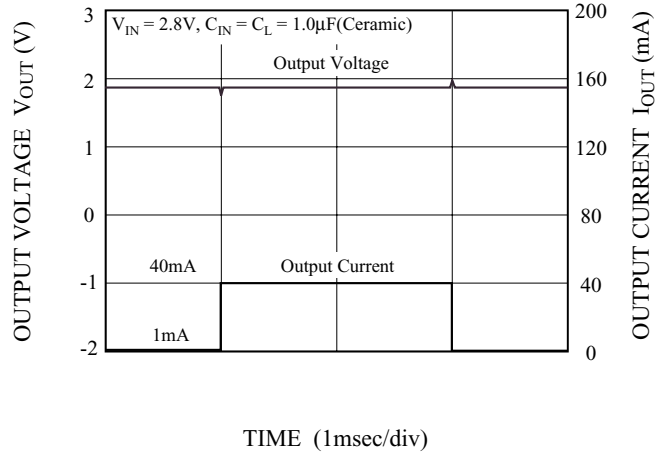

Fig. 7 Load Transient Response ($I_{OUT} = 200\text{mA}$)

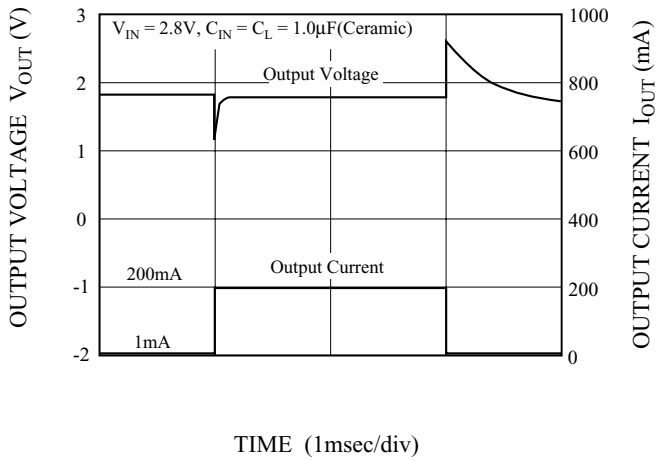

Fig. 8 PSRR

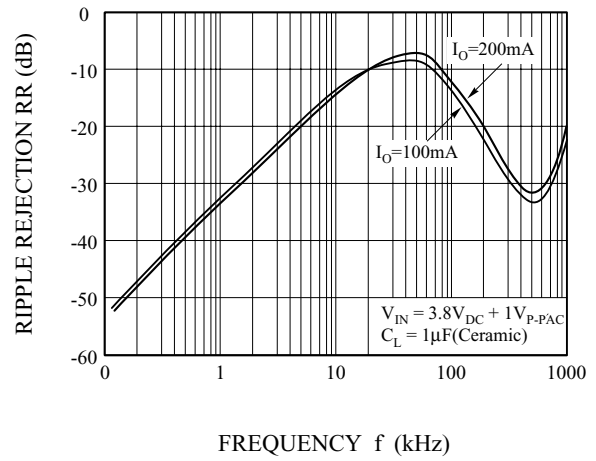

Fig. 9 $I_{OUT} - V_{DROP}$

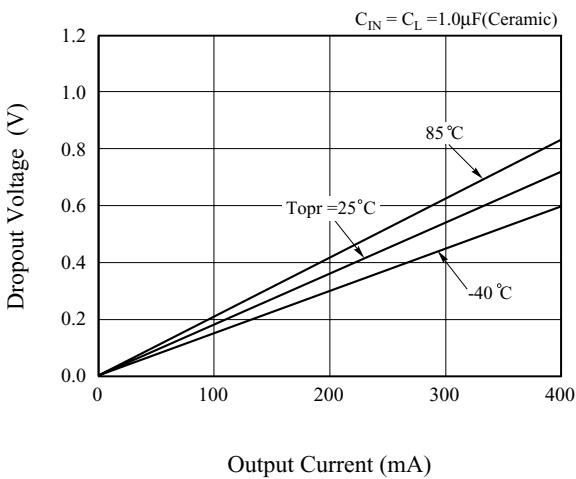

Fig.10 $P_D - T_a$

