

1

2

3

4

5

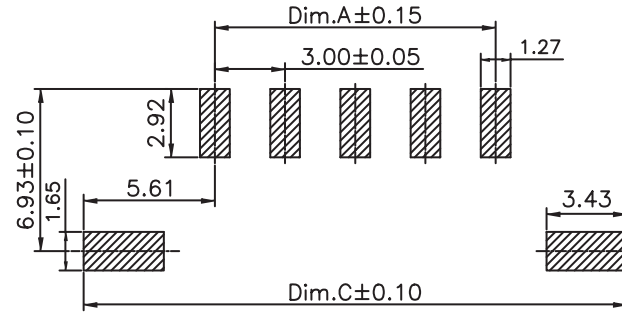

PCB LAYOUT - COMPONENT VIEW

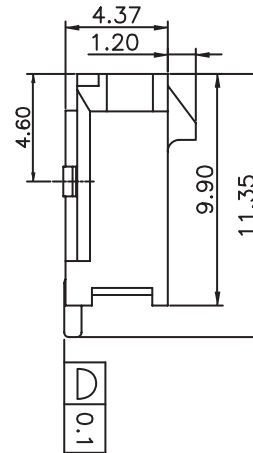
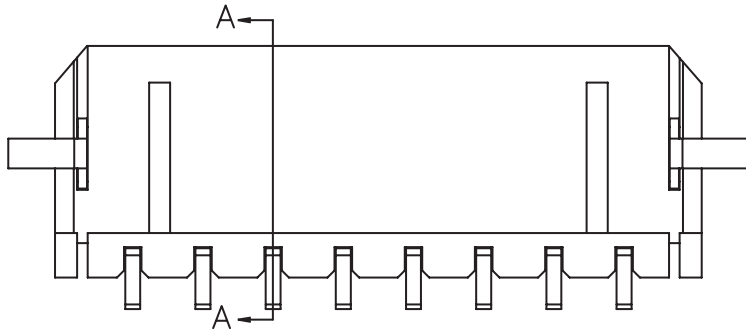
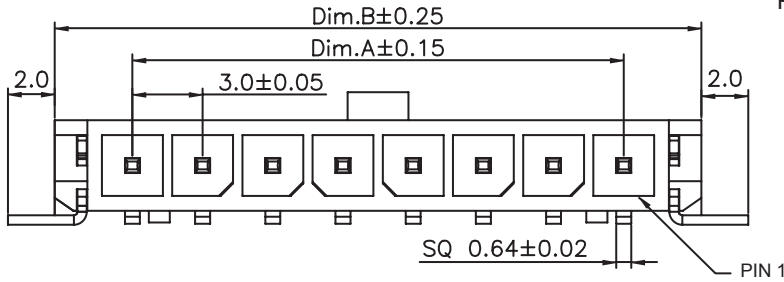

TECHNICAL CHARACTERISTICS

MATERIAL
 INSULATOR: LCP
 FLAMABILITY RATING: UL94-V0
 COLOR: BLACK
 CONTACT MATERIAL: COPPER ALLOY
 CONTACT TYPE: STAMPED
 CONTACT PLATING: TIN
 QUALITY CLASS: 25 MATING CYCLES
 PITCH: 3.00MM

ENVIRONMENTAL
 OPERATING TEMPERATURE: -40 UP TO 105°C
 COMPLIANCE: LEAD FREE AND ROHS

ELECTRICAL
 CURRENT RATING: 5A
 WORKING VOLTAGE: 250V AC
 INSULATOR RESISTANCE: >1000 MOHM
 DIELECTRIC WITHSTANDING VOLTAGE: 1500V AC/MN
 CONTACT RESISTANCE: 10 mOHM MAX

STANDARD
 CERTIFIED: E323964

SOLDERING
 JEDEC LEAD FREE REFLOW PROCESS

PACKAGING
 TAPE & REEL

DIMENSION
 A = 3.00 x (NB. PIN - 1)
 B = 3.00 x (NB. PIN) + 3.65
 C = 3.00 x (NB. PIN) + 8.20

RoHS Compliant

G	29-JUL-13	DWG & CARAC	QL
F	06-JUL-12	PLASTIC	GG
E	22-FEB-12	DESCRIPTION	GG
D	17-NOV-10	PINNING	GG
C	18-NOV-09	STANDARD	JP
B	23-AVR-09	PACKAGING	JC
A	05-MAR-09	PDF	JP
REV	DATE	FILE	BY

PROJECTION:

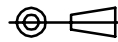

APPROVAL: RJ

GENERAL TOLERANCE

.X = +/- 0.2

.XX = +/- 0.15

UNIT: MM

SCALE:

SHEET: 1/2

DRAW: MIKE



DESCRIPTION: 3.00MM SMD MALE SINGLE ROW ANGLED HEADER SMT
 SOLDER TAB

WERI PART NO: 662 1xx 145 021

SIZE

A4

A

B

C

D

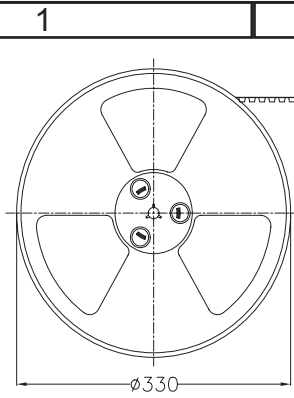

PULL OUT DIRECTION

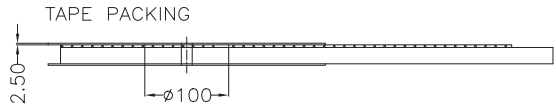

TAPE PACKING

2.50

∅100

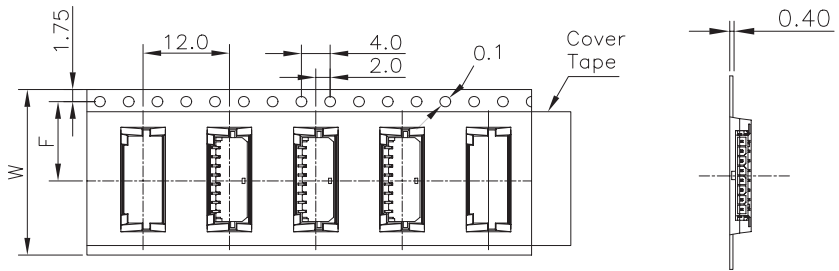

For Reel width (dimension W) 16,24mm
Single row hole

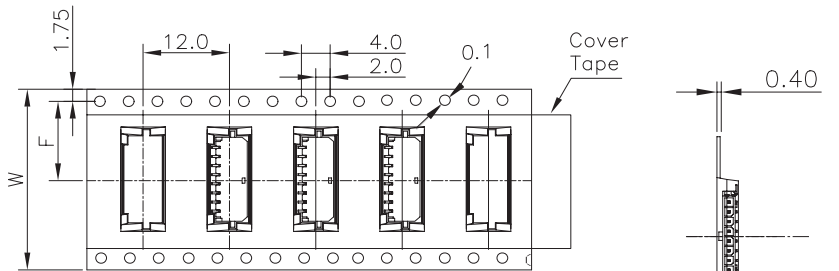

For Reel width (dimension W) 32,44,56,72mm
Double rows hole

- Note:
- All dimensions meet EIA-481-3 requirements.
 - Material : BK Conductive Polystyrene Alloy
100% recyclable.
 - Thickness : 0.50±0.05mm
 - Component load per 13" reel :400 pcs.
 - Carton Size:350*350*296(mm)
 - Need Vacuum Pack

Pin.	W	F	Pcs/R	R/Carton	Pcs/Carton
2	24	11.5	400	8	3200
3	32	14.2	400	6	2400
4	32	14.2	400	6	2400
5	44	20.2	400	5	2000
6	44	20.2	400	5	2000
7	44	20.2	400	5	2000
8	44	20.2	400	5	2000
9	56	26.2	400	3	1200
10	56	26.2	400	3	1200
11	56	26.2	400	3	1200
12	56	26.2	400	3	1200

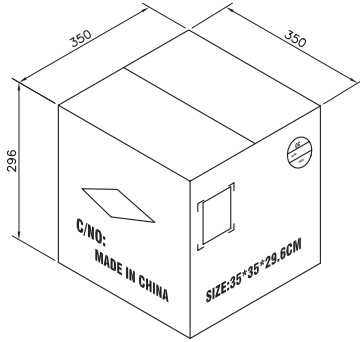

RoHS Compliant			
G			
F			
E			
D			
C			
B			
A			
REV	DATE	FILE	BY

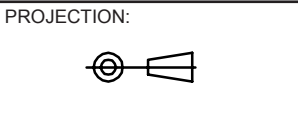

GENERAL TOLERANCE
.X = +/- 0.2
.XX = +/- 0.15

APPROVAL: RJ

UNIT: MM
SCALE:
SHEET: 2/2
DRAW: PEARL



DESCRIPTION: 3.00MM SMD MALE SINGLE ROW ANGLED HEADER - SMT SOLDER TAB
WERI PART NO: 6621 xx 145021_TPK

SIZE
A4