



PRODUCT SPECIFICATION

Part Number

PT322435-TLMWD-E23B

CUSTOMER	
CUSTOMER PART NUMBER	
DESCRIPTION	
APPROVED BY	
DATE	

**1. Table of Contents**

No.	Contents	Page
1	Table of Contents	2
2	Record of Revisions	3
3	Module Numbering System	4
4	Application	5
5	Features	5
6	General Specifications	5
7	Absolute Maximum Ratings	6
8	Electrical Characteristics	7
9	Block Diagram	10
10	Input / Output Terminals Pin Assignment	11
11	Interface Timing	13
12	Instruction Description	17
13	Optical Characteristics	18
14	Reliability Test	21
15	Packaging	22
16	Precautions	23
17	Outline Drawing	26
18	Definition of Labels	27
19	Incoming Inspection Standards	29



3. Module Numbering System

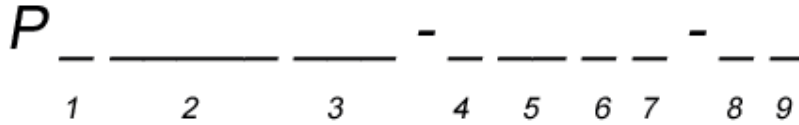

1. LCD TYPE

C = Character
G = Graphic
T = TFT
COG = Chip on Glass
COF = Chip on Flex
TAB = Tape Automated Bonding

2. LENGTH x WIDTH

in pixels. Zeroes removed from this section.

3. DIAGONAL DIMENSION

Product size in inches

4. LCD MODE

T = TN

5. POLARIZER

LF = Transflective
LM = Transmissive

6. BACKLIGHT COLOR

B = Blue
Y = Yellow
G = Green
S = Yellow-Green
W = White

7. VIEWING DIRECTION

D = 6 o'clock
U = 12 o'clock
F = Full v/a

8. A ~ Z CODE

Assigned by P-tec

9. TOUCH PANEL TYPE

None = Blank
R = Resistive
C = Capacitive

10. SPECIAL CHARACTERS

Characters assigned by P-tec to reflect special customer requirements

**4. Application**

This specification is applied to the 3.5 inch QVGA supported TFT-LCD module With Transparent Touch Panel, and can display 262k colors. The module is designed for PMP, GPS, DMB, other electronic products which require flat panel display of digital signal interface, and used as the input devices for general electric appliances via both finger and pen-entry.

5. Features

- QVGA (320×240 pixels) resolution.
- CCIR656 data format (640RGB & 720RGB).
- Serial Peripheral Interface (SPI).
- Line inversion mode with stripe type.
- On-chip voltage generator
- Transparent Touch panel
 - 4-Wire
 - Analog Resistive
 - Chemical Strengthen

6. General Specifications

Item	Specifications	Unit
Screen Size	3.5 (Diagonal)	inch
Display Format	320RGB(H)×240(V)	dot
Active Area	70.08(H)×52.56(V)	mm
Dot Pitch	0.073(H)×0.219(V)	mm
Pixel Configuration	RGB Vertical Stripe	-
Display Mode	TN Type Transmissive Mode Normally White	-
Surface Treatment	Anti-Glare and Hard Coating(3H)	-
Viewing Direction	6 O'clock (The Gray Inversion will appear at this direction)	-
Outline Dimension	76.9(W)×63.9(H)×4.4(D)	mm
DC to DC circuit	Build-in	-
Weight	(42)	g
RoHS Compliance	P-tec certifies this product to be in compliance with European Union Directive 2002/95/EC on the restriction of certain hazardous substances in electrical and electronic equipment.	-

**7. Absolute Maximum Ratings****7.1 Absolute Ratings of Environment**

Item	Symbol	Value		Unit	Note
		Min.	Max.		
Storage Temperature	T _{ST}	-30	+80	°C	(1)(2)
Operating Temperature	T _{OP}	-20	+70	°C	(1)(2)

Note1: Background color changes slightly depending on ambient temperature.

This phenomenon is reversible.

Note2: Please refer to item of RELIABILITY.

7.2 Electrical Absolute Ratings**7.2.1 TFT-LCD Module**

(Ta=25±2°C, GND=V_{SS}=0V)

Item	Symbol	Value		Unit	Note
		Min.	Max.		
Digital Power Supply Voltage	V _{CC}	V _{SS} -0.3	5.0	V	-

7.2.2 Backlight Unit

(Ta=25±2°C)

Item	Symbol	Value		Unit	Note
		Min.	Max.		
Forward current	I _f	-	(30)	mA	(1)
Reverse voltage	V _r	-	(30)	V	(1)

Note (1) Permanent damage to the device may occur if maximum values are exceeded or reverse voltage is loaded.



8. Electrical Characteristics

8.1 TFT-LCD Module

(Ta=25±2°C)

Item	Symbol	Value			Unit	Note
		Min.	Typ.	Max.		
Digital Power Supply Voltage	V _{CC}	2.5	3.3	3.6	V	-
Input High Threshold Voltage	V _{IH}	0.8V _{CC}	-	V _{CC}	V	-
Input Low Threshold Voltage	V _{IL}	0	-	0.2V _{CC}	V	-

(GND=V_{SS}=0V)

Parameter	SYMBOL	Condition	Min	Typ	Max	Unit	Remarks
Digital Current	I _{vcc}	V _{CC} = 3.3V	-	15.6	22.0	mA	(1)
Total Power Consumption	PC	-	-	51.48	72.6	mW	(1)

Note (1) The specified power consumption is under the conditions at V_{CC}=3.3V, F_V=60Hz, whereas a power dissipation check pattern below is displayed.

Black Pattern / 0 Gray

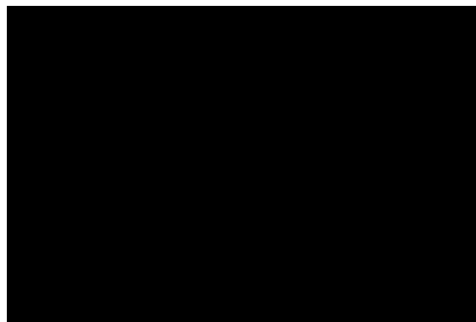

Active Area

**8.2 Backlight Unit**

(Ta=25±2°C)

Item	Symbol	Value			Unit	Note
		Min.	Typ.	Max.		
LED Voltage	VL	-	(19.5)	-	V	(1)
LED Current	IL	-	(20)	-	mA	(1)
Power Consumption	P _{BL}	-	(390)	-	mW	(1)

Note (1) The driving design of backlight unit is dependent on serial consideration of six LEDs.

8.3 Transparent Touch panel

Item		Value			Unit	Note
		Min.	Typ.	Max.		
Operating Voltage		-	5	7	V	-
Terminal Resistance	X-direction	300	-	900	Ω	At connector
	Y-direction	300	-	700	Ω	At connector
Insulation Resistance		≥ 20MΩ				at DC25V
Chatting		≤ 10 ms				-
Linearity		≤ 1.5%				(1)

Note(1): Measurement condition of Linearity



Linearity Definition

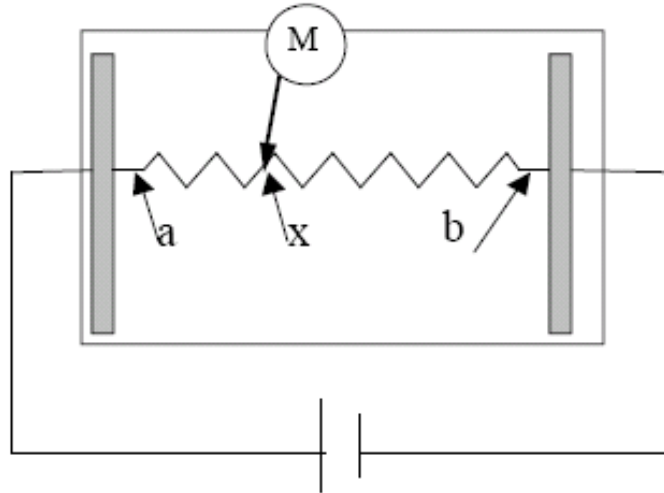

Va : maximum voltage in the active area of touch panel

Vb: minimum voltage in the active area of touch panel

X : random measuring point

Vxm: Actual voltage of Lx point

Vxi : Theoretical voltage of Lx point

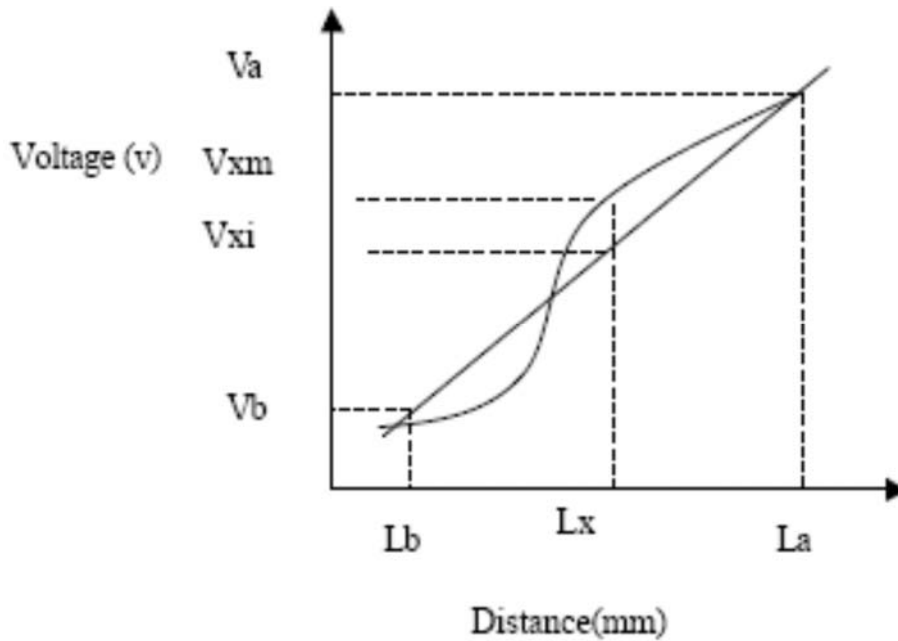

$$\text{Linearity} : \left[\frac{1}{2}V_{xi} - V_{xm} \right] / (V_a - V_b) * 100\%$$



9. Block Diagram

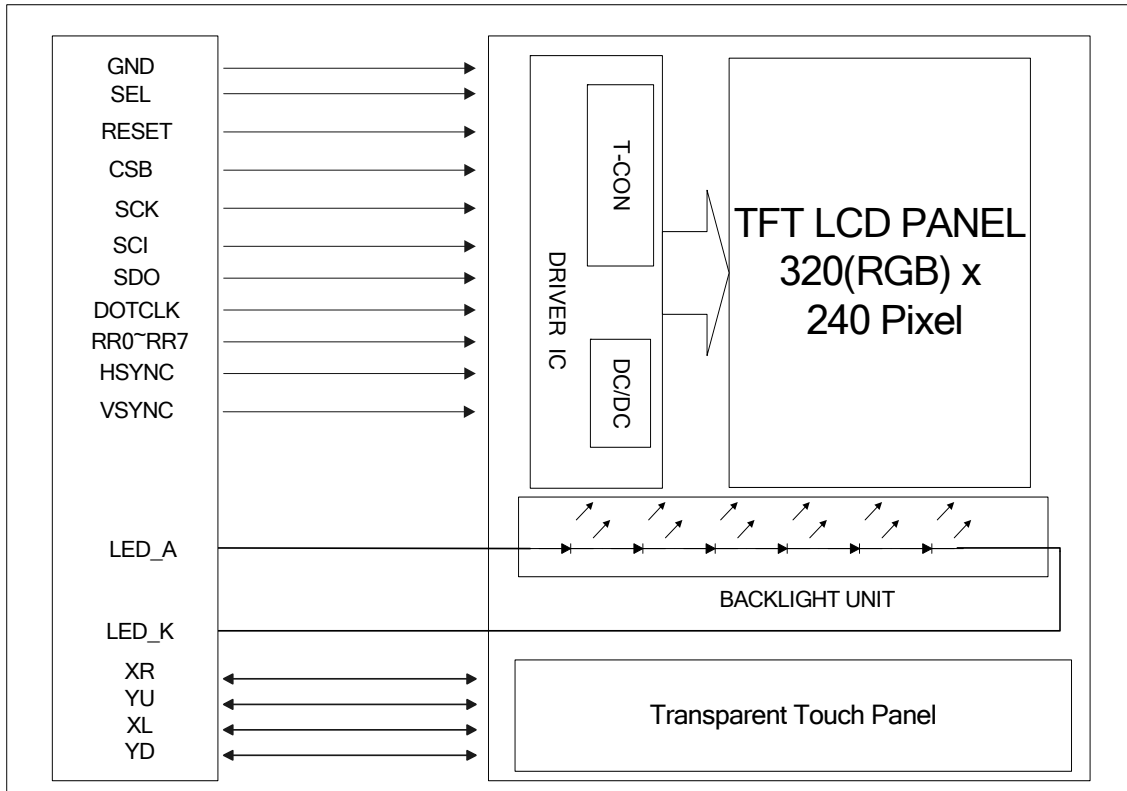

**10. Input / Output Terminals Pin Assignment****10.1 TFT-LCD Module**

Pin No.	Symbol	I/O	Description	
1	LED_K	I	LED_cathode	
2	LED_K	I	LED_cathode	
3	LED_A	I	LED_anode	
4	LED_A	I	LED_anode	
5	GND	I	Ground	
6	X1	I	RIGHT	
7	Y1	I	TOP	
8	X2	I	LEFT	
9	Y2	I	BOTTOM	
10	GND	I	Ground	
11	SEL	I	Pin11	Define the input interface mode.
			Pull High	CCIR 656 data format (720RGB)
			Pull Low & NC	CCIR 656 data format (640RGB)
12	NC	I	No connection	
13	NC	I	No connection	
14	RESET	I	Reset	
15	CSB	I	CHIP SELECT	
16	SCK	I	Serial Clock	
17	SDI	I	Serial Data Input	
18	TEST	I	No connection	
19	TEST	I	No connection	
20	TEST	I	No connection	
21	TEST	I	No connection	
22	TEST	I	No connection	
23	TEST	I	No connection	
24	TEST	I	No connection	
25	TEST	I	No connection	
26	TEST	I	No connection	
27	TEST	I	No connection	
28	TEST	I	No connection	
29	TEST	I	No connection	
30	TEST	I	No connection	



Pin No.	Symbol	I/O	Description
31	TEST	I	No connection
32	TEST	I	No connection
33	TEST	I	No connection
34	RR0	I	Data 0(LSB)
35	RR1	I	CCIR656 input data
36	RR2	I	
37	RR3	I	
38	RR4	I	
39	RR5	I	
40	RR6	I	
41	RR7	I	
42	HSYNC	I	Horizontal synchronous signal
43	VSYNC	I	Vertical synchronous signal
44	DOTCLK	I	Data Colck
45	NC	I	No connection
46	NC	I	No connection
47	VCC	I	Digital Power
48	VCC	I	Digital Power
49	SDO	I	Serial Data Output
50	NC	I	No connection
51	NC	I	No connection
52	NC	I	No connection
53	NC	I	No connection
54	NC	I	No connection
55	NC	I	No connection
56	NC	I	No connection
57	NC	I	No connection
58	TEST	I	No connection
59	GND	I	Ground
60	GND	I	Ground



11. Interface Timing

11.1 Input Signal Characteristics

11.1.1 CCIR 656 data format (640RGB)

PARAMETER	SYMBOL	MIN.	TYP.	MAX.	UNIT
CLK frequency	F _{osc}	-	24.54	-	Mhz
CLK period	T _{osc}	-	40.7	-	ns
Data setup time	T _{SU}	12	-	-	ns
Data hold time	T _{HD}	12	-	-	ns

11.1.2 CCIR 656 data format (720RGB)

PARAMETER	SYMBOL	MIN.	TYP.	MAX.	UNIT
CLK frequency	F _{osc}	-	27	-	Mhz
CLK period	T _{osc}	-	37	-	ns
Data setup time	T _{SU}	12	-	-	ns
Data hold time	T _{HD}	12	-	-	ns

11.1.3 SPI Interface

Characteristics	Symbol	Min.	Typ.	Max.	Unit
Serial Clock Frequency	fclk	-	-	20	MHZ
Serial Clock Cycle Time	tclk	50	-	-	ns
Clock Low Width	tsl	25	-	-	ns
Clock High Width	tsh	25	-	-	ns
Clock Rising Time	trs	-	-	30	ns
Clock Falling Time	tfl	-	-	30	ns
Chip Select Setup Time	tcss	0	-	-	ns
Chip Select Hold Time	tcsh	10	-	-	ns
Chip Select High Delay Time	tcsd	20	-	-	ns
Data Setup Time	tds	5	-	-	ns
Data Hold Time	tdh	10	-	-	ns

11.2 Waveform

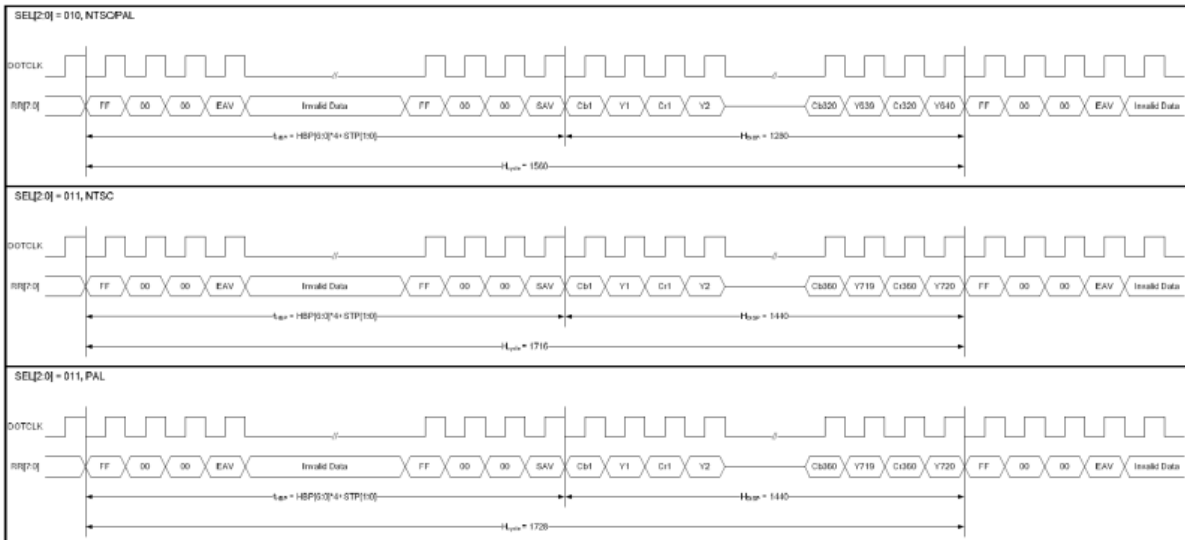

CCIR656 Horizontal Timing



SEL[2:0] = 010, 011, NTSC (F=0 à ODD field, F=1 à EVEN field)



SEL[2:0] = 010, 011, PAL, PALM=0 (F=0 à ODD field, F=1 à EVEN field)

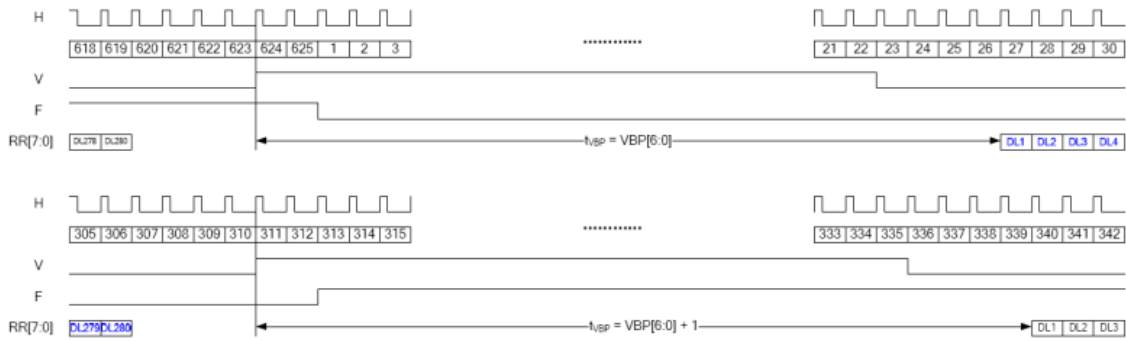

SEL[2:0] = 010, 011, PAL, PALM=1 (F=0 à ODD field, F=1 à EVEN field)

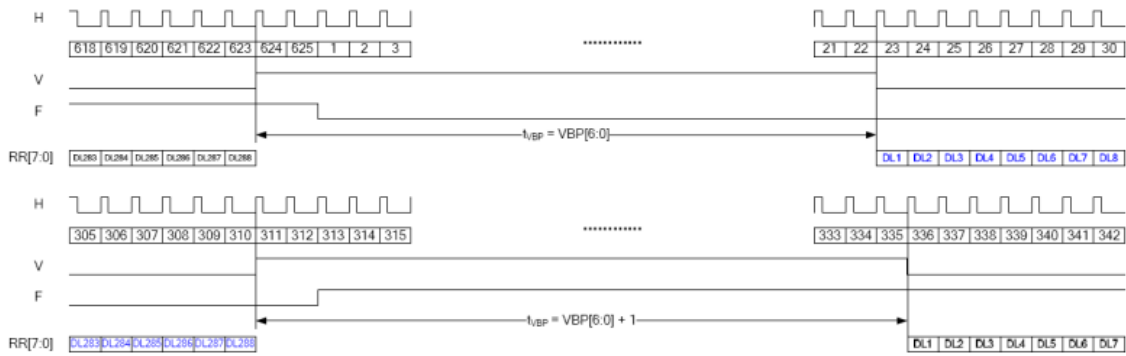

CCIR656 Vertical Timing



11.3 SPI

R/S	R/W	status
0	0	Write SPI address
1	0	Write SPI data
1	1	Read SPI data

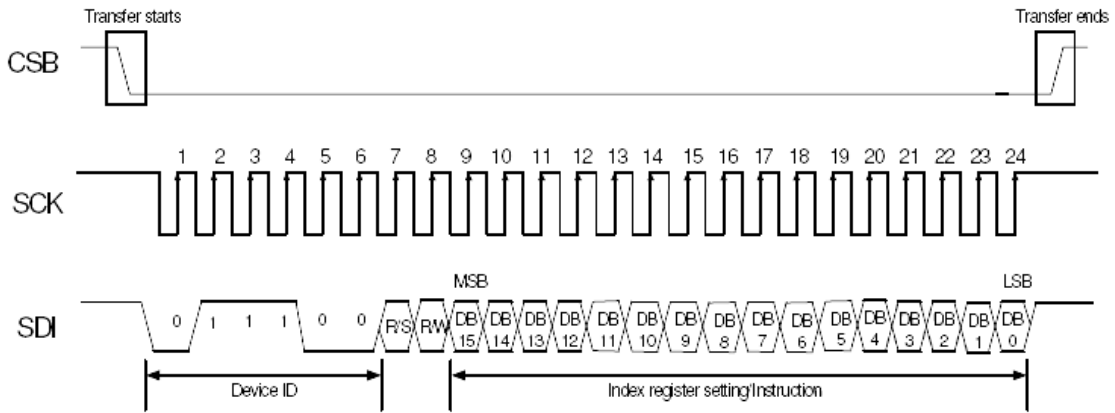

First Transmission (Register)

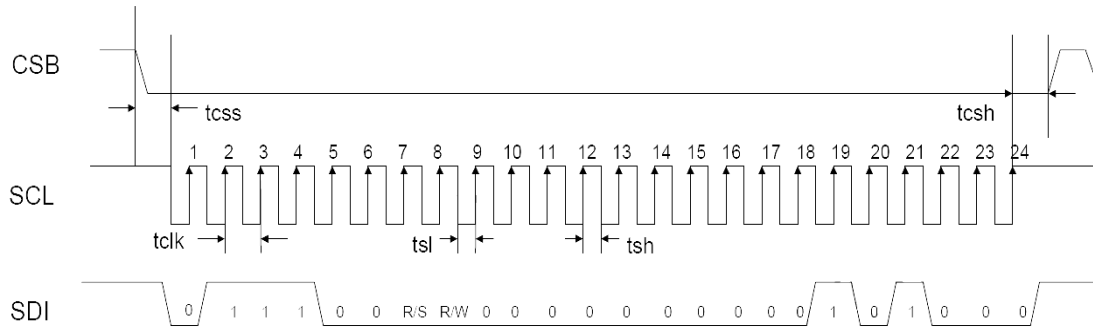

Second Transmission (Data)

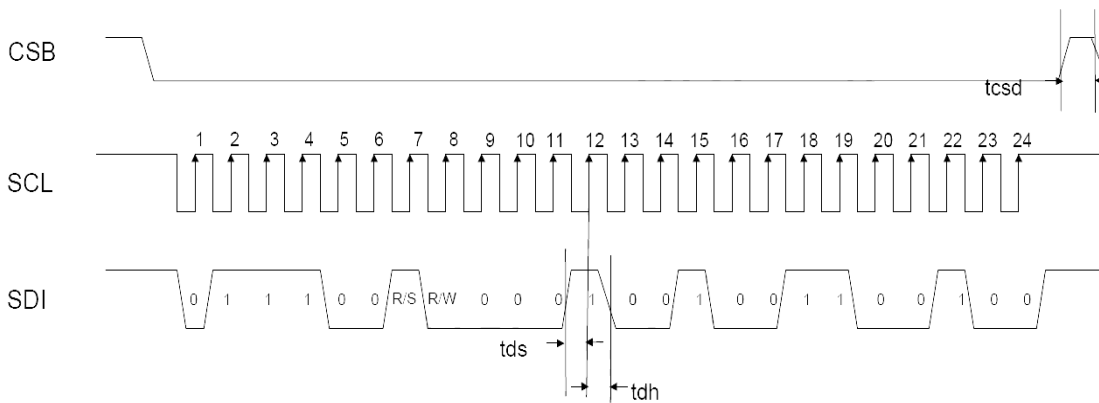



11.4 Power On / Off Sequence

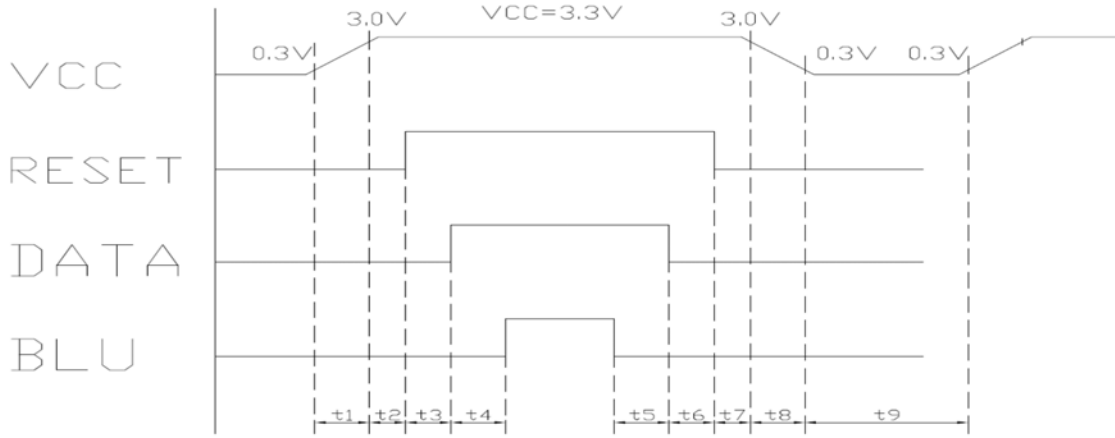

- | | | |
|-------------------|-------------------|-------------------------|
| $T1 \leq 10ms$ | $200ms \leq T5$ | $1 \text{ sec} \leq T9$ |
| $10\mu s \leq T2$ | $50ms \leq T6$ | |
| $50ms \leq T3$ | $10\mu s \leq T7$ | |
| $200ms \leq T4$ | $T8 \leq 10ms$ | |



12. Instruction Description
SPI Command Table

Reg#	Register	R/W	R/S	IB15	IB14	IB13	IB12	IB11	IB10	IB9	IB8	IB7	IB6	IB5	IB4	IB3	IB2	IB1	IB0	
SR	Status Read	1	0	L7	L6	L5	L4	L3	L2	L1	L0	0	0	0	0	0	0	0	0	
R01h	Driver output control	0	1	0	RL	REV	PINV	BGR	SM	TB	CPE	0	0	0	0	0	0	0	0	
R02h	LCD driver AC control	0	1	0	0	0	0	0	0	B/C	0	0	0	0	0	0	0	0	0	
R03h	Power control (1)	0	1	DCT3	DCT2	DCT1	DCT0	BTF	BT2	BT1	BT0	DC3	DC2	DC1	DC0	AP2	AP1	AP0	0	
R04h	Data and color filter control	0	1	0	0	0	0	0	PALM	BLT1	BLT0	OEA1	OEA0	SEL2	SEL1	SEL0	SWD2	SWD1	SWD0	
R05h	Function control	0	1	GHN	XDK	GDIS	LPF	DEP	CKP	VSP	HSP	DEO	DIT	0	PWM	0	FB2	FB1	FB0	
R06h	Reserved	Reserved																		
R07h	Reserved	Reserved																		
R0Ah	Contrast/Brightness control	0	1	0	BR6	BR5	BR4	BR3	BR2	BR1	BR0	0	0	0	CON4	CON3	CON2	CON1	CON0	
R0Bh	Frame cycle control	0	1	NO1	NO0	SDT1	SDT0	0	EQ2	EQ1	EQ0	0	0	0	0	0	0	0	0	
R0Dh	Power control (2)	0	1	0	VRC2	VRC1	VRC0	0	0	VDS1	VDS0	0	0	VRH5	VRH4	VRH3	VRH2	VRH1	VRH0	
R0Eh	Power control (3)	0	1	0	0	1	VDV6	VDV5	VDV4	VDV3	VDV2	VDV1	VDV0	0	0	0	0	0	0	
R0Fh	Gate scan starting Position	0	1	0	0	0	0	0	0	0	0	SCN7	SCN6	SCN5	SCN4	SCN3	SCN2	SCN1	SCN0	
R16h	Horizontal Porch	0	1	XLIM8	XLIM7	XLIM6	XLIM5	XLIM4	XLIM3	XLIM2	XLIM1	XLIM0	0	0	0	0	0	0	0	
R17h	Vertical Porch	0	1	STH1	STH0	HBP6	HBP5	HBP4	HBP3	HBP2	HBP1	HBP0	VBP6	VBP5	VBP4	VBP3	VBP2	VBP1	VBP0	
R1Eh	Power control (4)	0	1	0	0	0	0	0	0	0	0	nOTP	VCM6	VCM5	VCM4	VCM3	VCM2	VCM1	VCM0	
R27h	Reserved	Reserved																		
R28h	Reserved	Reserved																		
R29h	Reserved	Reserved																		
R2Bh	Reserved	Reserved																		
R30h	γ control (1)	0	1	0	0	0	0	0	PKP 12	PKP 11	PKP 10	0	0	0	0	0	PKP 02	PKP 01	PKP 00	
R31h	γ control (2)	0	1	0	0	0	0	0	PKP 32	PKP 31	PKP 30	0	0	0	0	0	PKP 22	PKP 21	PKP 20	
R32h	γ control (3)	0	1	0	0	0	0	0	PKP 52	PKP 51	PKP 50	0	0	0	0	0	PKP 42	PKP 41	PKP 40	
R33h	γ control (4)	0	1	0	0	0	0	0	PRP 12	PRP 11	PRP 10	0	0	0	0	0	PRP 02	PRP 01	PRP 00	
R34h	γ control (5)	0	1	0	0	0	0	0	PKN 12	PKN 11	PKN 10	0	0	0	0	0	PKN 02	PKN 01	PKN 00	
R35h	γ control (6)	0	1	0	0	0	0	0	PKN 32	PKN 31	PKN 30	0	0	0	0	0	PKN 22	PKN 21	PKN 20	
R36h	γ control (7)	0	1	0	0	0	0	0	PKN 52	PKN 51	PKN 50	0	0	0	0	0	PKN 42	PKN 41	PKN 40	
R37h	γ control (8)	0	1	0	0	0	0	0	PRN 12	PRN 11	PRN 10	0	0	0	0	0	PRN 02	PRN 01	PRN 00	
R3Ah	γ control (9)	0	1	0	0	0	VRP 14	VRP 13	VRP 12	VRP 11	VRP 10	0	0	0	0	0	VRP 03	VRP 02	VRP 01	VRP 00
R3Bh	γ control (10)	0	1	0	0	0	VRN 14	VRN 13	VRN 12	VRN 11	VRN 10	0	0	0	0	0	VRN 03	VRN 02	VRN 01	VRN 00

Note: * means don't care



13. Optical Characteristics

The optical characteristics should be measured in a dark environment (≤ 1 lux) or equivalent state with the methods shown in Note (5).

Item		Symbol	Conditions	Min.	Typ.	Max.	Unit	Note
Contrast Ratio		CR	$\theta_x=0^\circ, \theta_y=0^\circ$ Viewing Normal Angle	150	(350)	-	-	(2),(5)
Response Time		T_{R+T_F}		-	50	-	ms	(3)
Luminance(Center)		Y		250	(350)	-	cd/m ²	(4),(5)
Brightness uniformity		BUNI		80	-	-	%	(5),(6)
Color Chromaticity	Red	R _x		0.566	0.616	0.666	(1),(5)	(1),(4)
		R _y		0.293	0.343	0.393	-	
	Green	G _x		0.254	0.305	0.354	-	
		G _y		0.547	0.597	0.647	-	
	Blue	B _x		0.088	0.138	0.188	-	
		B _y		0.045	0.095	0.145	-	
	White	W _x	0.247	0.297	0.347	-		
		W _y	0.292	0.342	0.392	-		
Viewing Angle	Horizontal	θ_{x+}	55	(70)	-	deg.		
		θ_{x-}	55	(70)	-			
	Vertical	θ_{y+}	40	(55)	-			
		θ_{y-}	50	(70)	-			



Note (1) Definition of Viewing Angle (θ_x, θ_y):

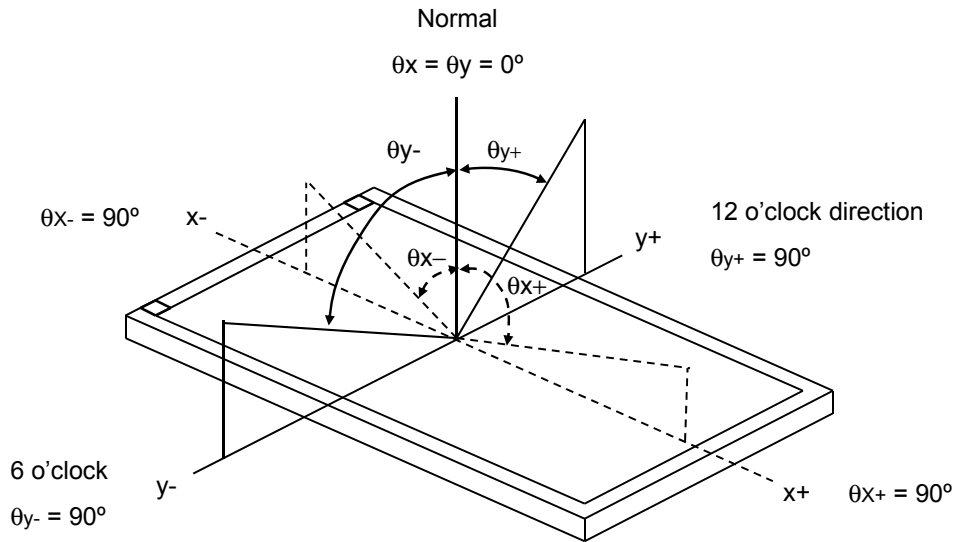

Note (2) Definition of Contrast Ratio (CR):

$$CR = \frac{\text{Luminance (brightness) all pixels "White"}}{\text{Luminance (brightness) all pixels "dark"}}$$

Note (3) Definition of Response Time (T_R, T_F):

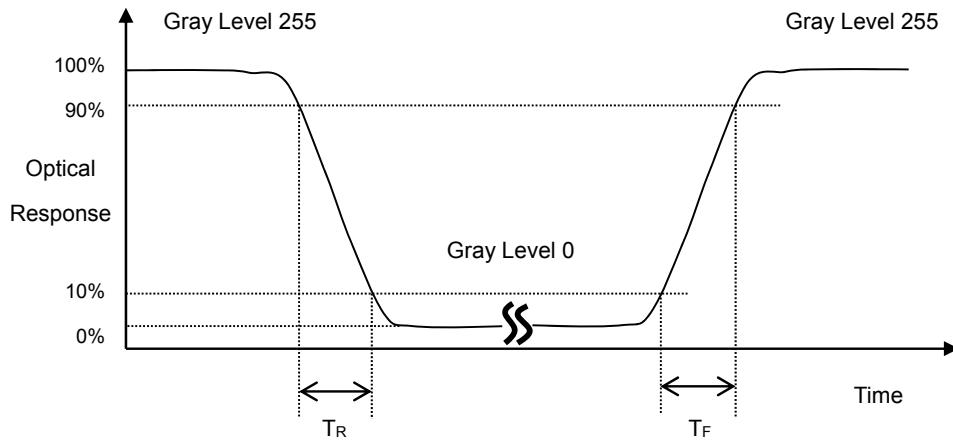



Note (4) Measurement Set-Up:

The LCD module should be stabilized at a given temperature for 30 minutes to avoid abrupt temperature change during measuring. In order to stabilize the luminance, the measurement should be executed after lighting Backlight for 30 minutes in a windless room.

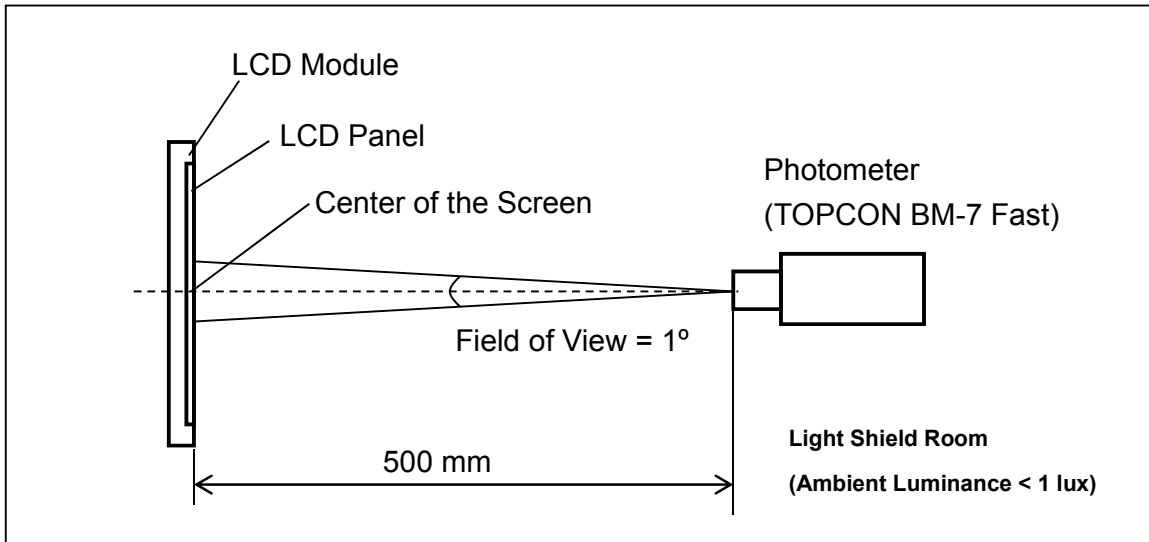

Note (5) Definition of brightness uniformity

$$\text{Brightness uniformity} = (\text{Min Luminance of 9 points}) / (\text{Max Luminance of 9 points}) \times 100\%$$

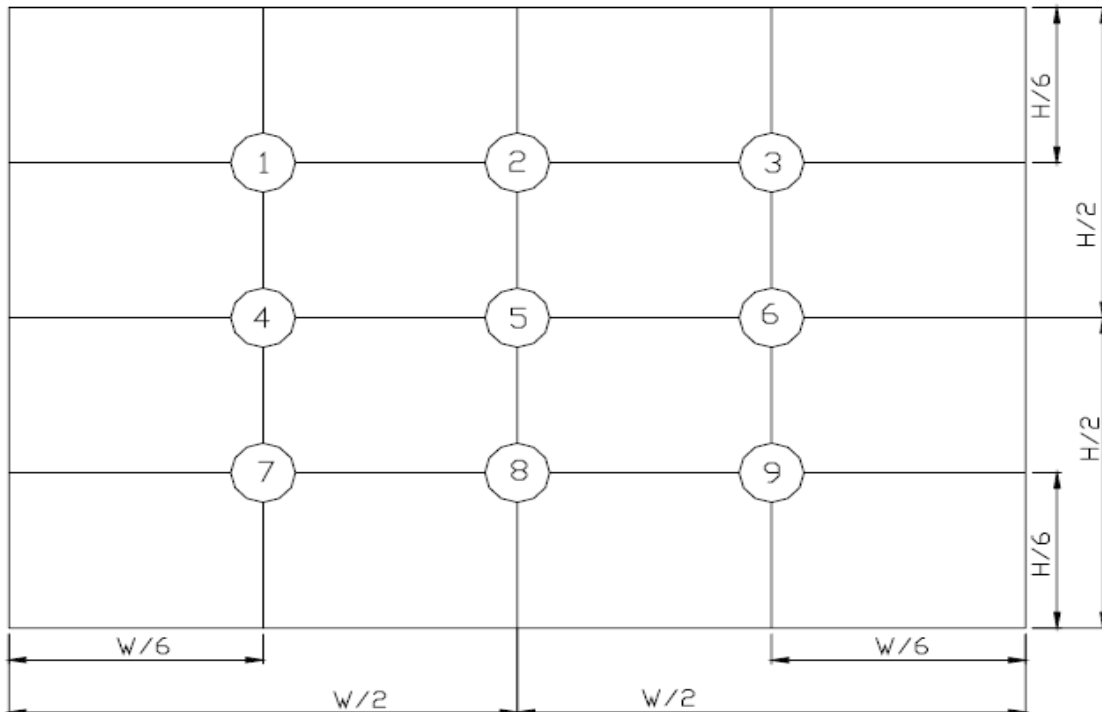

**14. Reliability Test**

No.	Test Items	Test Condition	Remark
1	High Temperature Storage Test	T _a = 80°C 240 hours	-
2	Low Temperature Storage Test	T _a = -30°C 240 hours	-
3	High Temperature Operation Test	T _a = 70°C 240 hours	-
4	Low Temperature Operation Test	T _a = -20°C 240 hours	-
5	High Temperature and High Humidity Operation Test	T _a =60°C 90%RH 240 hours	-
6	Electro Static Discharge Test (non-operating)	-Panel Surface/Top Case : 150pF, 330Ω Air: ±15kV, Contact: ±8kV	-
7	Mechanical Shock Test (non-operating)	Half sine wave, 100G, 6ms 3 times shock of each six surfaces	-
8	Vibration Test (non-operating)	Sine wave, 10 ~ 55 ~ 10Hz, 3 axis, 2 hours/axis	-
9	Thermal Shock Test (non-operating)	-20°C(30min) ~ 70°C(30min), 100 cycles	-
10	Drop Test(with Carton)	Height: 80cm 1 corner, 3 edges, 6 surfaces	-



15. Packaging

Packing Method

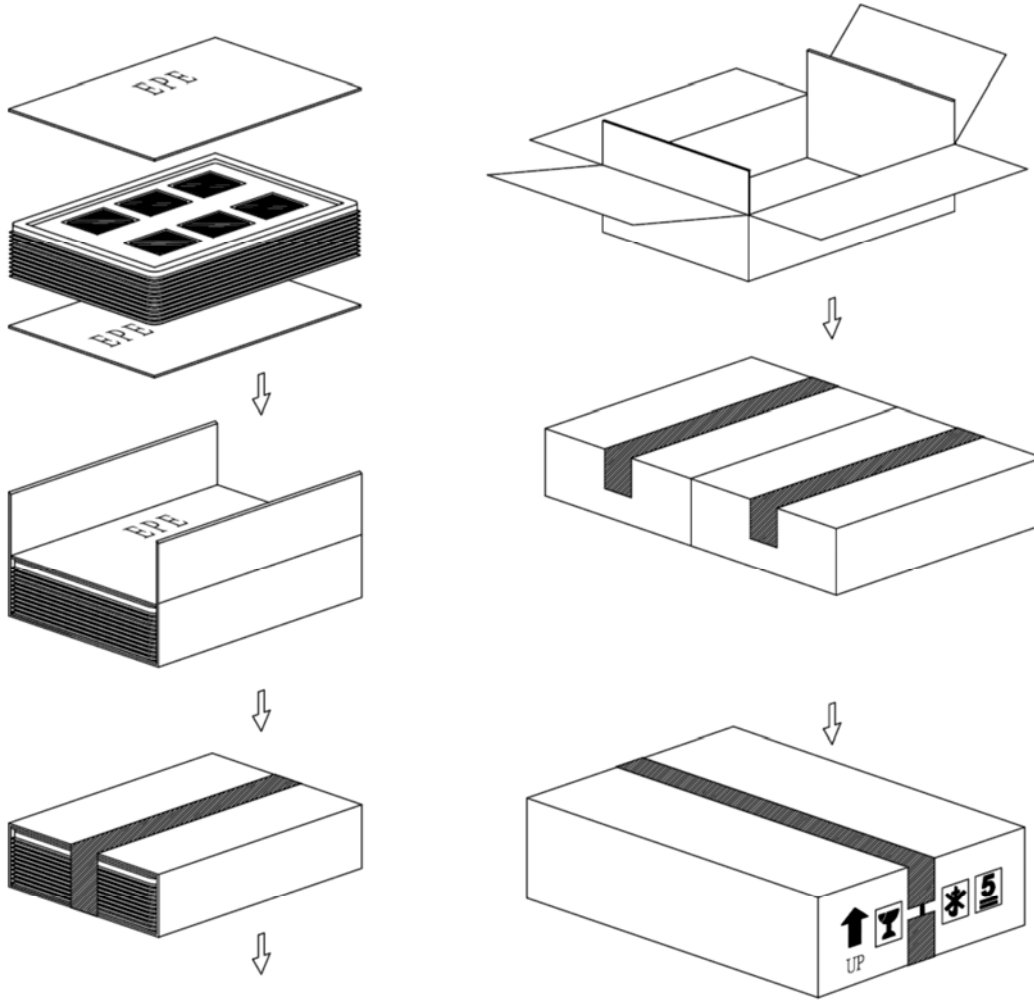

PARTS LIST					
	ITEM	SIZE(LxWxH) unit:mm	MATERIAL	Q.T.Y	NOTE
1	TRAY	372.0x262.0x16.0	PS	28	
2	CARD BOARD(P01)	816.0x375.0x3.5	CARTON	2	
3	CARD BOARD(P02)	945.0x275.0x3.5	CARTON	2	
4	CARD BOARD(P03)	375.0x265.0x3.5	CARTON	4	
5	INTERNAL BOX(S01)	400.0x290.0x150.0	CARTON	2	
6	EXTERNAL BOX(L02)	600.0x420.0x170.0	CARTON	1	
7	PRODUCT	76.9x63.9x4.4		156	



16. Precautions

16.1 Assembly and Handling Precautions

- (1) Do not apply rough force such as bending or twisting to the module during assembly.
- (2) It's recommended to assemble or to install a module into the user's system in clean working areas. The dust and oil may cause electrical short or worsen the polarizer.
- (3) Don't apply pressure or impulse to the module to prevent the damage of LCD panel and Backlight.
- (4) Always follow the correct power-on sequence when the LCD module is turned on. This can prevent the damage and latch-up of the CMOS LSI chips.
- (5) Do not plug in or pull out the I/F connector while the module is in operation.
- (6) Do not disassemble the module.
- (7) Use a soft dry cloth without chemicals for cleaning, because the surface of polarizer is very soft and easily scratched.
- (8) Moisture can easily penetrate into LCD module and may cause the damage during operation.
- (9) High temperature or humidity may deteriorate the performance of LCD module. Please store LCD module in the specified storage conditions.
- (10) When ambient temperature is lower than 10°C, the display quality might be reduced. For example, the response time will become slow.

16.2 Safety Precautions

- (1) If the liquid crystal material leaks from the panel, it should be kept away from the eyes or mouth. In case of contact with hands, skin or clothes, it has to be washed away thoroughly with soap.
- (2) After the module's end of life, it is not harmful in case of normal operation and storage.

16.3 Terms of Warrant

- (1) Acceptance inspection period
The period is within one month after the arrival of contracted commodity at the buyer's factory site.
- (2) Applicable warrant period
The period is within twelve months since the date of shipping out under normal using and storage conditions.



16.4 Cautions for installing and assembling

Bezel edge must be positioned in the area between the Active area and View area.
The bezel may press the touch screen and cause activation if the edge touches the active area. A gap of approximately 0.5mm is needed between the bezel and the top electrode. It may cause unexpected activation if the gap is too narrow. There is a tolerance of 0.2 to 0.3mm for the outside dimensions of the touch panel and tail. A gap must be made to absorb the tolerance in the case and connector.

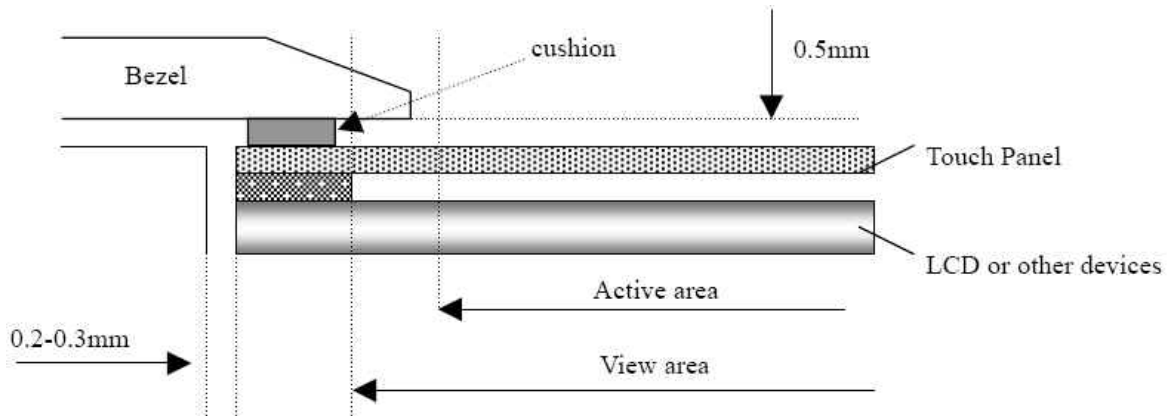

16.5 Operation Prohibit

Not Suggested Pen Input Position On Touch Panel

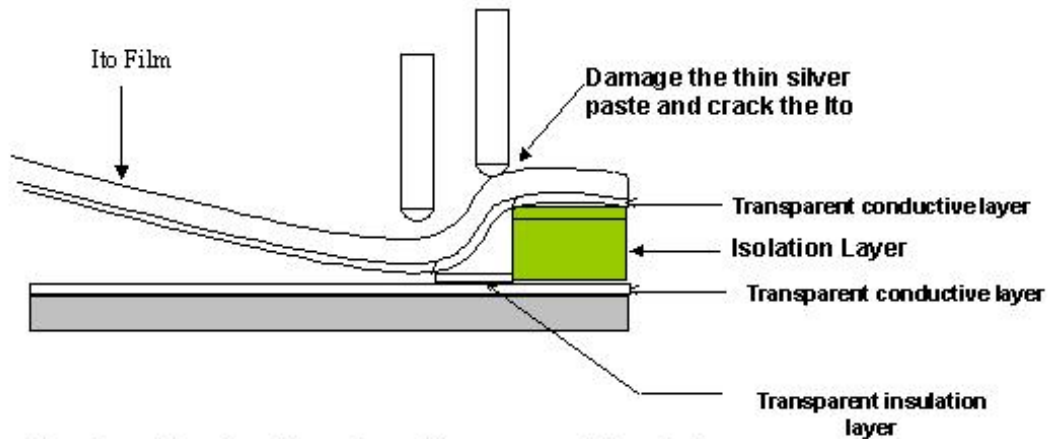

Pen input load on the edge of transparent insulation area might damage the ITO of ITO Pet- Film and reduce the durability of touch panel



16.6 Cautions for LCM's installing and assembling

Please keep away the FPC while assembling or fixing the LCM to avoid FPC being damaged or extruded or other related problems. Please see below picture.

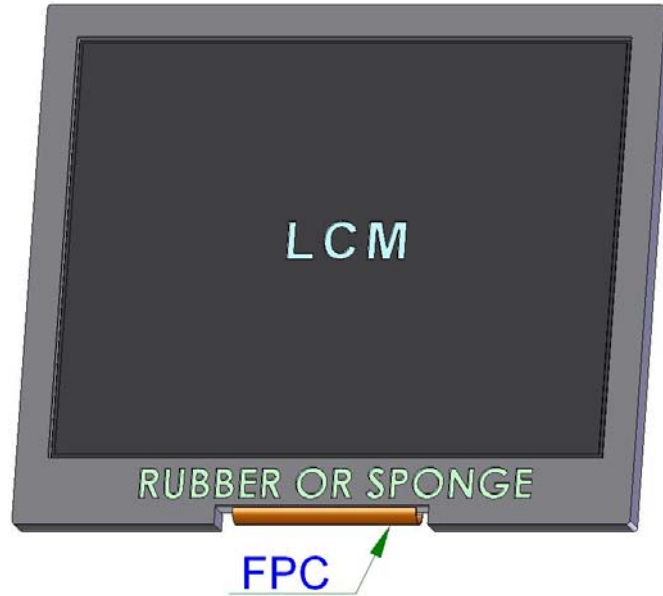



17. Outline Drawing

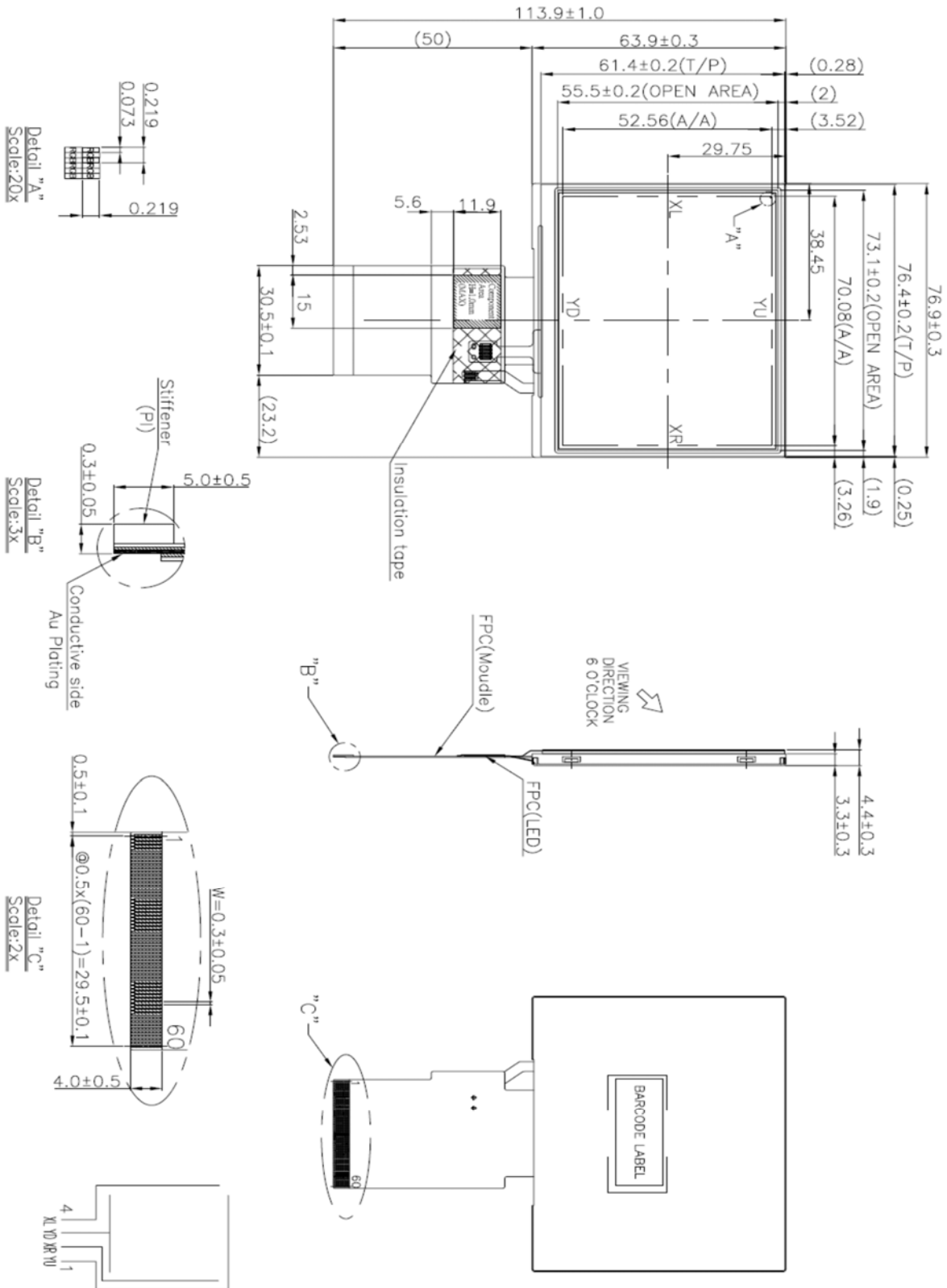



18. Definition of Labels

The bar code nameplate is pasted on each module as illustration, and its definitions are as following explanation.

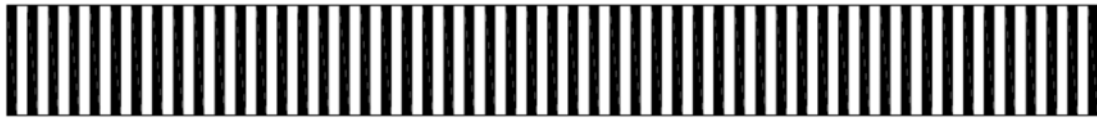

PT322435-TLMWD-E23B

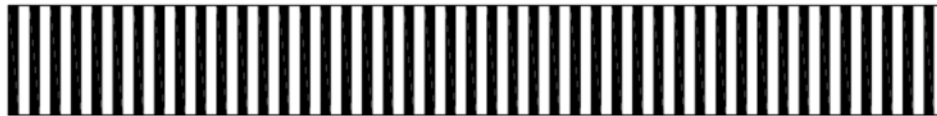

ABCDEFGHIJKLM

(a) Module Name: PT322435B-TLMWD-E23B

(b) Serial ID:

A B C D E F G H I J K L M

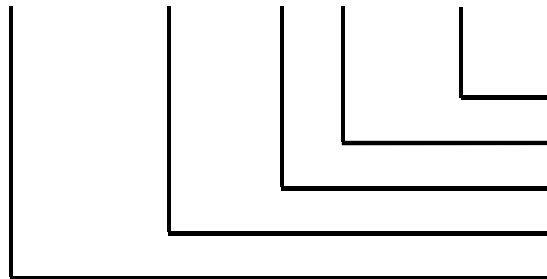

Serial No.
Revision Code
Factory Code
Manufactured Date
Screen Size

Serial ID includes the information as below:

(a) Screen size (Diagonal): Inch Code (ABCD)

3.5" → 0350

10.4" → 1040

(b) Manufactured Date: Year, Month, Day (EFG)

Year (E)

Year	2000	2001	2002	2003	2004	2005	2006	2007	2008	2009
Mark	0	1	2	3	4	5	6	7	8	9
Year	2010	2011	2012	2013	2014	2015	2016	2017	2018	2019
Mark	A	B	C	D	E	F	G	H	I	J



Month (F)

Month	Jan.	Feb.	Mar.	Apr.	May	Jun.	Jul.	Aug.	Sep.	Oct.	Nov.	Dec.
Mark	1	2	3	4	5	6	7	8	9	A	B	C

Day (G)

Day	1	2	3	4	5	6	7	8	9	10	11	12	13	14	15	16
Mark	1	2	3	4	5	6	7	8	9	A	B	C	D	E	F	G
Day	17	18	19	20	21	22	23	24	25	26	27	28	29	30	31	
Mark	H	I	J	K	L	M	N	O	P	Q	R	S	T	U	V	

(c) Factory Code (H):

For P-TEC internal use.

(d) Revision Code (I):

Cover all the change, for example: 1: Rev.1, 2: Rev.2, 3: Rev.3...etc.

(e) Serial No. (JKLM):

Manufacturing sequence of product, for example: 0001~9999.



19. Incoming Inspection Standards

19.1 The environmental condition of inspection

The environmental condition and visual inspection shall be conducted as below.

- (1) Ambient temperature $25 \pm 5^{\circ}\text{C}$
- (2) Humidity: $60 \pm 5\% \text{ RH}$
- (3) Viewing distance is approximately 35 ~ 40 cm
- (4) Viewing angle is normal to the LCD panel as Fig_1(10°)
- (5) Ambient Illumination: 300 ~ 500 Lux for external appearance inspection

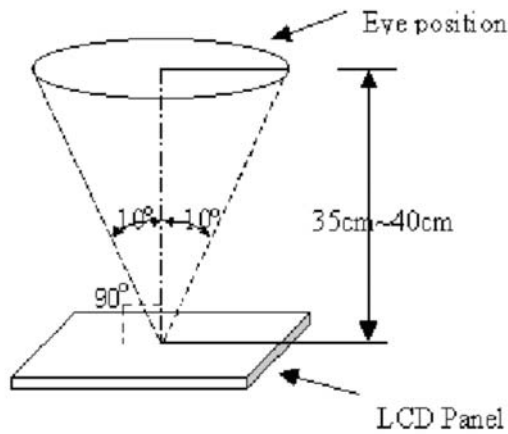

Fig_1

19.2 The defects classify of AQL as following:

Class of defects	AQL	Definition
Major	0.65%	It is defect that is likely to result in failure or to reduce materially the usability of the intended function.
Minor	1.5%	It is a defect that will not result in functioning problem with deviation classified.



19.3 Inspection Parameters

Item		Specification/Description			Note	
Display	Function	No Display			-	
		Malfunction			-	
Operating	Contrast ratio	Out of Spec			-	
	Line defect	No obvious Vertical and Horizontal line defect in bright , dark and colored.			-	
	Point Defect (red,green,blue,dark, white)	Item	Acceptable number			Note: 1、4、 5、6
			A	B	Total	
		BRIGHT DOT	$N \leq 0$	$N \leq 2$	$N \leq 6$	
		DARK DOT	$N \leq 2$	$N \leq 4$		
		TOTAL DOT	$N \leq 2$	$N \leq 4$		
TWO ADJACENT DOT	NOT ALLOWED					
THREE OR MORE ADJACENT DOT	NOT ALLOWED					
External Inspection (non-operating)	Scratch on the polarizer	L(mm)	W(mm)	Acceptable number	Note:2	
		$L \leq 2.5$	$W \leq 0.1$	3		
		$L > 2.5$	$W > 0.1$	0		
	Dent or bubble on the polarizer	Dimension(mm)		Acceptable number		Note:3
		$D \leq 0.3$		3		
		$D \leq 0.1$		Disregard		
	Foreign material on the polarizer	Dimension(mm)		Acceptable number		Note:3
		$D \leq 0.5$		2		
		$D \leq 0.1$		Disregard		

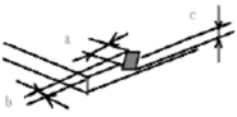
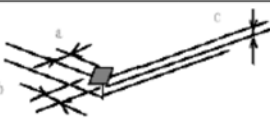
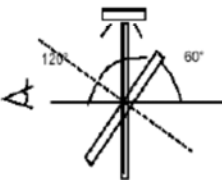
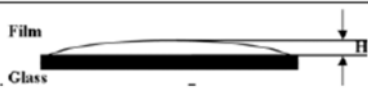

Item		Specification/Description			Note
Touch Panel	Scratch	L(mm)	W(mm)	Acceptable number	Note:2
		$L \leq 10$	$W < 0.05$	Disregard	
			$0.05 \leq W < 0.1$	$N \leq 4$	
			$W \geq 0.1$	0	
	Foreign Materials (Linear shape)	$L \leq 10$	$W < 0.05$	Disregard	Note:2
			$0.05 \leq W < 0.1$	$N \leq 3$	
			$W \geq 0.1$	0	
	Foreign Materials (Circular shape)	Dimension(mm)		Acceptable number	Note:3
		$D \leq 0.25$		Disregard	
		$0.25 < D \leq 0.5$		$N \leq 6$	
$D > 0.5$		0			
Glass chipping				$a \leq 5.0\text{mm}$ $b \leq 3.0\text{mm}$ $c \leq t$ (t : Glass think)	Note:7
				$a \leq 3.0\text{mm}$ $b \leq 3.0\text{mm}$ $c \leq t$ (t : Glass think)	Note:7
Newton-ring	(In case of doubtful situations) Observe on 60° from the product surface under a white Fluorescent lamp (3-wavelength lamp).		Average diameter $\leq 1/3$ Touch Panel area Disregard.	Note:7	
					
Membrane Drum			$H \leq 0.3\text{mm}$		



Note1. The definition of dot defect : The dot defect was judged after repair and the size of a defective dot over 1/2 of whole dot is regarded as one defective dot.

Note2.

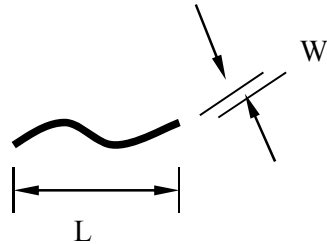

Note3. D : Diameter $D=(a+b)/2$

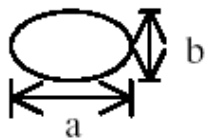

Note4. Bright dot is defined through 6% transmission ND Filter as following.

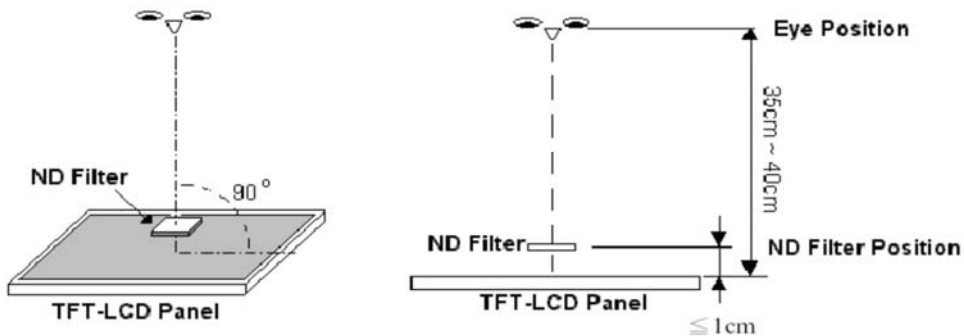

Note5. ADJACENT DOT





Note6.

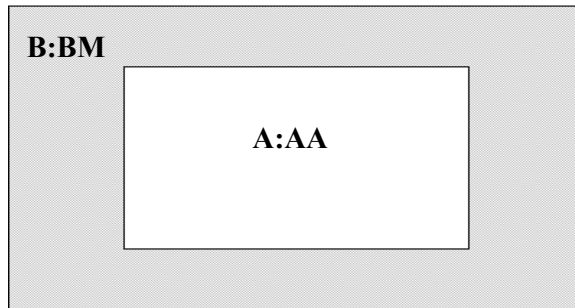

Note7.

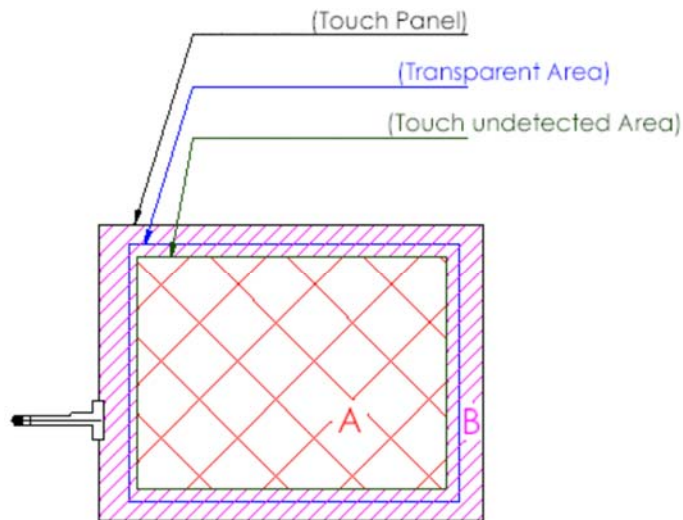

A area : Without any defect point effect on normal operation.

B area : None-specify

19.4 Handling of LCM

- (1) Don't give external shock.
- (2) Don't apply excessive force on the surface.
- (3) Liquid in LCD is hazardous substance. Must not lick and swallow. when the liquid is attach to your hand, skin, cloth etc. Wash it out thoroughly and immediately.
- (4) Don't operate it above the absolute maximum rating.
- (5) Don't disassemble the LCM.