

Package: PLL350, 20.32mm x 14.78mm x 3.91mm



Features

- Low Phase Noise / Fast Settling Time
- SPI Bus Compatible
- Frequency: 1930MHz to 1990MHz
- Resonator: Aircoil
- PCB: FR4 and S1170
- Package Size: 20.32mm x 14.78mm x 3.91mm (0.8in x 0.582in x 0.154in)

Applications

- Cellular Infrastructure
- RFID
- General Wireless

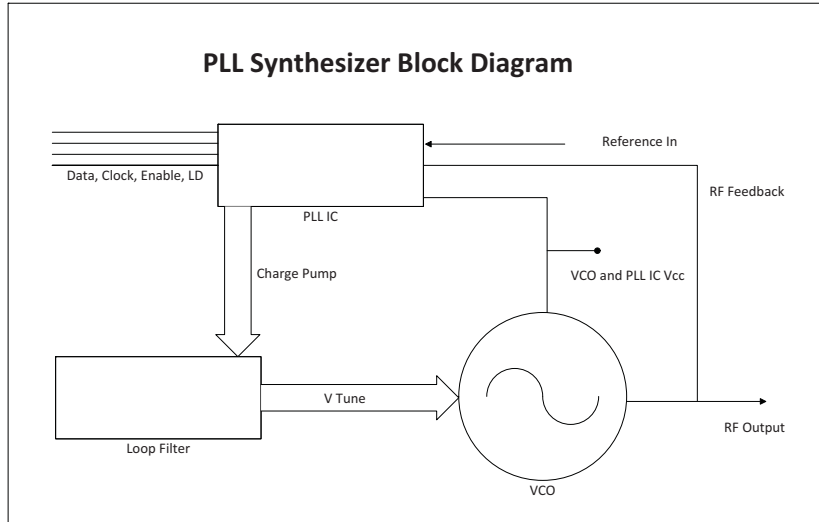

Functional Block Diagram

Product Description

RFMD® offers complete Phase Locked Modules (PLLs) integrating a PLL IC, a VCO, loop filter components, and buffer amplifiers. RFMD has a broad selection of oscillator topologies, resonator technologies, supply voltages, and substrate materials available, allowing us to provide customers with a PLL solution that meets the specific cost, performance, and size requirements for their applications.

Ordering Information

PLL350-1960Y Contact us at 1-480-756-6070

Optimum Technology Matching® Applied

- | | | | |
|--------------------------------------|--------------------------------------|--|------------------------------------|
| <input type="checkbox"/> GaAs HBT | <input type="checkbox"/> SiGe BiCMOS | <input type="checkbox"/> GaAs pHEMT | <input type="checkbox"/> GaN HEMT |
| <input type="checkbox"/> GaAs MESFET | <input type="checkbox"/> Si BiCMOS | <input type="checkbox"/> Si CMOS | <input type="checkbox"/> BiFET HBT |
| <input type="checkbox"/> InGaP HBT | <input type="checkbox"/> SiGe HBT | <input checked="" type="checkbox"/> Si BJT | <input type="checkbox"/> LDMOS |

RF MICRO DEVICES®, RFMD®, Optimum Technology Matching®, Enabling Wireless Connectivity™, PowerStar®, POLARIS™ TOTAL RADIO™ and UltimateBlue™ are trademarks of RFMD, LLC. BLUETOOTH is a trademark owned by Bluetooth SIG, Inc., U.S.A. and licensed for use by RFMD. All other trade names, trademarks and registered trademarks are the property of their respective owners. ©2006, RF Micro Devices, Inc.

Absolute Maximum Ratings

Parameter	Rating	Unit
Operating Ambient Temperature	-40 to +85	°C
Storage Temperature	-55 to +125	°C



Caution! ESD sensitive device.

Exceeding any one or a combination of the Absolute Maximum Rating conditions may cause permanent damage to the device. Extended application of Absolute Maximum Rating conditions to the device may reduce device reliability. Specified typical performance or functional operation of the device under Absolute Maximum Rating conditions is not implied.

The information in this publication is believed to be accurate and reliable. However, no responsibility is assumed by RF Micro Devices, Inc. ("RFMD") for its use, nor for any infringement of patents, or other rights of third parties, resulting from its use. No license is granted by implication or otherwise under any patent or patent rights of RFMD. RFMD reserves the right to change component circuitry, recommended application circuitry and specifications at any time without prior notice.



RoHS (Restriction of Hazardous Substances): Compliant per EU Directive 2002/95/EC.

Parameter	Specification			Unit	Condition
	Min.	Typ.	Max.		
Overall					
Frequency Range	1930	1960	1990	MHz	
Step Size		200		kHz	
Settling Time		0.4	0.5	ms	To within 1.0kHz
Output Power	0	3	6	dBm	
Output Phase Noise		-83	-77	dBc/Hz	1 kHz
		-114	-108	dBc/Hz	100kHz
		-141	-135	dBc/Hz	800kHz
Spurious Product		-85	-70	dBc	200kHz
Reference Feedthrough		-85	-70	dBc	
Harmonic Suppression		-25	-15	dBc	2nd harmonic
		-30	-20	dBc	3rd harmonic
Reference Oscillator Signal		10		MHz	Frequency
	0.4		3	Vp-p	Amplitude
		-145		dBc/Hz	Phase noise - 1kHz
		100		kΩ	Input impedance
Output Impedance		50		Ω	
Power Supply					
Operating Voltage	4.75	5	5.25	V	VCO
	2.9	3	3.1	V	PLL IC
Supply Current		35	50	mA	VCO
		10	15	mA	PLL IC

PLL Synthesizer Programming

Refer to Application Note 113, Option 20700.

Package Drawing & Pin Outs

20.32mm x 14.78mm x 3.91mm (0.8in x 0.582in x 0.154in)

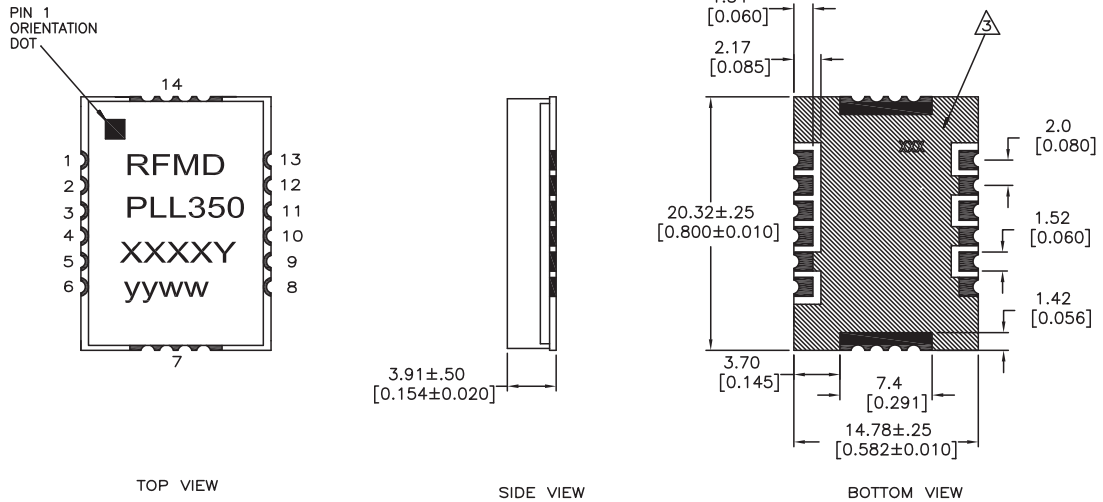

PIN OUT FOR PLL	
PIN	APPLICATION
1	VCC PLL
3	REFERENCE IN
5	VCC VCO
8	RF OUT
10	LOCK DETECT
11	CLOCK
12	DATA
13	ENABLE

ALL OTHER PINS ARE GROUND

NOTE, UNLESS OTHERWISE SPECIFIED:

1. THE METAL CASE IS GROUND.
2. ALL HALF VIA CONTACTS ARE PLATED THRU FROM THE PAD ON THE TOP SIDE TO THE PAD ON THE BOTTOM SIDE OF THE BOARD.
3. HATCHED AREAS ARE GROUND AND ARE COVERED WITH LPI SOLDER MASK OVER BARE COPPER. ALL CONTACT AREAS ARE PLATED. SIGNAL VIAS MAY BE LOCATED WITHIN GROUND PLANE.
4. CROSS HATCHED AREA INDICATES AREA WHERE SOLDER MASK SHOULD BE APPLIED TO MOUNTING BOARD.
5. SUBSTRATE MATERIAL: FR-4.
6. XXXX REPRESENTS THE MODEL NUMBER.
7. yyww IS THE DATE CODE.
8. Y AT THE END OF MODEL NUMBER DESIGNATES RoHS COMPLIANCE.
9. DIMENSIONS ARE IN MILLIMETERS AND [INCHES].