

MTR (40) Single, Dual and Triple DC-DC Converters

28 (16-40) VOLT INPUT – 30 WATT

FEATURES

No cross-regulation error in triple output models

Operating temperature -55° to +125°C

- Input voltage range 16 to 40 VDC
- Transient protection 50 Vin for 50 ms
- Fully isolated, magnetic feedback
- Fixed high frequency switching
- Inhibit and synchronization function
- Indefinite short circuit and overload protection



ALSO SEE OUR IMPROVED MTR (50)
16 - 50 Vin, 80 V transient / 50 ms.
Datasheet at www.interpoint.com/mtr50

MODELS VDC OUTPUT		
SINGLE	DUAL	TRIPLE
3.3	±5	+5 & ±12
5	±12	+5 & ±15
12	±15	
15		
18		

DESCRIPTION

The Interpoint™ MTR Series™ of dc-dc converters offers up to 30 watts of output power from single, dual, or triple output configurations. MTR (40) models have an input voltage range of 16 to 40 and transient protection up to 50 Vin for up to 50 milliseconds. They operate over the full military temperature range with up to 84% efficiency. MTR converters are packaged in hermetically sealed metal cases, making them ideal for use in military, aerospace and other high reliability applications. The converters are offered with standard screening, “ES” screening, or fully compliant to “883” MIL-PRF-38534 Class H screening. See “Table 12: Element Evaluation” on page 25 and “Table 13: Environmental Screening” on page 26 for more information. Standard microcircuit drawings (SMD) are available. See “Table 3: SMD Number Cross Reference” on page 8.

CONVERTER DESIGN

The MTR converters are constant frequency, pulse-width modulated switching regulators which use a quasi-square wave, single ended, forward converter design. Tight load regulation is maintained via wide bandwidth magnetic feedback and, on single output models, through use of remote sense. On dual output models, the positive output is independently regulated and the negative output is cross regulated through the use of tightly coupled magnetics. The MTR Series triple output dc-dc converter’s design includes individual regulators on the auxiliary outputs which provide for no cross regulation error when a minimum 300 mA load is maintained on the main (+5) output.

Indefinite short circuit protection and overload protection are provided by a constant current-limit feature. This protective system senses current in the converter’s secondary stage and limits it to approximately 125% of the maximum rated output current.

MTR converters are provided with internal filtering capacitors that help reduce the need for external components in normal operation. Use our FMCE-0328™, FMCE-0528™ or FMCE-0828™ EMI filter to meet the requirements of MIL-STD-461C CE03 and CS01 and/or MIL-STD-461D, E and F CE102 and CS101 levels of conducted emissions. Or use the FM-704A for transient suppression and to meet MIL-STD-461C CE03.

COVER MARKING

The cover marking for the MTR 40 is “MTR DC-DC CONVERTER” under the model number. See “Figure 11: Cover Marking for MTR - 40 Vin” on page 8.

SYNCHRONIZATION

Synchronizing the converter with the system clock allows the designer to confine switching noise to clock transitions, minimizing interference and reducing the need for filtering. In sync mode, the converter will run at any frequency between 500 kHz and 675 kHz for singles and duals and between 500 and 700 kHz for triples. The sync control operates with a duty cycle between 40% and 60%. The sync pin must be connected to input common pin when not in use.

MTR (40) Single, Dual and Triple DC-DC Converters

28 (16-40) VOLT INPUT – 30 WATT

WIDE INPUT VOLTAGE RANGE

MTR converters are designed to provide full power over a full 16 to 40 VDC input voltage range. Operation below 16 volts, including MIL-STD-704A emergency power conditions is possible with derated power. Refer to the low line dropout graphs ("Figure 27", "Figure 35" and "Figure 36") for details.

DYNAMIC RESPONSE

The MTR Series feed-forward compensation system provides excellent dynamic response and noise rejection. Audio rejection is typically 40 dB for singles and duals and 50 dB for triples. The minimum to maximum step line transition response is typically less than 4%.

INHIBIT FUNCTION

MTR converters provide an inhibit terminal that can be used to disable internal switching, resulting in no output voltage and very low quiescent input current. The converter is inhibited when the inhibit pin is pulled below 0.8 V and enabled when its inhibit pin is left floating. An external inhibit interface should be capable of pulling the converter's inhibit pin below 0.8 V while sinking the maximum inhibit current and also allowing the inhibit pin to float high to enable the converter. A voltage should not be applied to the inhibit pin. The open circuit voltage present on the inhibit pin is 9 to 11 V.

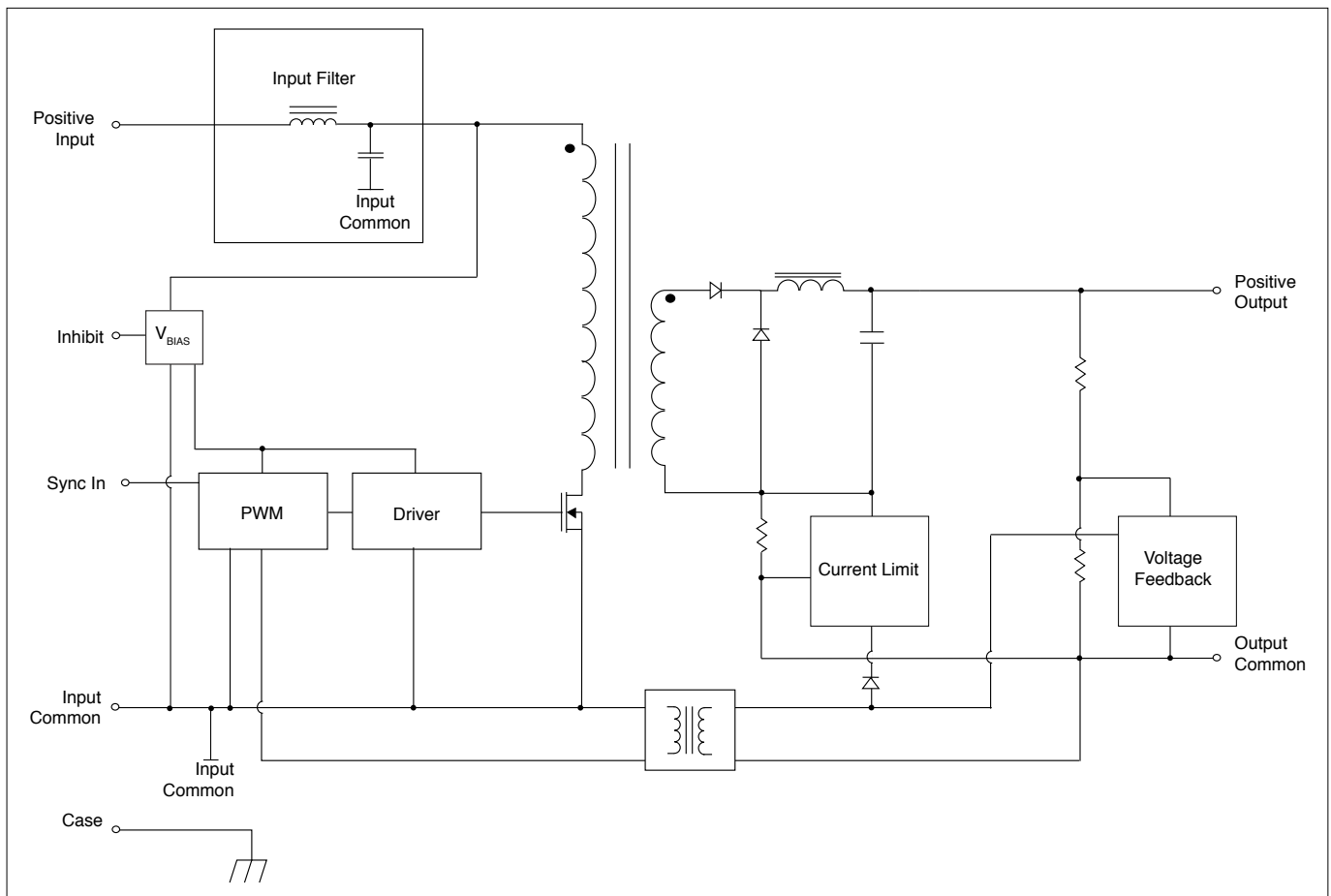

FIGURE 1: MTR SINGLE BLOCK DIAGRAM

MTR (40) Single, Dual and Triple DC-DC Converters

28 (16-40) VOLT INPUT – 30 WATT

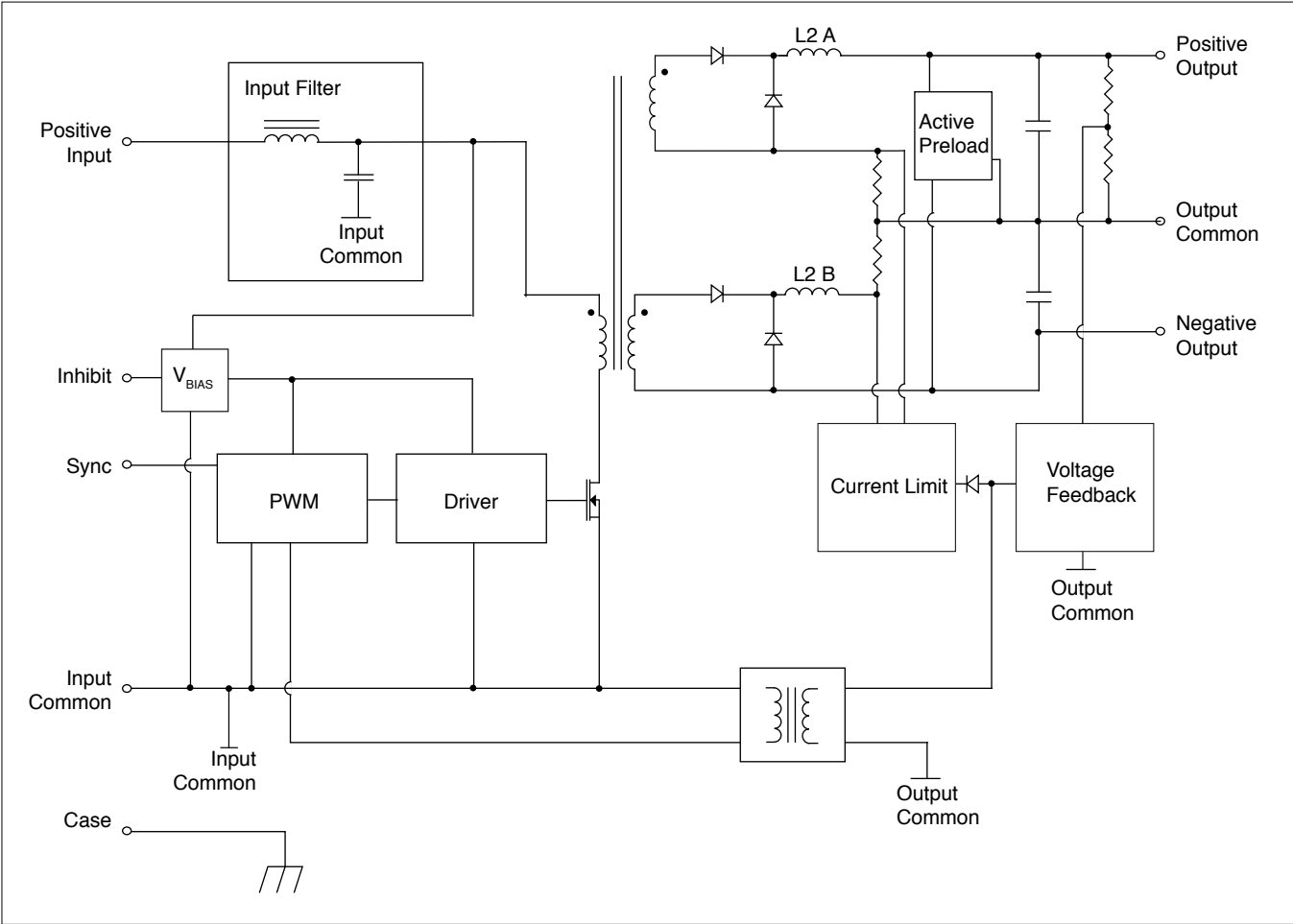

FIGURE 3: MTR DUAL NON-883 BLOCK DIAGRAM

MTR (40) Single, Dual and Triple DC-DC Converters

28 (16-40) VOLT INPUT – 30 WATT

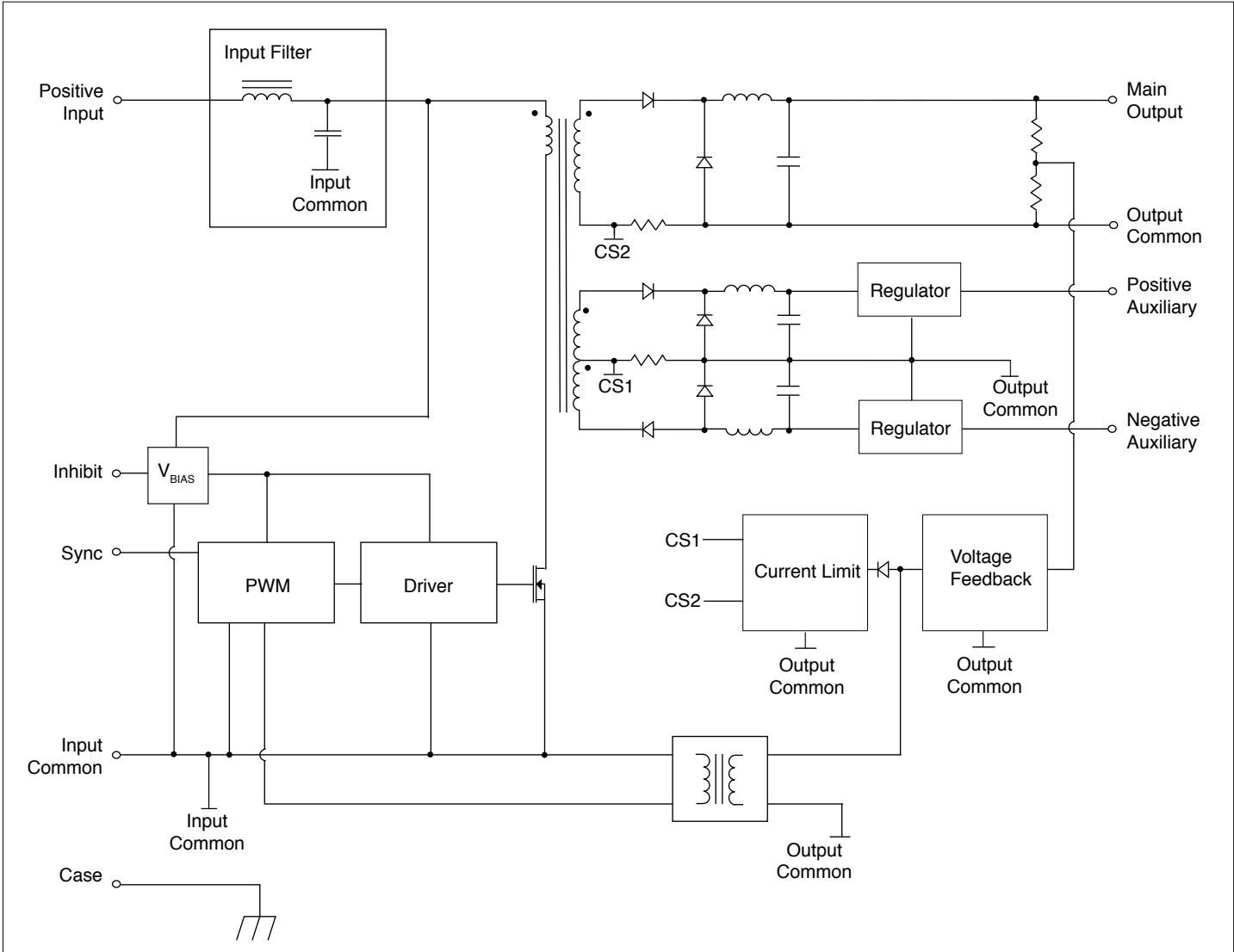

FIGURE 4: MTR TRIPLE BLOCK DIAGRAM

MTR (40) Single, Dual and Triple DC-DC Converters

28 (16-40) VOLT INPUT – 30 WATT

TRIM AND REMOTE SENSE (AVAILABLE ON SINGLE 5, 12 AND 15 OUTPUT MODELS ONLY)

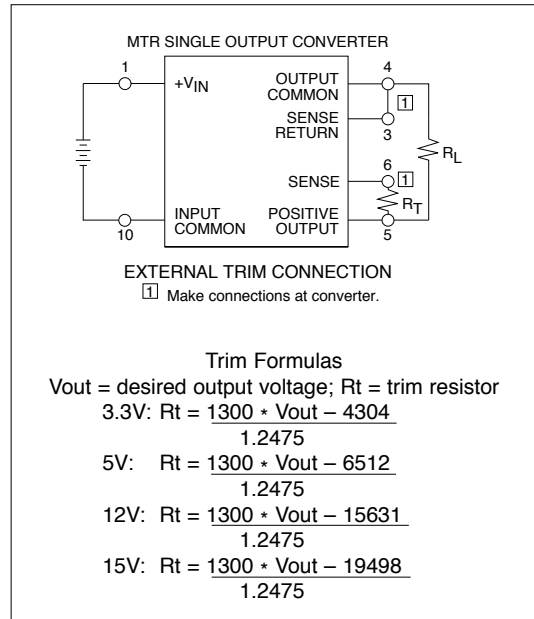

FIGURE 5: TRIM CONNECTION 1, 2, 3

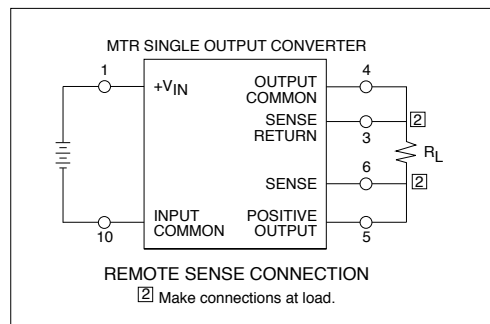

FIGURE 6: REMOTE SENSE CONNECTION 4

Notes for Remote Sense and Trim

- When trimming output voltage and/or remote sensing, the total output voltage increase must be less than 0.6 volts at the converters pins. Do not exceed the maximum power.
- If neither voltage trim nor remote sense will be used, connect pin 3 to pin 4 and pin 5 to pin 6.
- CAUTION:** The converter will be permanently damaged if the remote sense (pin 6) is shorted to ground. Damage may also result if the output common or positive output is disconnected from the load with the remote sense leads connected to the load.
- When using remote sense for voltage compensation or when using remote sense for trim, the output will drift over temperature. Contact Applications Engineering for more information at powerapps@crane-eg.com

MTR (40) Single, Dual and Triple DC-DC Converters

28 (16-40) VOLT INPUT – 30 WATT

PIN OUT			
Pin	Single Output	Dual Output	Triple Output
1	Positive Input	Positive Input	Positive Input
2	Inhibit	Inhibit	Main (+5) Output
3	Sense Return	Positive Output	Output Common
4	Output Common	Output Common	Neg. Aux. Output
5	Positive Output	Negative Output	Pos. Aux. Output
6	Positive Sense	Case Ground	Case Ground
7	Case Ground	Case Ground	Case Ground
8	Case Ground	Case Ground	Inhibit
9	Sync	Sync	Sync
10	Input Common	Input Common	Input Common

TABLE 1: PIN OUT

PINS NOT IN USE	
Inhibit	Leave unconnected
Sync In	Connect to input common
Sense Lines	Must be connected to appropriate outputs

TABLE 2: PINS NOT IN USE

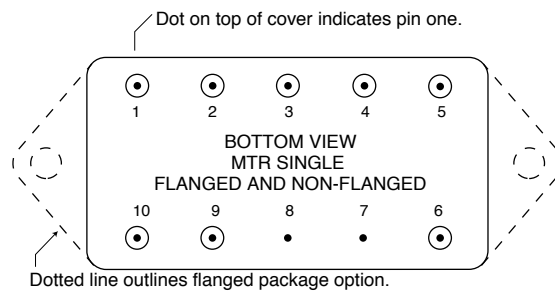

See "Figure 38: Case H2 – Single and 883 Dual Models" on page 20 and "Figure 41: Case K3 – Single and Dual 883 Models" on page 23 for dimensions.

FIGURE 7: PIN OUT SINGLE OUTPUT MODELS

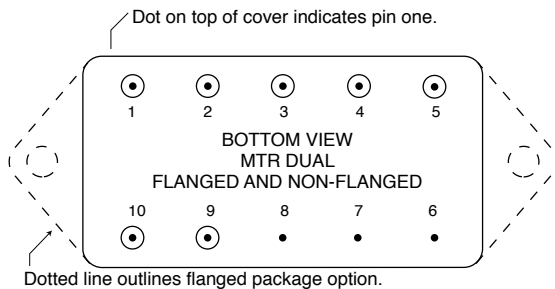

See "Figure 38: Case H2 – Single and 883 Dual Models" on page 20, "Figure 39: Case H4 – Dual Models - non 883" on page 21, "Figure 41: Case K3 – Single and Dual 883 Models" on page 23 and "Figure 42: Case K5 – Dual Models - non 883" on page 24 for dimensions.

FIGURE 9: PIN OUT DUAL OUTPUT MODELS

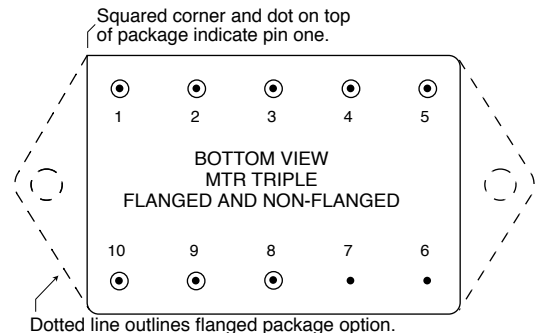

See "Figure 37: Case F1 – Triple Models" on page 19 and "Figure 40: Case J1 – Triple Models" on page 22 for dimensions.

FIGURE 8: PIN OUT TRIPLE OUTPUT MODELS

MTR (40) Single, Dual and Triple DC-DC Converters

28 (16-40) VOLT INPUT – 30 WATT

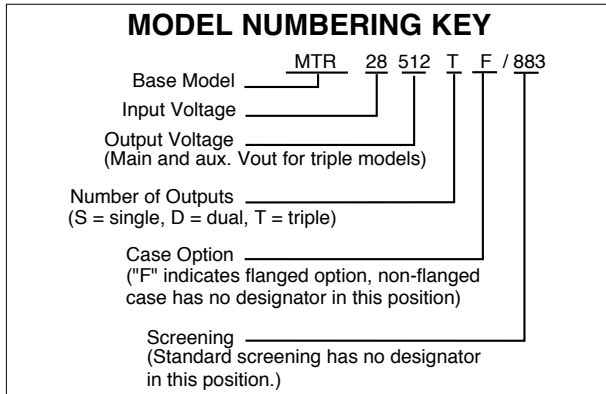

FIGURE 10: MODEL NUMBERING KEY



FIGURE 11: COVER MARKING FOR MTR - 40 VIN

(NOTE: COVER MARKING FOR MTR (50) - 50 VIN IS "MTR (50) DC-DC CONVERTER" UNDER THE MODEL NUMBER)

SMD NUMBERS		
STANDARD MICROCIRCUIT DRAWING (SMD)	SMD REVISION NUMBER ¹	MTR SIMILAR PART
5962-0150101HXC	D	MTR283R3S/883
5962-9306801HXC	G	MTR2805S/883
5962-9306901HXC	G	MTR2812S/883
5962-9307001HXC	E	MTR2815S/883
5962-9320501HXC	E	MTR2805D/883
5962-9307101HXC	E	MTR2812D/883
5962-9307201HXC	G	MTR2815D/883
5962-9307301HXC	F	MTR28512T/883
5962-9307401HXC	H	MTR28515T/883

1. The SMD revision number distinguishes the MTR (40) converter from the MTR (50) converter. The SMD numbers are the same. If ordering to the SMD number, please order to the desired SMD revision, listed above, for the MTR (40).

To indicate the flanged case option change the "X" to "Z" in the SMD number. The SMD number shown is for Class H screening, non-flanged. See the SMD for the numbers for other screening and radiation levels. For exact specifications for an SMD product, refer to the SMD drawing. SMDs can be downloaded from: <http://www.dsccl.dla.mil/programs/smcr>

TABLE 3: SMD NUMBER CROSS REFERENCE

MODEL NUMBER OPTIONS					
TO DETERMINE THE MODEL NUMBER ENTER ONE OPTION FROM EACH CATEGORY IN THE FORM BELOW.					
CATEGORY	Base Model and Input Voltage	Output Voltage ¹	Number of Outputs ²	Case Options ³	Screening ⁴
OPTIONS	MTR28	3R3, 05, 12, 15, 18	S	(non-flanged, leave blank)	(standard, leave blank)
		05, 12, 15	D	F (flanged)	ES
		512, 515	T		883
FILL IN FOR MODEL #	MTR28	_____	_____	_____	/ _____

Notes:

- Output Voltage: An R indicates a decimal point. 3R3 is 3.3 volts out. The value of 3R3 and 18 are only available in single output models. The 512 and 515 triple output converters are +5 volt main and ±12 or ±15 volt auxiliaries.
- Number of Outputs: S is a single output, D is a dual output, and T is a triple output
- Case Options: For the standard case ("Figure 38: Case H2 – Single and 883 Dual Models" on page 20, "Figure 39: Case H4 – Dual Models - non 883" on page 21 and "Figure 37: Case F1 – Triple Models" on page 19) leave the case option blank. For the flanged case option ("Figure 41: Case K3 – Single and Dual 883 Models" on page 23, "Figure 42: Case K5 – Dual Models - non 883" on page 24 and "Figure 40: Case J1 – Triple Models" on page 22), insert the letter F in the Case Option position.
- Screening: For standard screening leave the screening option blank. For other screening options, insert the desired screening level. For more information see "Table 12: Element Evaluation" on page 25 and "Table 13: Environmental Screening" on page 26.

TABLE 4: MODEL NUMBER OPTIONS

MTR (40) Single, Dual and Triple DC-DC Converters

28 (16-40) VOLT INPUT – 30 WATT

TABLE 5: OPERATING CONDITIONS, ALL MODELS : 25°C T_C, 28 VDC VIN, 100% LOAD, UNLESS OTHERWISE SPECIFIED.

PARAMETER	CONDITIONS	ALL MODELS			UNITS
		MIN	TYP	MAX	
LEAD SOLDERING TEMPERATURE ¹	10 seconds max.	–	–	300	°C
STORAGE TEMPERATURE ¹		-65	–	+150	°C
CASE OPERATING TEMPERATURE	FULL POWER	-55	–	+125	°C
	ABSOLUTE ¹	-55	–	+135	
DERATING OUTPUT POWER/CURRENT ¹	LINEARLY	From 100% at 125°C to 0% at 135°C			
ESD RATING ¹ CLASS 1 MIL-PRF-38534, 3.9.5.8.2	MIL-STD-883 METHOD 3015	0 - 1999			V
ISOLATION, ANY PIN TO CASE EXCEPT CASE PIN	@ 500 VDC AT 25°C	100	–	–	Megohms
INPUT TO OUTPUT CAPACITANCE ¹	SINGLES AND DUALS	–	50	–	pF
	TRIPLES	–	100	–	
CURRENT LIMIT ²	% OF FULL LOAD	–	125	–	%
AUDIO REJECTION ¹	SINGLES AND DUALS	–	40	–	dB
	TRIPLES	–	50	–	
CONVERSION FREQUENCY FREE RUN -55° TO +125°C	SINGLES AND DUALS	550	–	650	kHz
	TRIPLES	525	–	650	
SYNCHRONIZATION	INPUT FREQUENCY				
	SINGLES AND DUALS	500	–	675	kHz
	TRIPLES	500	–	700	
	DUTY CYCLE ¹	40	–	60	%
	ACTIVE LOW	–	–	0.8	V
	ACTIVE HIGH ¹	4.5	–	5.0	
	REFERENCED TO	INPUT COMMON			
IF NOT USED	CONNECT TO INPUT COMMON				
INHIBIT ACTIVE LOW (OUTPUT DISABLED)	INHIBIT PIN PULLED LOW	–	–	0.8	V
Do not apply a voltage to the inhibit pin. ³	INHIBIT PIN SOURCE CURRENT ¹				
	SINGLES AND DUALS	–	–	6	mA
	TRIPLES	–	–	8	
REFERENCED TO	INPUT COMMON				
INHIBIT ACTIVE HIGH (OUTPUT ENABLED)	INHIBIT PIN CONDITION	OPEN COLLECTOR OR UNCONNECTED			
Do not apply a voltage to the inhibit pin. ³	OPEN INHIBIT PIN VOLTAGE ¹	9	–	11	V

Notes:

1. Guaranteed by design and/or analysis. Not an in-line test.
2. Dual and triple outputs: The over-current limit will trigger when the sum of the currents from both dual outputs or both auxiliary outputs (triple) reaches 125% (typical value) of the maximum rated "total" current of both outputs.
3. An external inhibit interface should be used to pull the inhibit low or leave it floating. The inhibit pin can be left unconnected if not used.

MTR (40) Single, Dual and Triple DC-DC Converters

28 (16-40) VOLT INPUT – 30 WATT

TABLE 6: ELECTRICAL CHARACTERISTICS: -55°C TO +125°C T_C, 28 VDC V_{IN}, 100% LOAD, FREE RUN, UNLESS OTHERWISE SPECIFIED.

SINGLE OUTPUT MODELS		MTR283R3S			MTR2805S			MTR2812S			UNITS
PARAMETER	CONDITIONS	MIN	TYP	MAX	MIN	TYP	MAX	MIN	TYP	MAX	
OUTPUT VOLTAGE		3.201	3.30	3.399	4.85	5.00	5.15	11.64	12.00	12.36	VDC
OUTPUT CURRENT	V _{in} = 16 to 40 VDC	0	—	6.06	0	—	5.0	0	—	2.5	A
OUTPUT POWER	V _{in} = 16 to 40 VDC	0	—	20	0	—	25	0	—	30	W
OUTPUT RIPPLE	T _C = 25°C	—	15	40	—	35	50	—	25	40	mV p-p
10 kHz - 2 MHz	T _C = -55°C TO +125°C	—	—	50	—	50	90	—	40	90	
LINE REGULATION ²	V _{IN} = 16 TO 40 VDC	—	—	10	—	15	50	—	15	50	mV
LOAD REGULATION	NO LOAD TO FULL	—	—	10	—	15	50	—	15	50	mV
INPUT VOLTAGE	CONTINUOUS	16	28	40	16	28	40	16	28	40	VDC
NO LOAD TO FULL	TRANSIENT 50 msec.	—	—	50	—	—	50	—	—	50	V
INPUT CURRENT	NO LOAD	—	30	75	—	35	75	—	35	75	mA
	INHIBITED	—	7	8	—	3	8	—	3	8	
INPUT RIPPLE CURRENT ³	10 kHz - 10 MHz	—	25	50	—	20	50	—	20	50	mA p-p
EFFICIENCY	T _C = 25°C	74	76	—	76	78	—	80	83	—	%
	T _C = -55°C TO +125°C	71	—	—	73	—	—	77	—	—	
LOAD FAULT ⁴	POWER DISSIPATION	—	—	12	—	—	12	—	—	12	W
SHORT CIRCUIT	RECOVERY ¹	—	1.4	6	—	1.4	5	—	1.4	5	ms
STEP LOAD RESPONSE	TRANSIENT	—	±125	±250	—	±200	±300	—	±250	±400	mV pk
50% - 100% - 50%	RECOVERY ^{1, 5}	—	—	200	—	60	200	—	60	200	μs
STEP LINE RESPONSE	TRANSIENT	—	—	±300	—	±200	±300	—	±400	±500	mV pk
16 - 40 - 16 VDC	RECOVERY ⁵	—	—	300	—	—	300	—	—	300	μs
START-UP ⁶	DELAY	—	1.4	5	—	1.4	5	—	1.4	5	m sec
FULL LOAD	OVERSHOOT ¹	—	0	50	—	0	50	—	0	120	mV pk
CAPACITIVE LOAD ¹	NO EFFECT ON DC PERFORMANCE	—	—	300	—	—	300	—	—	300	μF
	T _C = 25°C										

Notes

1. Guaranteed by design and/or analysis. Not an in-line test.
2. Operation is limited below 16V (see "Figure 27" on page 17).
3. Tested with 6800 pF ceramic bypass capacitor connected externally from input common to case.

4. Indefinite short circuit protection not guaranteed above 125°C case.
5. Recovery time is measured from application of the transient to point at which V_{OUT} is within 1% of final value.
6. Tested on release from inhibit.

MTR (40) Single, Dual and Triple DC-DC Converters

28 (16-40) VOLT INPUT – 30 WATT

TABLE 7: ELECTRICAL CHARACTERISTICS: -55°C TO +125°C T_C, 28 VDC V_{IN}, 100% LOAD, FREE RUN, UNLESS OTHERWISE SPECIFIED.

SINGLE OUTPUT MODELS		MTR2815S			MTR2818S			UNITS
PARAMETER	CONDITIONS	MIN	TYP	MAX	MIN	TYP	MAX	
OUTPUT VOLTAGE		14.70	15.00	15.30	17.46	18.00	18.54	VDC
OUTPUT CURRENT	V _{in} = 16 to 40 VDC	0	—	2.0	0	—	1.67	A
OUTPUT POWER	V _{in} = 16 to 40 VDC	0	—	30	0	—	30	W
OUTPUT RIPPLE 10 kHz - 2 MHz	T _C = 25°C	—	25	40	—	—	40	mV p-p
	T _C = -55°C TO +125°C	—	40	90	—	—	90	
LINE REGULATION ²	V _{IN} = 16 TO 40 VDC	—	15	50	—	—	50	mV
LOAD REGULATION	NO LOAD TO FULL	—	15	50	—	—	50	mV
INPUT VOLTAGE NO LOAD TO FULL	CONTINUOUS	16	28	40	16	28	40	VDC
	TRANSIENT 50 msec.	—	—	50	—	—	50	V
INPUT CURRENT	NO LOAD	—	35	75	—	—	75	mA
	INHIBITED	—	3	8	—	—	8	
INPUT RIPPLE CURRENT ³	10 kHz - 10 MHz	—	20	50	—	—	50	mA p-p
EFFICIENCY	T _C = 25°C	81	84	—	81	84	—	%
	T _C = -55°C TO +125°C	78	—	—	78	—	—	
LOAD FAULT ⁴	POWER DISSIPATION	—	—	12	—	—	12	W
SHORT CIRCUIT	RECOVERY ¹	—	1.4	5	—	1.4	5	ms
STEP LOAD RESPONSE 50% - 100% - 50%	TRANSIENT	—	±350	±500	—	—	±600	mV pk
	RECOVERY ^{1, 5}	—	60	200	—	60	200	μs
STEP LINE RESPONSE 16 - 40 -16 VDC	TRANSIENT	—	±500	±600	—	±500	±800	mV pk
	RECOVERY ⁵	—	—	300	—	—	300	μs
START-UP ⁶	DELAY	—	1.4	5	—	—	5	m sec
FULL LOAD	OVERSHOOT ¹	—	0	150	—	0	180	mV pk
CAPACITIVE LOAD ¹ T _C = 25°C	NO EFFECT ON DC PERFORMANCE	—	—	300	—	—	300	μF

Notes

1. Guaranteed by design and/or analysis. Not an in-line test.
2. Operation is limited below 16V (see "Figure 27" on page 17).
3. Tested with 6800 pF ceramic bypass capacitor connected externally from input common to case.

4. Indefinite short circuit protection not guaranteed above 125°C case.
5. Recovery time is measured from application of the transient to point at which V_{OUT} is within 1% of final value.
6. Tested on release from inhibit.

MTR (40) Single, Dual and Triple DC-DC Converters

28 (16-40) VOLT INPUT – 30 WATT

TABLE 8: ELECTRICAL CHARACTERISTICS: -55°C TO +125°C T_C, 28 VDC V_{IN}, 100% LOAD, FREE RUN, UNLESS OTHERWISE SPECIFIED.

DUAL OUTPUT MODELS - /883 ONLY		MTR2805D			MTR2812D			MTR2815D			UNITS
PARAMETER	CONDITIONS	MIN	TYP	MAX	MIN	TYP	MAX	MIN	TYP	MAX	
OUTPUT VOLTAGE	+ V _{OUT}	4.850	5.00	5.150	11.64	12.00	12.36	14.55	15.00	15.45	VDC
	- V _{OUT}	4.825	5.00	5.172	11.58	12.00	12.42	14.47	15.00	15.53	
OUTPUT CURRENT ² V _{IN} = 16 TO 40 VDC	EITHER OUTPUT	0	2.5	4.5 ¹	0	1.25	2.25 ¹	0	1.00	1.80 ¹	A
	TOTAL OUTPUT	—	—	5	—	—	2.5	—	—	2.00	
OUTPUT POWER ² V _{IN} = 16 to 40 VDC	EITHER OUTPUT	0	12.5	22.5 ¹	0	15	27 ¹	0	15	27 ¹	W
	TOTAL OUTPUT	—	—	25	—	—	30	—	—	30	
OUTPUT RIPPLE 10 kHz - 2 MHz ± V _{OUT}	T _C = 25°C	—	20	80	—	30	80	—	25	80	mV p-p
	T _C = -55°C TO +125°C	—	40	90	—	40	120	—	40	120	
LINE REGULATION ³ V _{IN} = 16 TO 40 VDC	+ V _{OUT}	—	10	50	—	10	50	—	10	50	mV
	- V _{OUT}	—	50	100	—	50	150	—	50	180	
LOAD REGULATION NO LOAD TO FULL	+ V _{OUT}	—	5	50	—	15	50	—	15	50	mV
	- V _{OUT}	—	25	100	—	30	150	—	30	180	
CROSS REGULATION ¹	SEE NOTE 4	—	4	6	—	4	6	—	4	6	%
EFFECT ON -V _{OUT} , 25°C	SEE NOTE 5	—	7	12	—	4	8.3	—	3	8	
INPUT VOLTAGE NO LOAD TO FULL	CONTINUOUS	16	28	40	16	28	40	16	28	40	VDC
	TRANSIENT 50 msec. ¹	0	—	50	0	—	50	0	—	50	
INPUT CURRENT	NO LOAD	—	35	75	—	50	75	—	50	75	mA
	INHIBITED	—	3	8	—	3	8	—	3	8	
INPUT RIPPLE CURRENT ⁶	10 kHz - 10 MHz	—	15	50	—	20	50	—	20	50	mA p-p
EFFICIENCY BALANCED LOAD	T _C = 25°C	76	78	—	79	81	—	80	83	—	%
	T _C = -55°C TO +125°C	73	—	—	76	—	—	77	—	—	
LOAD FAULT ⁷	POWER DISSIPATION	—	10	12	—	10	12	—	10	12	W
SHORT CIRCUIT	RECOVERY ¹	—	1.4	5.0	—	1.4	5.0	—	1.4	5.0	ms
STEP LOAD RESPONSE 50% - 100% - 50% ± V _{OUT}	TRANSIENT	—	±200	±300	—	±150	±300	—	±200	±400	mV pk
	RECOVERY ^{1, 8}	—	100	200	—	100	200	—	100	200	μs
STEP LINE RESPONSE ¹ 16 - 40 -16 VDC ± V _{OUT}	TRANSIENT	—	±200	±400	—	±200	±400	—	±400	±500	mV pk
	RECOVERY ⁸	—	—	300	—	—	300	—	—	300	μs
START-UP ⁹	DELAY	—	1.4	5	—	1.4	5	—	1.4	5	ms
FULL LOAD	OVERSHOOT ¹	—	0	180	—	0	120	—	0	150	mV pk
CAPACITIVE LOAD ¹ T _C = 25°C	NO EFFECT ON DC PERFORMANCE	—	—	500	—	—	500	—	—	500	μF

Notes

- Guaranteed by design and/or analysis. Not an in-line test.
- Up to 90% of the total output current/power is available from either output providing the positive output is carrying at least 10% of the total output power.
- Operation is limited below 16 V ("Figure 27" on page 17).
- Effect on negative V_{OUT} from 50%/50% loads to 80%/20% or 20%/80% loads.
- Effect on negative V_{OUT} from 50%/50% loads to 90%/10% or 10%/90% loads. See Figure 20.

- Tested with 6800 pF ceramic bypass capacitor connected externally from input common to case.
- Indefinite short circuit protection not guaranteed above 125°C case.
- Recovery time is measured from application of the transient to point at which V_{OUT} is within 1% of final value.
- Tested on release from inhibit.

MTR (40) Single, Dual and Triple DC-DC Converters

28 (16-40) VOLT INPUT – 30 WATT

TABLE 9: ELECTRICAL CHARACTERISTICS: -55°C TO +125°C T_C, 28 VDC V_{IN}, 100% LOAD, FREE RUN, UNLESS OTHERWISE SPECIFIED.

DUAL OUTPUT MODELS - STANDARD AND /ES		MTR2805D ²			MTR2812D			MTR2815D			UNITS
PARAMETER	CONDITIONS	MIN	TYP	MAX	MIN	TYP	MAX	MIN	TYP	MAX	
OUTPUT VOLTAGE	+ V _{OUT}	4.850	5.00	5.150	11.88	12.00	12.12	14.85	15.00	15.15	VDC
	- V _{OUT}	4.825	5.00	5.172	11.58	12.00	12.42	14.47	15.00	15.53	
OUTPUT CURRENT ³ V _{IN} = 16 TO 40 VDC	EITHER OUTPUT	0	2.5	4.5 ¹	0	1.25	2.25 ¹	0	1.00	1.80 ¹	A
	TOTAL OUTPUT	—	—	5	—	—	2.5	—	—	2.00	
OUTPUT POWER ³ V _{IN} = 16 TO 40 VDC	EITHER OUTPUT	0	12.5	22.5 ¹	0	15	27 ¹	0	15	27 ¹	W
	TOTAL OUTPUT	—	—	25	—	—	30	—	—	30	
OUTPUT RIPPLE 10 kHz - 2 MHz ± V _{OUT}	T _C = 25°C	—	20	80	—	30	80	—	25	80	mV p-p
	T _C = -55°C TO +125°C	—	—	—	—	40	120	—	40	120	
LINE REGULATION ⁴ V _{IN} = 16 TO 40 VDC	+ V _{OUT}	—	10	50	—	10	50	—	10	50	mV
	- V _{OUT}	—	50	100	—	50	150	—	50	180	
LOAD REGULATION NO LOAD TO FULL	+ V _{OUT}	—	5	50	—	15	50	—	15	50	mV
	- V _{OUT}	—	25	100	—	30	150	—	30	180	
CROSS REGULATION ¹ EFFECT ON -V _{OUT} , 25°C	SEE NOTE 5	—	4	6	—	4	6	—	4	6	%
	SEE NOTE 6	—	7	12	—	4	8.3	—	3	8	
INPUT VOLTAGE NO LOAD TO FULL	CONTINUOUS	16	28	40	16	28	40	16	28	40	VDC
	TRANSIENT 50 msec. ¹	0	—	50	0	—	50	0	—	50	V
INPUT CURRENT	NO LOAD	—	35	50	—	50	75	—	50	75	mA
	INHIBITED	—	3	8	—	3	8	—	3	8	
INPUT RIPPLE CURRENT ⁷	10 kHz - 10 MHz	—	15	40	—	20	50	—	20	50	mA p-p
EFFICIENCY BALANCED LOAD	T _C = 25°C	76	78	—	78	81	—	80	83	—	%
	T _C = -55°C TO +125°C	—	—	—	76	—	—	77	—	—	
LOAD FAULT ⁸	POWER DISSIPATION	—	10	12	—	10	12	—	10	12	W
SHORT CIRCUIT	RECOVERY ¹	—	1.4	5.0	—	1.4	5.0	—	1.4	5.0	ms
STEP LOAD RESPONSE 50% - 100% - 50% ± V _{OUT}	TRANSIENT	—	±200	±300	—	±150	±300	—	±200	±400	mV pk
	RECOVERY ^{1, 9}	—	100	200	—	100	200	—	100	200	μs
STEP LINE RESPONSE ¹ 16 - 40 - 16 VDC ± V _{OUT}	TRANSIENT ⁹	—	±200	±400	—	±200	±400	—	±400	±500	mV pk
	RECOVERY ⁹	—	—	300	—	—	300	—	—	300	μs
START-UP ¹⁰	DELAY	—	1.4	5	—	1.4	5	—	1.4	5	ms
FULL LOAD	OVERSHOOT ¹	—	0	180	—	0	120	—	0	150	mV pk
CAPACITIVE LOAD ¹ T _C = 25°C	NO EFFECT ON DC PERFORMANCE	—	—	500	—	—	500	—	—	500	μF

Notes

- Guaranteed by design and/or analysis. Not an in-line test.
- MTR2805D (standard and /ES) is specified at 25°C only.
- Up to 90% of the total output current/power is available from either output providing the positive output is carrying at least 10% of the total output power.
- Operation is limited below 16 V. See "Figure 27" on page 17.
- Effect on negative V_{OUT} from 50%/50% loads to 80%/20% or 20%/80% loads.
- Effect on negative V_{OUT} from 50%/50% loads to 90%/10% or 10%/90% loads. See "Figure 25" on page 17.
- Tested with 6800 pF ceramic bypass capacitor connected externally from input common to case.
- Indefinite short circuit protection not guaranteed above 125°C case.
- Recovery time is measured from application of the transient to point at which V_{OUT} is within 1% of final value.
- Tested on release from inhibit.

MTR (40) Single, Dual and Triple DC-DC Converters

28 (16-40) VOLT INPUT – 30 WATT

TABLE 10: ELECTRICAL CHARACTERISTICS: -55°C TO +125°C T_C, 28 VDC V_{IN}, 100% LOAD, FREE RUN, UNLESS OTHERWISE SPECIFIED.

TRIPLE OUTPUT MODEL – MTR28512T		5 (MAIN)			±12 (AUXILIARIES)			UNITS
PARAMETER	CONDITIONS	MIN	TYP	MAX	MIN	TYP	MAX	
OUTPUT VOLTAGE		4.85	5.00	5.15	±11.58	12.00	±12.42	VDC
OUTPUT CURRENT ²		0.3	—	4.0	0	±0.416	0.750 ¹	A
V _{IN} = 16 to 40 VDC	TOTAL	—	—	—	—	—	0.833	
OUTPUT POWER ²		0	—	20	0	±5	9.00 ¹	W
V _{IN} = 16 to 40 VDC	TOTAL	—	—	—	—	—	10	
OUTPUT RIPPLE	T _C = 25°C	—	50	125	—	20	60	mV p-p
10 kHz - 2 MHz	T _C = -55°C TO +125°C	—	—	180	—	—	60	
LINE REGULATION	V _{IN} = 16 to 40 VDC	—	10	20	—	25	75	mV
LOAD REGULATION ^{3, 4}		—	10	50	—	30	75	mV
INPUT VOLTAGE	CONTINUOUS	16	28	40	—	—	—	VDC
	TRANSIENT 50 ms ¹	—	—	50	—	—	—	V
INPUT CURRENT	NO LOAD	—	70	110	—	—	—	mA
	INHIBITED	—	3.0	6	—	—	—	
INPUT RIPPLE CURRENT	10 kHz - 10 MHz	—	20	80	—	—	—	mA p-p
EFFICIENCY	T _C = 25°C	72	75	—	—	—	—	%
	T _C = -55°C TO +125°C	70	—	—	—	—	—	
LOAD FAULT ⁵	POWER DISSIPATION	—	—	14	—	—	14	W
ALL OUTPUTS SHORTED	RECOVERY ¹	—	4	6.0	—	4	6.0	ms
STEP LOAD RESPONSE	TRANSIENT ⁶	—	—	±400	—	—	±1500	mV pk
	RECOVERY ⁷	—	—	0.300	—	—	6	ms
STEP LINE RESPONSE ¹	TRANSIENT	—	—	±800	—	—	±800	mV pk
16 - 40 - 16 V _{IN}	RECOVERY ⁷	—	—	5	—	—	5	ms
START-UP ⁸	DELAY	—	4	6.0	—	4	6.0	ms
	OVERSHOOT ¹	—	—	500	—	—	1500	mV pk

Notes

1. Guaranteed by design and/or analysis. Not an in-line test.
2. The sum of the two aux outputs is not to exceed 10 watts. The maximum load per aux output is 9 watts.
3. To maintain regulation when operating the ±aux at full load, a minimum load of 300 mA is required on the main.
4. Measured on each output one at a time with the other outputs at full load.
5. Indefinite short circuit protection not guaranteed above 125°C (case).

6. Response of each output as all outputs are simultaneously transitioned.
Main: 50% - 100% - 50% of main full load
Auxiliaries: 25% - 50% - 25% each, of total auxiliary full load
7. Recovery time is measured from application of the transient to point at which V_{OUT} is within 1% of regulation.
8. Tested on release from inhibit.

MTR (40) Single, Dual and Triple DC-DC Converters

28 (16-40) VOLT INPUT – 30 WATT

TABLE 11: ELECTRICAL CHARACTERISTICS: -55°C TO +125°C T_C, 28 VDC V_{IN}, 100% LOAD, FREE RUN, UNLESS OTHERWISE SPECIFIED.

TRIPLE OUTPUT MODEL – MTR28515T		5 (MAIN)			±15 (AUXILIARIES)			UNITS
PARAMETER	CONDITIONS	MIN	TYP	MAX	MIN	TYP	MAX	
OUTPUT VOLTAGE		4.85	5.00	5.15	±14.47	15.00	±15.52	VDC
OUTPUT CURRENT ²		0.3	—	4.0	0	±0.333	0.600 ¹	A
V _{IN} = 16 to 40 VDC	TOTAL	—	—	—	—	—	0.666	
OUTPUT POWER ²		0	—	20	0	±5	9.00 ¹	W
V _{IN} = 16 to 40 VDC	TOTAL	—	—	—	—	—	10	
OUTPUT RIPPLE	T _C = 25°C	—	50	125	—	20	60	mV p-p
10 kHz - 2 MHz	T _C = -55°C TO +125°C	—	—	180	—	—	60	
LINE REGULATION	V _{IN} = 16 to 40 VDC	—	10	20	—	30	75	mV
LOAD REGULATION ^{3, 4}		—	10	50	—	30	75	mV
INPUT VOLTAGE	CONTINUOUS	16	28	40	—	—	—	VDC
	TRANSIENT 50 ms ¹	—	—	50	—	—	—	V
INPUT CURRENT	NO LOAD	—	70	120	—	—	—	mA
	INHIBITED	—	3.0	6	—	—	—	
INPUT RIPPLE CURRENT	10 kHz - 10 MHz	—	20	80	—	—	—	mA p-p
EFFICIENCY	T _C = 25°C	73	75	—	—	—	—	%
	T _C = -55°C TO +125°C	71	—	—	—	—	—	
LOAD FAULT ⁵	POWER DISSIPATION	—	—	14	—	—	14	W
ALL OUTPUTS SHORTED	RECOVERY ¹	—	4	6.0	—	4	6.0	ms
STEP LOAD RESPONSE	TRANSIENT ⁶	—	—	±400	—	—	±1500	mV pk
	RECOVERY ⁷	—	—	0.300	—	—	6	ms
STEP LINE RESPONSE ¹	TRANSIENT	—	—	±800	—	—	±800	mV pk
16 - 40 - 16 V _{IN}	RECOVERY ⁷	—	—	5	—	—	5	ms
START-UP ⁸	DELAY	—	4	6.0	—	4	6.0	ms
	OVERSHOOT ¹	—	—	500	—	—	1500	mV pk

Notes

- Guaranteed by design and/or analysis. Not an in-line test.
- The sum of the two aux outputs is not to exceed 10 watts. The maximum load per aux output is 9 watts.
- To maintain regulation when operating the ±aux at full load, a minimum load of 300 mA is required on the main.
- Measured on each output one at a time with the other outputs at full load.
- Indefinite short circuit protection not guaranteed above 125°C (case).
- Response of each output as all outputs are simultaneously transitioned.
Main: 50% - 100% - 50% of main full load
Auxiliaries: 25% - 50% - 25% each, of total auxiliary full load
- Recovery time is measured from application of the transient to point at which V_{OUT} is within 1% of regulation.
- Tested on release from inhibit.

MTR (40) Single, Dual and Triple DC-DC Converters

28 (16-40) VOLT INPUT – 30 WATT

Typical Performance Curves: 25°C Tc, 28 VDC Vin, 100% load, free run, unless otherwise specified.

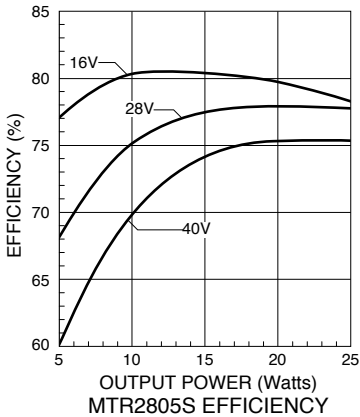

FIGURE 12

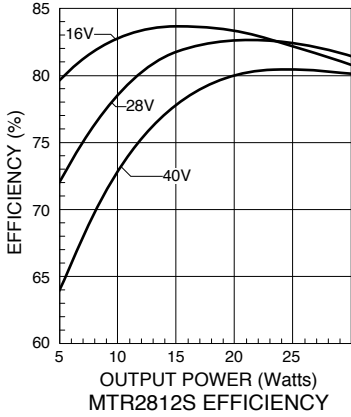

FIGURE 13

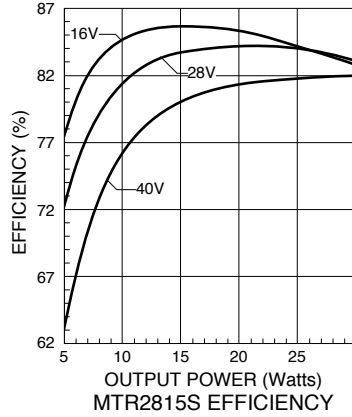

FIGURE 14

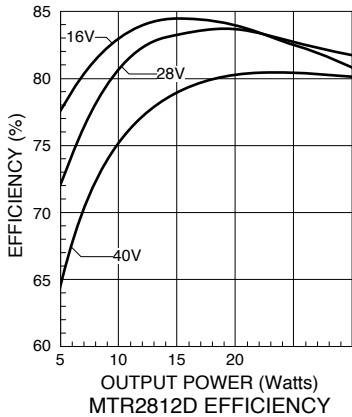

FIGURE 15

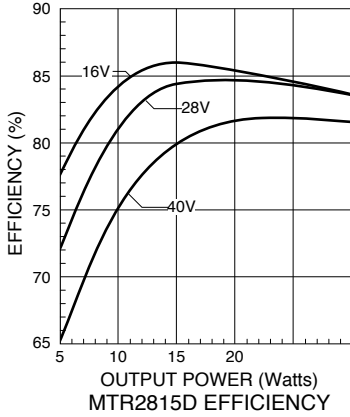

FIGURE 16

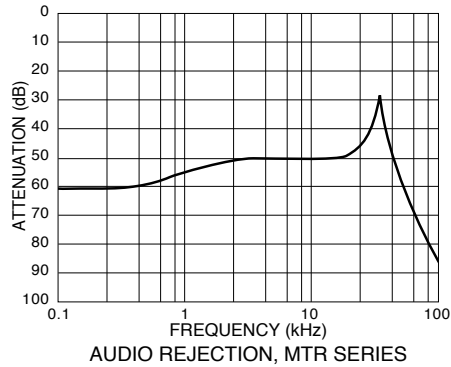
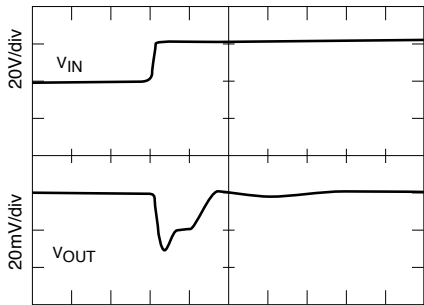
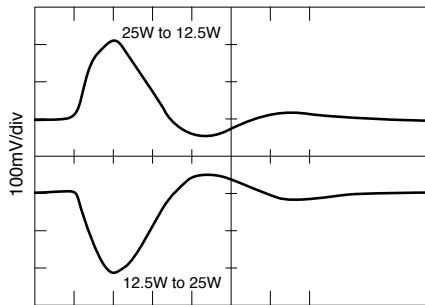

FIGURE 14



MTR2805S STEP LINE RESPONSE

FIGURE 17



MTR2805S STEP LOAD RESPONSE

FIGURE 18

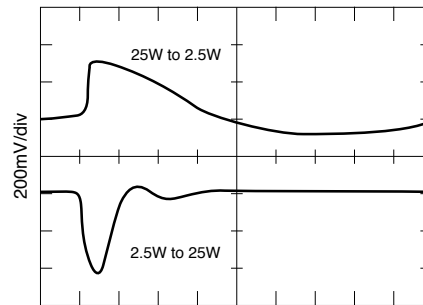

MTR2805S STEP LOAD RESPONSE

FIGURE 19

MTR (40) Single, Dual and Triple DC-DC Converters

28 (16-40) VOLT INPUT – 30 WATT

Typical Performance Curves: 25°C Tc, 28 VDC Vin, 100% load, free run, unless otherwise specified.

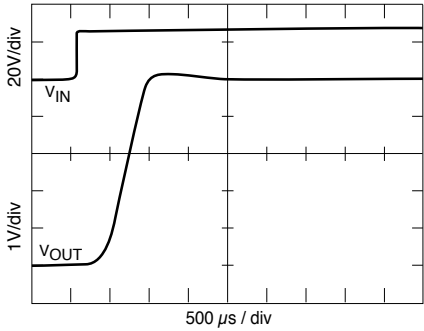

MTR2805S TURN-ON INTO NO LOAD

FIGURE 20

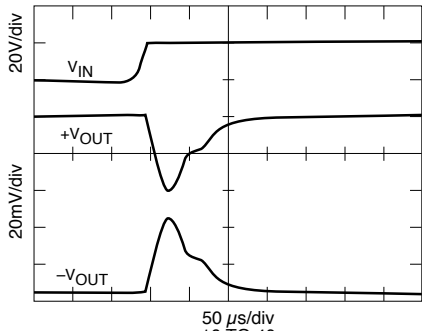

MTR2815D STEP LINE RESPONSE

FIGURE 21

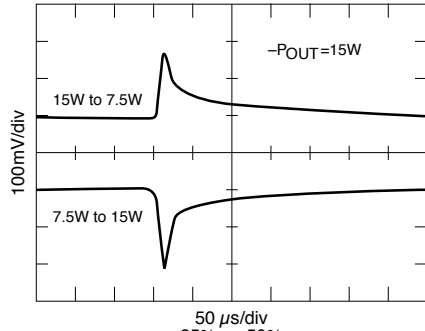

MTR2815D +VOUT STEP LOAD RESPONSE

FIGURE 22

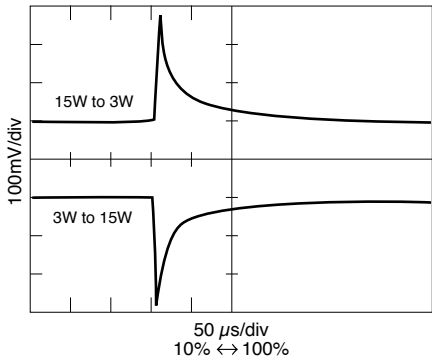

MTR2815D +VOUT STEP LOAD RESPONSE

FIGURE 23

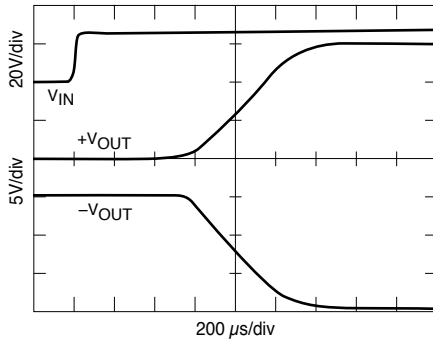

MTR2815D TURN-ON INTO NO LOAD

FIGURE 24

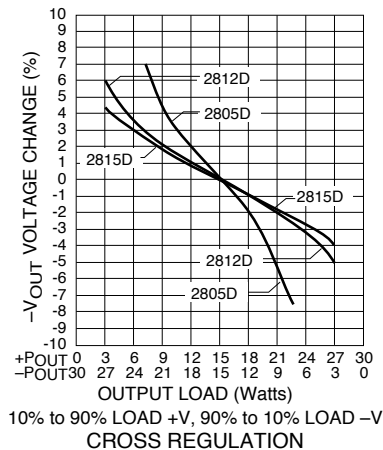

10% to 90% LOAD +V, 90% to 10% LOAD -V
CROSS REGULATION

FIGURE 25

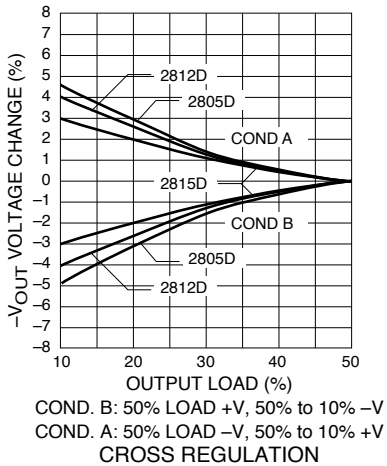

COND. B: 50% LOAD +V, 50% to 10% -V
COND. A: 50% LOAD -V, 50% to 10% +V
CROSS REGULATION

FIGURE 26

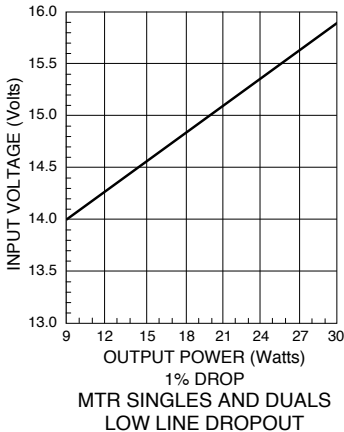

MTR SINGLES AND DUALS
LOW LINE DROPOUT

FIGURE 27

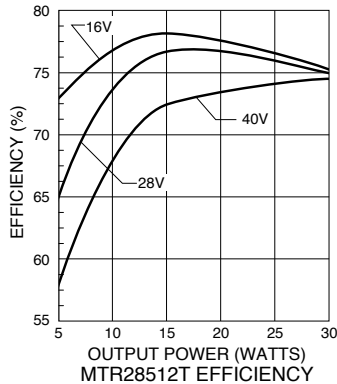

MTR28512T EFFICIENCY

FIGURE 28

MTR (40) Single, Dual and Triple DC-DC Converters

28 (16-40) VOLT INPUT – 30 WATT

Typical Performance Curves: 25°C Tc, 28 VDC Vin, 100% load, free run, unless otherwise specified.

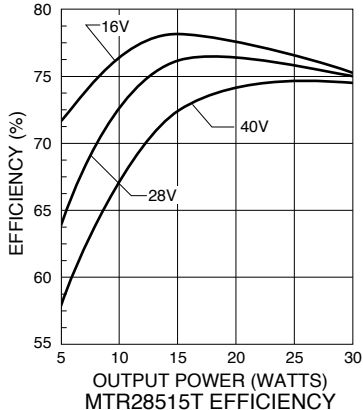

FIGURE 29

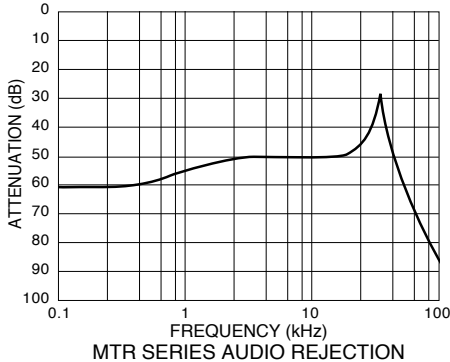

FIGURE 30

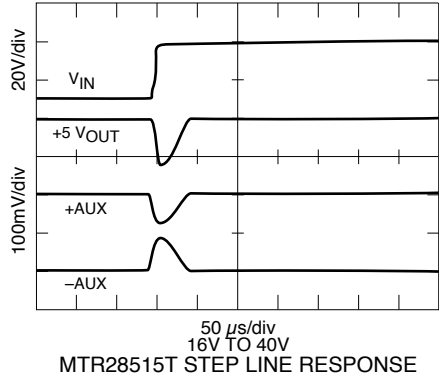
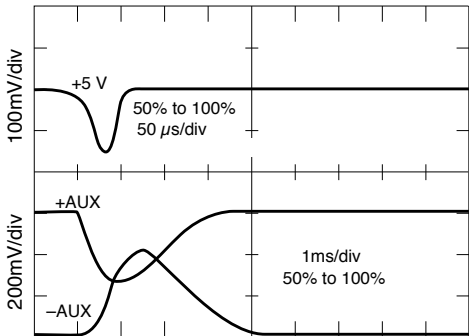
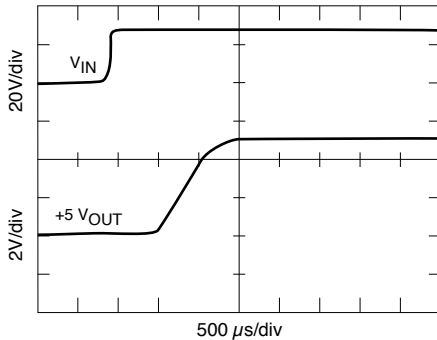

FIGURE 31



50% ↔ 100%
MTR28515T STEP LOAD RESPONSE

FIGURE 32



MTR28515T, MAIN (+5)
TURN-ON INTO FULL LOAD

FIGURE 33

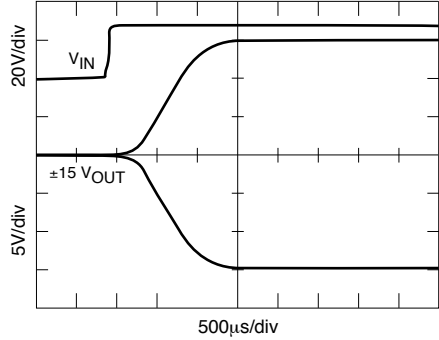

MTR28515T, AUX. (±15)
TURN-ON INTO FULL LOAD

FIGURE 34

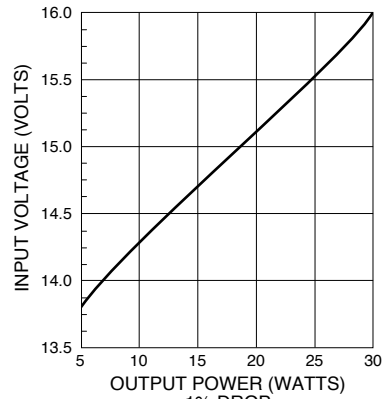

FIGURE 35

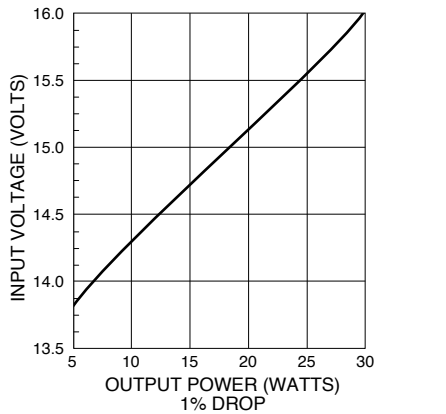
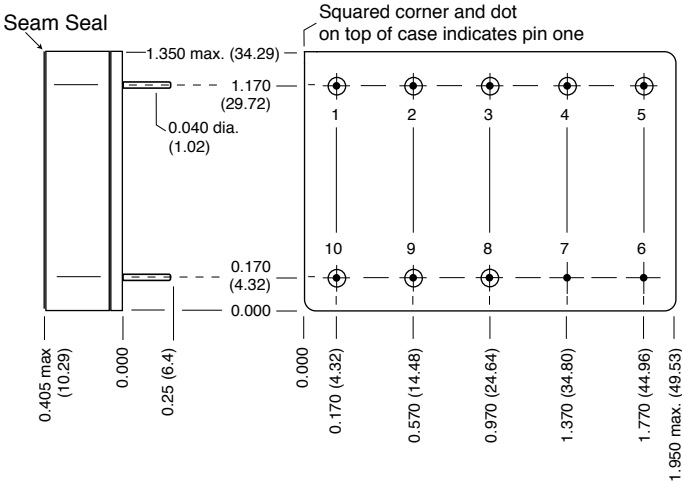

FIGURE 36

MTR (40) Single, Dual and Triple DC-DC Converters

28 (16-40) VOLT INPUT – 30 WATT

BOTTOM VIEW CASE F1



Weight 58 grams max.

Case dimensions in inches (mm)
 Tolerance ±0.005 (0.13) for three decimal places
 ±0.01 (0.3) for two decimal places
 unless otherwise specified

CAUTION
 Heat from reflow or wave soldering may damage the device.
 Solder pins individually with heat application not exceeding 300°C for 10 seconds per pin.

Materials
 Header Cold Rolled Steel/Nickel/Gold
 Cover Kovar/Nickel
 Pins #52 alloy/Gold ceramic seal
 Gold plating of 50 - 150 microinches included in pin diameter
 Seal hole 0.120 ±0.002 (3.05 ± 0.05)

Case F1 MTR T, Rev G, 2013.07.01
 Please refer to the numerical dimensions for accuracy.

FIGURE 37: CASE F1 – TRIPLE MODELS

MTR (40) Single, Dual and Triple DC-DC Converters

28 (16-40) VOLT INPUT – 30 WATT

BOTTOM VIEW CASE H2

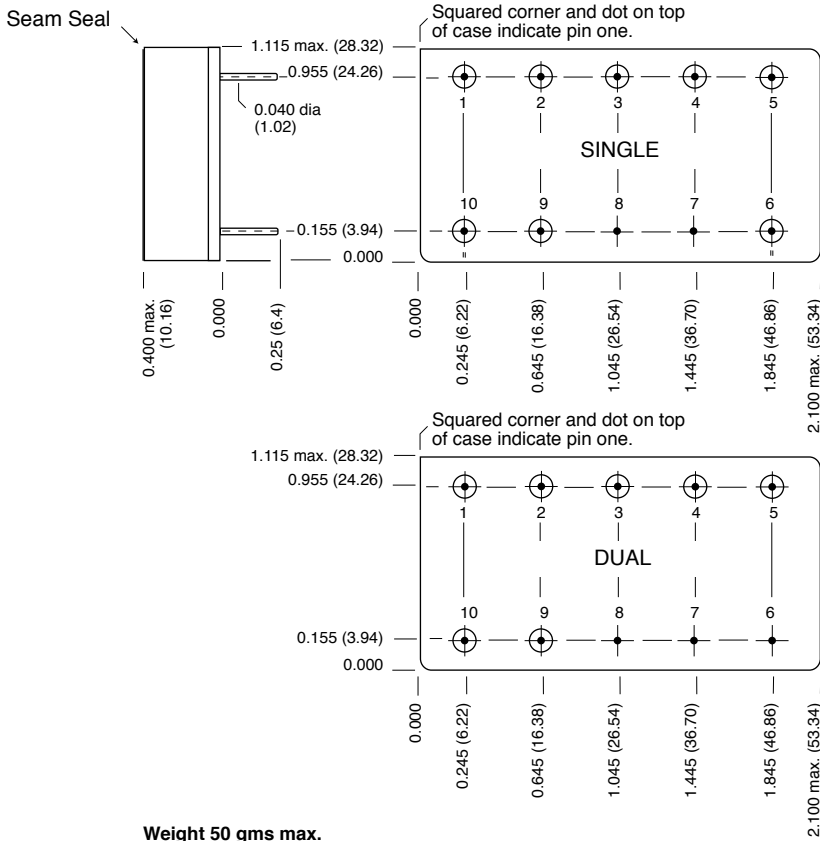

Weight 50 gms max.

Case dimensions in inches (mm)

Tolerance ±0.005 (0.13) for three decimal places
±0.01 (0.3) for two decimal places
unless otherwise specified

CAUTION

Heat from reflow or wave soldering may damage the device.
Solder pins individually with heat application not exceeding 300°C for 10 seconds per pin.

Materials

- Header Cold Rolled Steel/Nickel/Gold
- Cover Kovar/Nickel
- Pins #52 alloy/Gold ceramic seal
Gold plating of 50 - 150 microinches included in pin diameter
Seal hole 0.120 ±0.002 (3.05 ± 0.05)

Case H2 MTR SD, Rev J, 2013.07.01
Please refer to the numerical dimensions for accuracy..

FIGURE 38: CASE H2 – SINGLE AND 883 DUAL MODELS
APPLIES TO ALL SINGLE MODELS, APPLIES ONLY TO 883 DUAL MODELS,
SEE CASE H4 FOR NON-883 DUAL MODELS

MTR (40) Single, Dual and Triple DC-DC Converters

28 (16-40) VOLT INPUT – 30 WATT

BOTTOM VIEW CASE H4

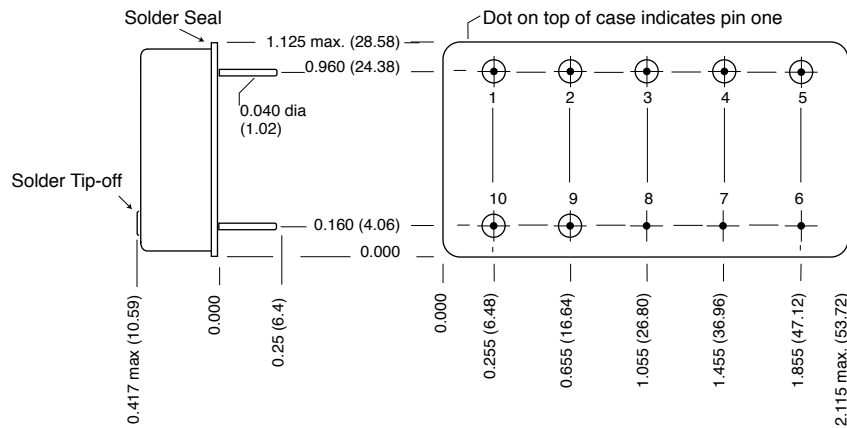

Weight 50 grams max.

Case dimensions in inches (mm)

Tolerance ± 0.005 (0.13) for three decimal places
 ± 0.01 (0.3) for two decimal places
 unless otherwise specified

CAUTION

Heat from reflow or wave soldering may damage the device.
 Solder pins individually with heat application not exceeding 300°C for 10 seconds per pin.

Materials

Header Cold Rolled Steel/Nickel/Tin
 Cover Cold Rolled Steel/Nickel/Tin
 Pins #52 alloy, compression glass seal
 Gold plating of 50 - 150 microinches included in pin diameter
 Seal hole 0.092 ± 0.002 (2.34 ± 0.05)

Case H4 MTR D non-883, Rev F - 2013.07.01
 Please refer to the numerical dimensions for accuracy.

FIGURE 39: CASE H4 – DUAL MODELS - NON 883

MTR (40) Single, Dual and Triple DC-DC Converters

28 (16-40) VOLT INPUT – 30 WATT

BOTTOM VIEW CASE J1

Flanged cases: Designator "F" required in Case Option position of model number.

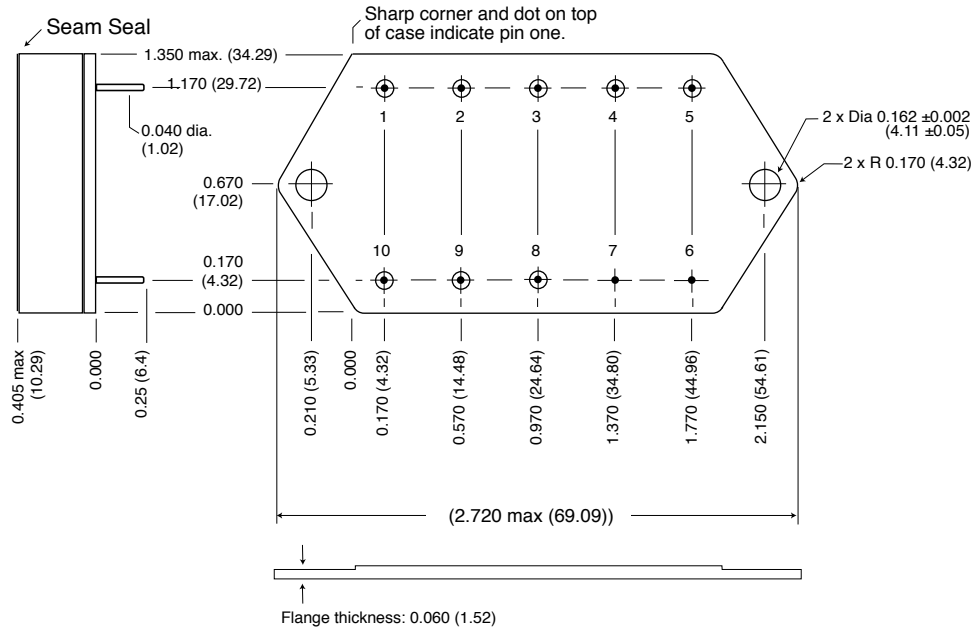

Weight 62 gms max.

Case dimensions in inches (mm)

Tolerance ±0.005 (0.13) for three decimal places
 ±0.01 (0.3) for two decimal places
 unless otherwise specified

CAUTION

Heat from reflow or wave soldering may damage the device. Solder pins individually with heat application not exceeding 300°C for 10 seconds per pin.

Materials

Header Cold Rolled Steel/Nickel/Gold
 Cover Kovar/Nickel
 Pins #52 alloy/Gold ceramic seal
 Gold plating of 50 - 150 microinches included in pin diameter
 Seal Hole: 0.120 ±0.002 (3.04 ±0.05)

Case J1 MTR T F, Rev J, 2013.07.01

Please refer to the numerical dimensions for accuracy.

FIGURE 40: CASE J1 – TRIPLE MODELS

MTR (40) Single, Dual and Triple DC-DC Converters

28 (16-40) VOLT INPUT – 30 WATT

BOTTOM VIEW CASE K3

Flanged cases: Designator "F" required in Case Option position of model number.

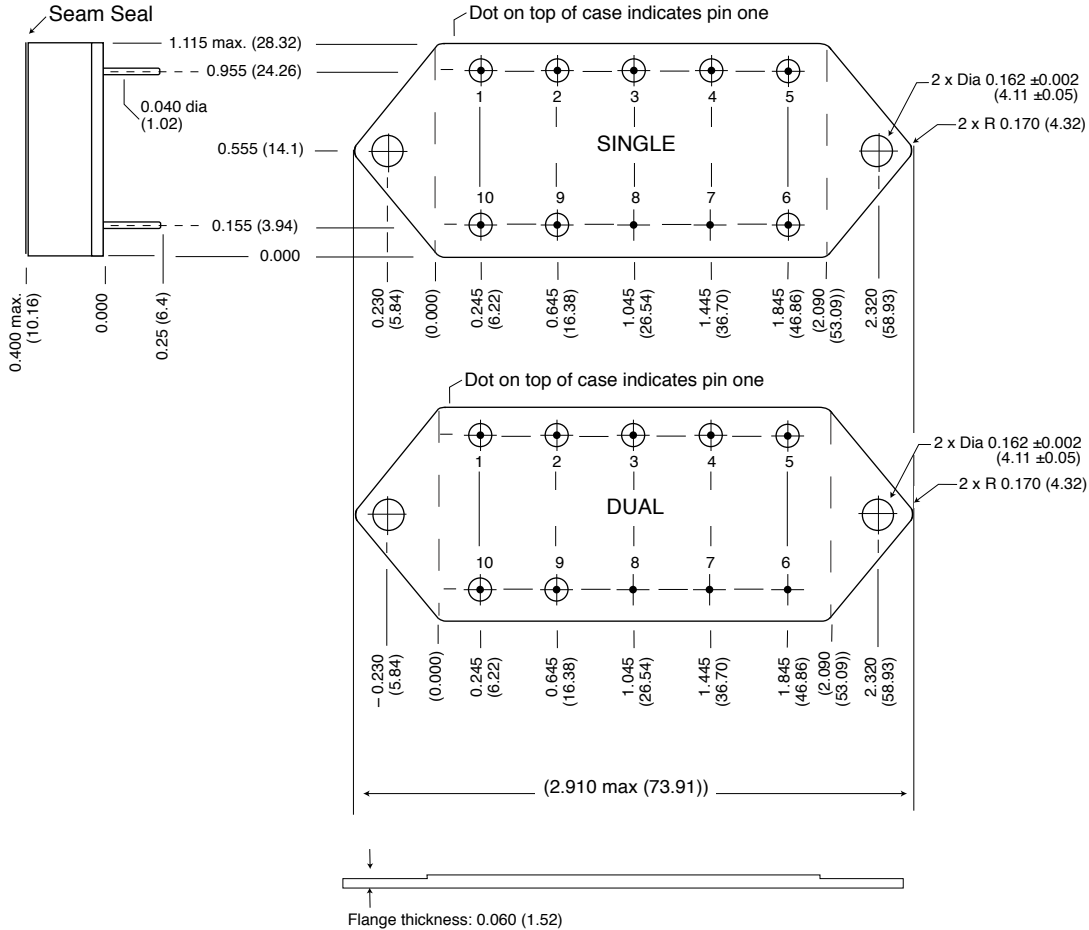

Weight 52 grams max.

Case dimensions in inches (mm)

Tolerance ± 0.005 (0.13) for three decimal places
 ± 0.01 (0.3) for two decimal places
 unless otherwise specified

CAUTION

Heat from reflow or wave soldering may damage the device. Solder pins individually with heat application not exceeding 300°C for 10 seconds per pin.

Materials

- Header Cold Rolled Steel/Nickel/Gold
- Cover Kovar/Nickel
- Pins #52 alloy/Gold, ceramic seal
 Gold plating of 50 - 150 microinches included in pin diameter
 Seal hole 0.120 ± 0.002 (3.04 ± 0.05)

Case K3 MTR SD F, Rev J, 2013.07.01
 Please refer to the numerical dimensions for accuracy.

FIGURE 41: CASE K3 – SINGLE AND DUAL 883 MODELS
 APPLIES TO ALL SINGLE MODELS, APPLIES ONLY TO 883 DUAL MODELS

MTR (40) Single, Dual and Triple DC-DC Converters

28 (16-40) VOLT INPUT – 30 WATT

BOTTOM VIEW CASE K5

Flanged cases: Designator "F" required in Case Option position of model number.

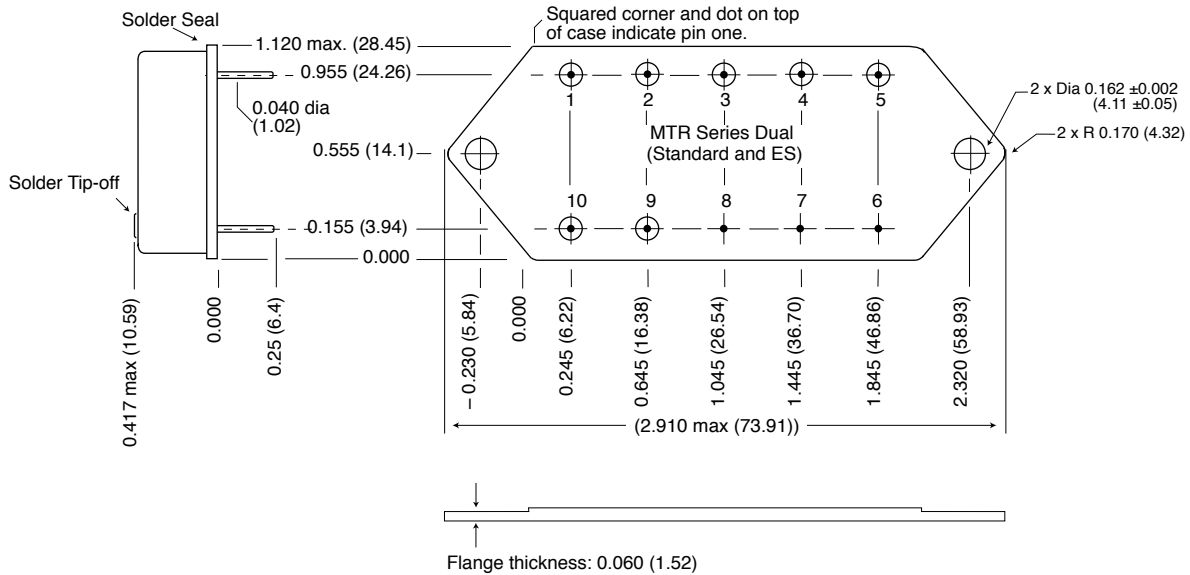

Weight 52 grams max.

Case dimensions in inches (mm)

Tolerance ±0.005 (0.13) for three decimal places
 ±0.01 (0.3) for two decimal places
 unless otherwise specified

CAUTION

Heat from reflow or wave soldering may damage the device.
 Solder pins individually with heat application not exceeding 300°C for 10 seconds per pin.

Materials

Header Cold Rolled Steel/Nickel/Tin
 Cover Cold Rolled Steel/Nickel/Tin
 Pins #52 alloy, compression glass seal
 Gold plating of 50 - 150 microinches included in pin diameter
 Seal hole 0.092 ±0.002 (2.34 ± 0.05)

Case K3 MTR D F non-883, Rev H, 2013.07.01
 Please refer to the numerical dimensions for accuracy.

FIGURE 42: CASE K5 – DUAL MODELS - NON 883

MTR (40) Single, Dual and Triple DC-DC Converters

28 (16-40) VOLT INPUT – 30 WATT

STANDARD AND /ES (NON-QML) AND /883 (CLASS H, QML) MIL-PRF-38534 ELEMENT EVALUATION

COMPONENT-LEVEL TEST PERFORMED	NON-QML ¹	QML	
	STANDARD AND /ES	CLASS H /883	
	M/S ²	M/S ²	P ³
Element Electrical	■	■	■
Visual		■	■
Internal Visual		■	
Final Electrical		■	■
Wire Bond Evaluation		■	■

Notes:

- Standard and /ES non-QML products may not meet all of the requirements of MIL-PRF-38534.
- M/S = Active components (Microcircuit and Semiconductor Die)
- P = Passive components, Class H element evaluation. Not applicable to Standard and /ES element evaluation.

TABLE 12: ELEMENT EVALUATION

MTR (40) Single, Dual and Triple DC-DC Converters

28 (16-40) VOLT INPUT – 30 WATT

STANDARD AND /ES (NON-QML) AND /883 (CLASS H, QML) MIL-PRF-38534 ENVIRONMENTAL SCREENING

TEST PERFORMED	NON-QML ¹		QML
	STANDARD	/ES	CLASS H /883
Pre-cap Inspection, Method 2017, 2032	■	■	■
Temperature Cycle (10 times)			
Method 1010, Cond. C, -65°C to +150°C, ambient			■
Method 1010, Cond. B, -55°C to +125°C, ambient		■	
Constant Acceleration			
Method 2001, 3000 g			■
Method 2001, 500 g		■	
Burn-in Method 1015, +125°C case, typical ²			
96 hours		■	
160 hours			■
Final Electrical Test, MIL-PRF-38534, Group A,			
Subgroups 1 through 6, -55°C, +25°C, +125°C case			■
Subgroups 1 and 4, +25°C case	■	■	■
Hermeticity Test			
Gross Leak, Method 1014, Cond. C		■	■
Fine Leak, Method 1014, Cond. A		■	■
Gross Leak, Dip	■		
Final visual inspection, Method 2009	■	■	■

Test methods are referenced to MIL-STD-883 as determined by MIL-PRF-38534.

Notes:

- Standard and /ES, non-QML products, may not meet all of the requirements of MIL-PRF-38534.
- Burn-in temperature designed to bring the case temperature to +125°C minimum. Burn-in is a powered test.

TABLE 13: ENVIRONMENTAL SCREENING