

# 3.3V 1A Low Dropout Regulator

## Features

- Dropout voltage typically 0.8V @  $I_o = 1A$
- Output current in excess of 1A
- Output voltage accuracy  $\pm 2\%$
- Quiescent current, typically 600 $\mu A$
- Internal short circuit current limit
- Internal over temperature protection

## Applications

- CD-R/W
- ADSL
- Cable Modem
- Set-Top-Box
- LAN switch/Hub
- Router
- DVD-R/W

## General Description

The G960 positive 3.3V voltage regulator features the ability to source 1A of output current with a dropout voltage of typically 0.8V over the entire operating temperature range. A low quiescent current is provided over the entire current output current range. The typical quiescent current is 0.6mA. Furthermore, the quiescent current is smaller when the regulator is in the dropout mode ( $V_{IN} < 3.3V$ ).

Familiar regulator features such as over temperature and over current protection circuits are provided to prevent it from being damaged by abnormal operating conditions.

## Ordering Information

ORDER NUMBER	PACKAGE TYPE	PIN OPTION		
		1	2	3
G960T33T	TO220	GND	$V_{OUT}$	$V_{IN}$
G960T36T	TO220	$V_{IN}$	$V_{OUT}$	GND
G960T43U	TO252	GND	$V_{OUT}$	$V_{IN}$
G960T45U	TO252	$V_{IN}$	GND	$V_{OUT}$
G960T53U	TO263	GND	$V_{OUT}$	$V_{IN}$
G960T63U	SOT223	GND	$V_{OUT}$	$V_{IN}$

## Order Number Identification

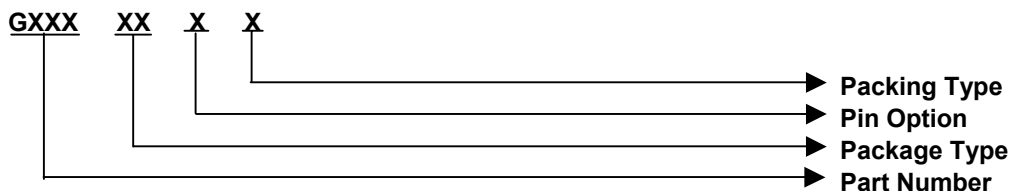

### PACKAGE TYPE

- T3 : TO 220
- T4 : TO 252
- T5 : TO 263
- T6 : SOT 223

### PIN OPTION

- |     |           |           |           |
|-----|-----------|-----------|-----------|
|     | <b>1</b>  | <b>2</b>  | <b>3</b>  |
| 1 : | $V_{OUT}$ | GND       | $V_{IN}$  |
| 2 : | $V_{OUT}$ | $V_{IN}$  | GND       |
| 3 : | GND       | $V_{OUT}$ | $V_{IN}$  |
| 4 : | GND       | $V_{IN}$  | $V_{OUT}$ |
| 5 : | $V_{IN}$  | GND       | $V_{OUT}$ |
| 6 : | $V_{IN}$  | $V_{OUT}$ | GND       |

### PACKING

- U & D : Tape & Reel Direction
- T : Tube

## Typical Application

[Note 4] : Type of  $C_{OUT}$

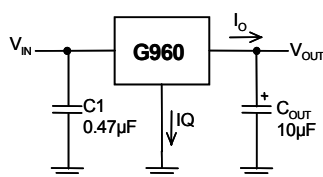

## Package Type

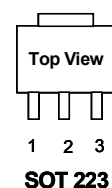
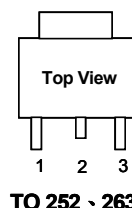
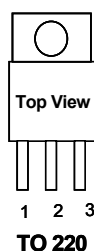

**Absolute Maximum Ratings** (Note 1)

Input Voltage.....	10V
Power Dissipation Internally Limited (Note 2)	
Maximum Junction Temperature.....	150°C
Storage Temperature Range.....	-65°C ≤ T <sub>J</sub> ≤ +150°C
Lead Temperature, Time for Wave Soldering	
TO 220, TO 263 Package.....	260°C, 10s
TO 252, SOT 223 Package.....	260°C, 4s
Continuous Power Dissipation (T <sub>A</sub> = +25°C)	
SOT 223 <sup>(1)</sup> .....	0.8W
TO 252 <sup>(1)</sup> .....	1.0W
TO 263 <sup>(1)</sup> .....	1.6W
TO 220 <sup>(1)</sup> .....	2.0W

Note <sup>(1)</sup>: See Recommended Minimum Footprint

**Operating Conditions** (Note 1)

Input Voltage.....	4V~7V
Temperature Range.....	-40°C ≤ T <sub>J</sub> ≤ 125°C

**Electrical Characteristics**

V<sub>IN</sub> = 5V, I<sub>O</sub> = 1A, C<sub>IN</sub> = 1μF, C<sub>OUT</sub> = 10μF, All specifications apply for T<sub>A</sub> = T<sub>J</sub> = 25°C. [Note 3]

PARAMETER	CONDITIONS	MIN	TYP	MAX	UNITS
Output Voltage	50mA ≤ I <sub>O</sub> ≤ 1A	3.234	3.3	3.366	V
Line Regulation	4V ≤ V <sub>IN</sub> ≤ 7V, I <sub>O</sub> = 10mA		20	30	mV
Load Regulation	50mA ≤ I <sub>O</sub> ≤ 1A		30	50	mV
Output Impedance	200mA DC and 100mA AC, f <sub>o</sub> = 120Hz		100		mΩ
Quiescent Current	V <sub>IN</sub> = 5V		0.6		mA
Ripple Rejection	f <sub>i</sub> = 120Hz, 1V <sub>P-P</sub> , I <sub>O</sub> = 100mA		42		dB
Dropout Voltage	I <sub>O</sub> = 1A		0.8		V
	I <sub>O</sub> = 100mA		200		mV
Short Circuit Current		1.6	1.9		A
Over Temperature			125		°C

**Note 1:** Absolute Maximum Ratings are limits beyond which damage to the device may occur. Operating Conditions are conditions under which the device functions but the specifications might not be guaranteed. For guaranteed specifications and test conditions see the Electrical Characteristics.

**Note2:** The maximum power dissipation is a function of the maximum junction temperature, T<sub>Jmax</sub>; total thermal resistance, θ<sub>JA</sub>, and ambient temperature T<sub>A</sub>. The maximum allowable power dissipation at any ambient temperature is T<sub>Jmax</sub>-T<sub>A</sub>/θ<sub>JA</sub>. If this dissipation is exceeded, the die temperature will rise above 150°C and IC will go into thermal shutdown. For the G960 in the SOT 223 package, θ<sub>JA</sub> is 156°C/W; in the TO 252 package, θ<sub>JA</sub> is 125°C/W; in the TO 263 package, θ<sub>JA</sub> is 75°C/W, and in the TO 220 package, θ<sub>JA</sub> is 60°C/W (No heat sink). [See Recommended Minimum Footprint] If the TO 220 package is used with a heat sink, θ<sub>JA</sub> is the sum of the package thermal resistance junction-to-case (θ<sub>JC</sub>) of 3°C/W and the thermal resistance added by the heat sink and thermal interface the thermal resistance can be reduced by increasing the P.C. board copper area thermally connected to the package. The safe operation area of SOT 223, TO 252, TO 263 or TO 220 package, it can see "Typical Performance Characteristics" (Safe Operating Area).

**Note3:** Low duty pulse techniques are used during test to maintain junction temperature as close to ambient as possible.

**Note4:** The type of output capacitor should be tantalum or aluminum.

**Definitions****Dropout Voltage**

The input/output Voltage differential at which the regulator output no longer maintains regulation against further reductions in input voltage. Measured when the output drops 100mV below its nominal value, dropout voltage is affected by junction temperature, load current and minimum input supply requirements.

**Line Regulation**

The change in output voltage for a change in input voltage. The measurement is made under conditions of low dissipation or by using pulse techniques such that average chip temperature is not significantly affected.

**Load Regulation**

The change in output voltage for a change in load current at constant chip temperature. The measurement is made under conditions of low dissipation or by using pulse techniques such that average chip temperature is not significantly affected.

**Maximum Power Dissipation**

The maximum total device dissipation for which the regulator will operate within specifications.

**Quiescent Bias Current**

Current which is used to operate the regulator chip and is not delivered to the load.



### Typical Performance Characteristics

( $V_{IN}=5V$ ,  $C_{IN}=1\mu F$ ,  $C_{OUT}=10\mu F$ ,  $T_A=25^\circ C$ , unless otherwise noted.)

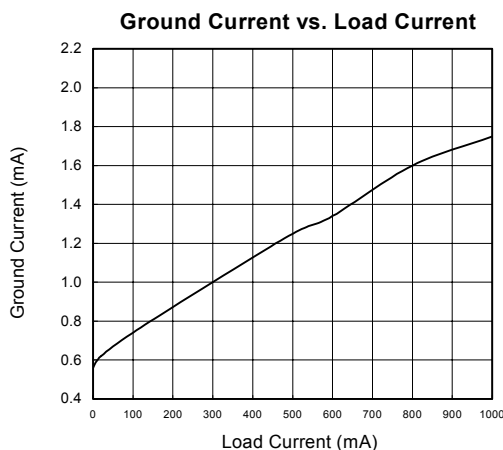
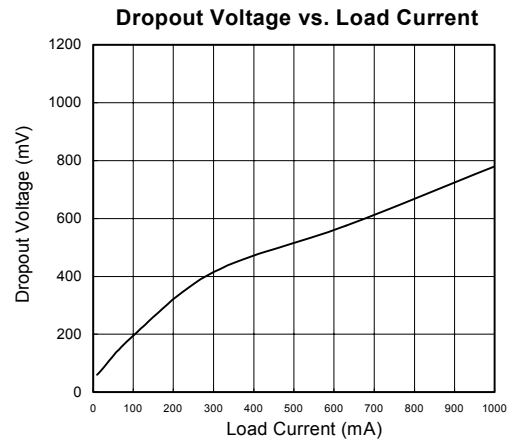
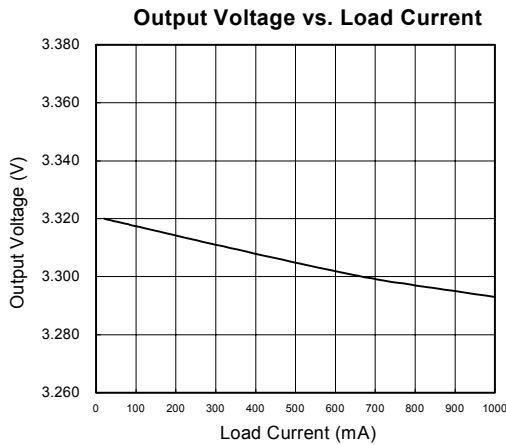
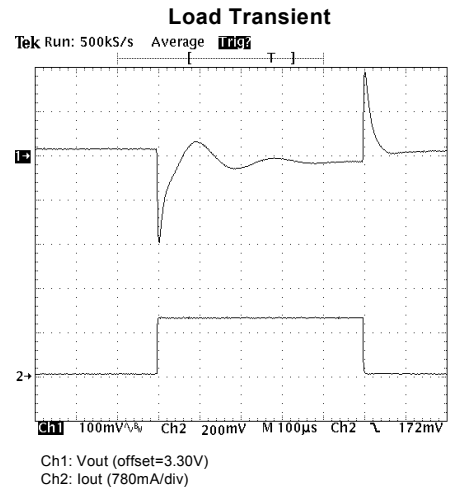
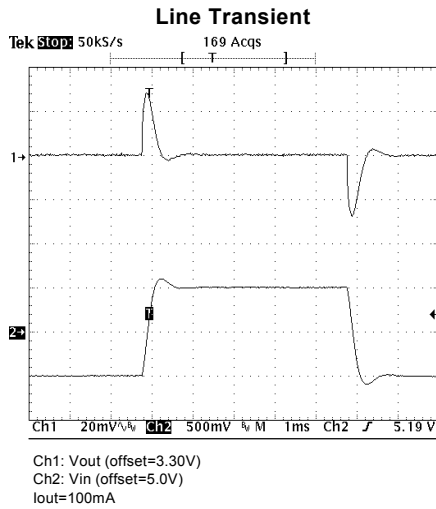



Typical Performance Characteristics (continued)

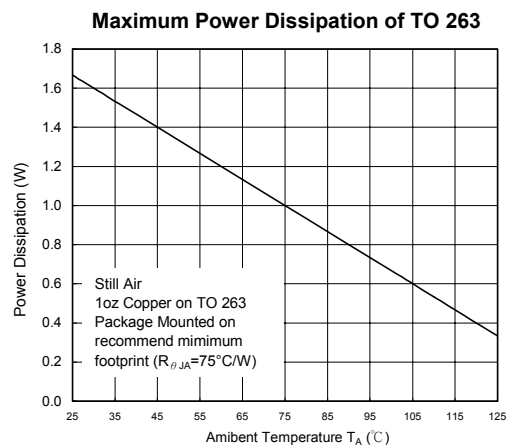
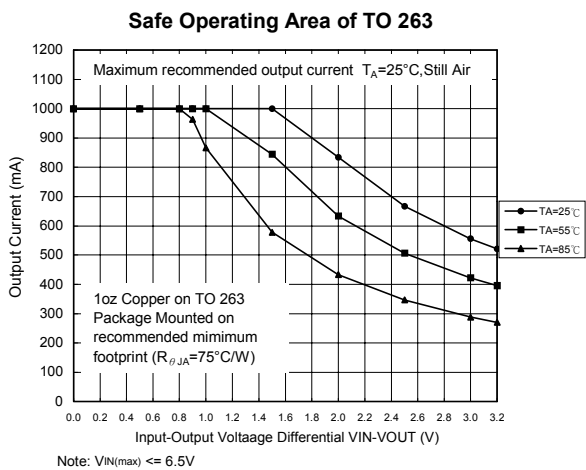
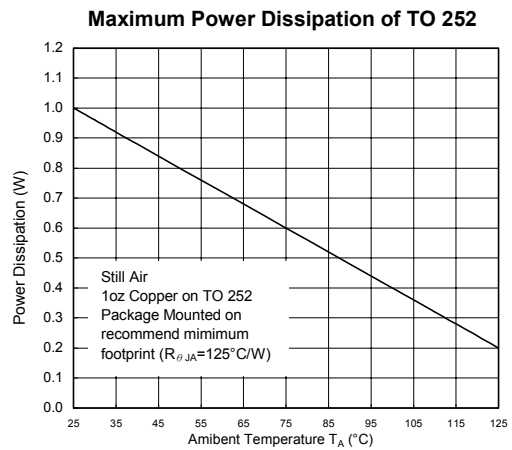
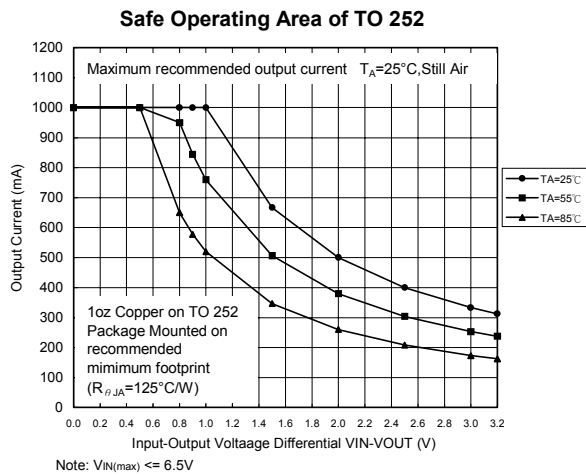
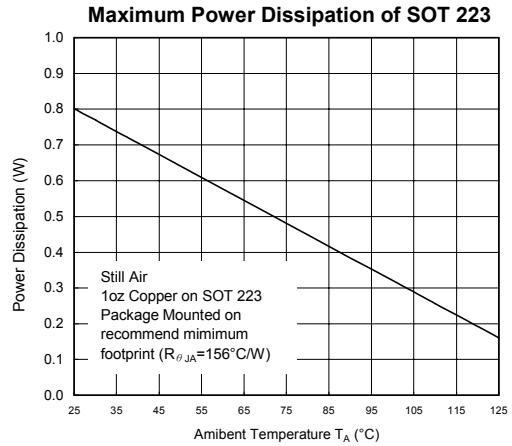
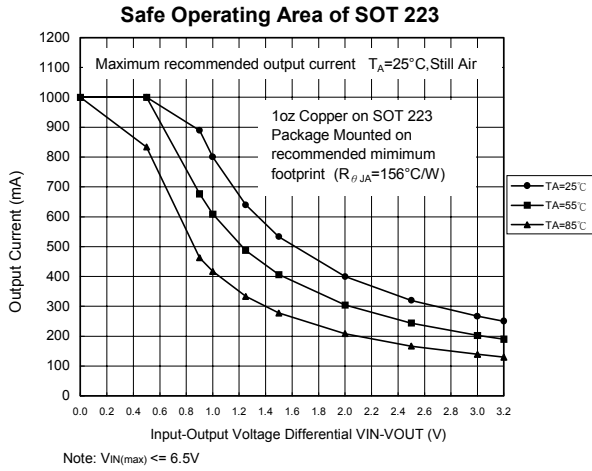

Typical Performance Characteristics (continued)

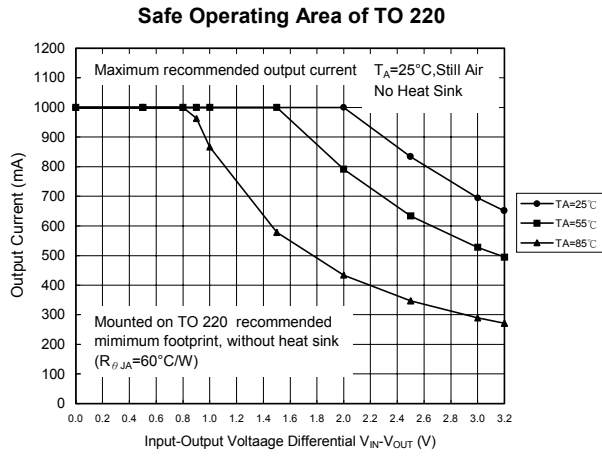

Note:  $V_{IN(max)} \leq 6.5\text{V}$

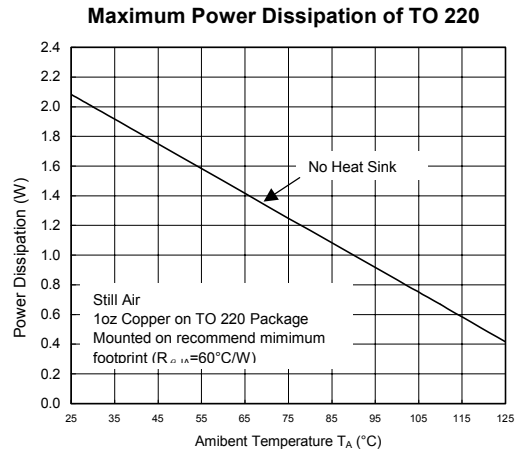

Recommended Minimum Footprint

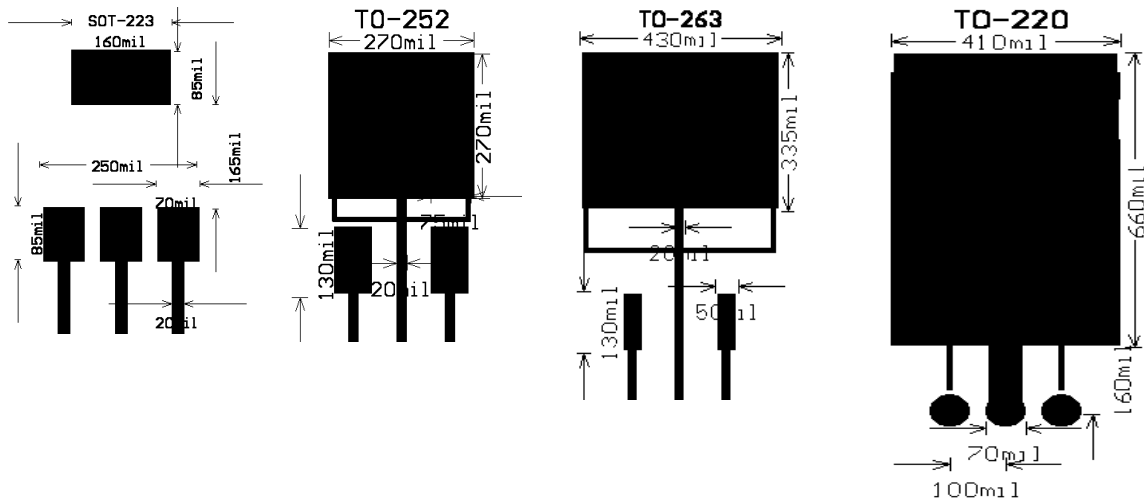

Package Information

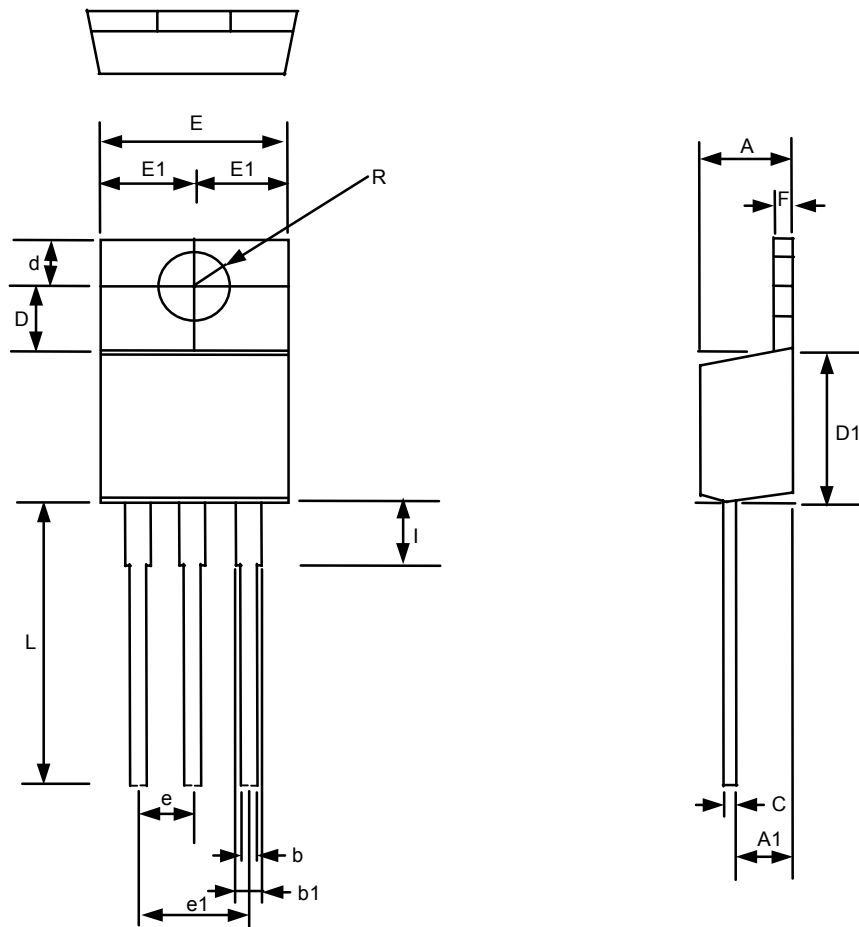

TO-220 (T3) Package

SYMBOLS	MILLIMETERS		INCHES	
	MIN	MAX	MIN	MAX
A	4.318	4.826	0.170	0.190
A1	2.46	2.72	0.097	0.107
b	0.69	0.94	0.027	0.037
b1	1.143	1.397	0.045	0.055
C	0.304	0.460	0.012	0.018
D	3.429	3.683	0.135	0.145
D1	8.53	9.04	0.336	0.356
d	2.62	2.87	0.103	0.113
E	9.906	10.40	0.390	0.410
E1	2.84	5.13	0.112	0.202
e	2.29	2.79	0.090	0.110
e1	4.83	5.33	0.190	0.210
F	1.143	1.397	0.045	0.055
I	3.454	3.962	0.136	0.156
L	13.589	14.351	0.535	0.565

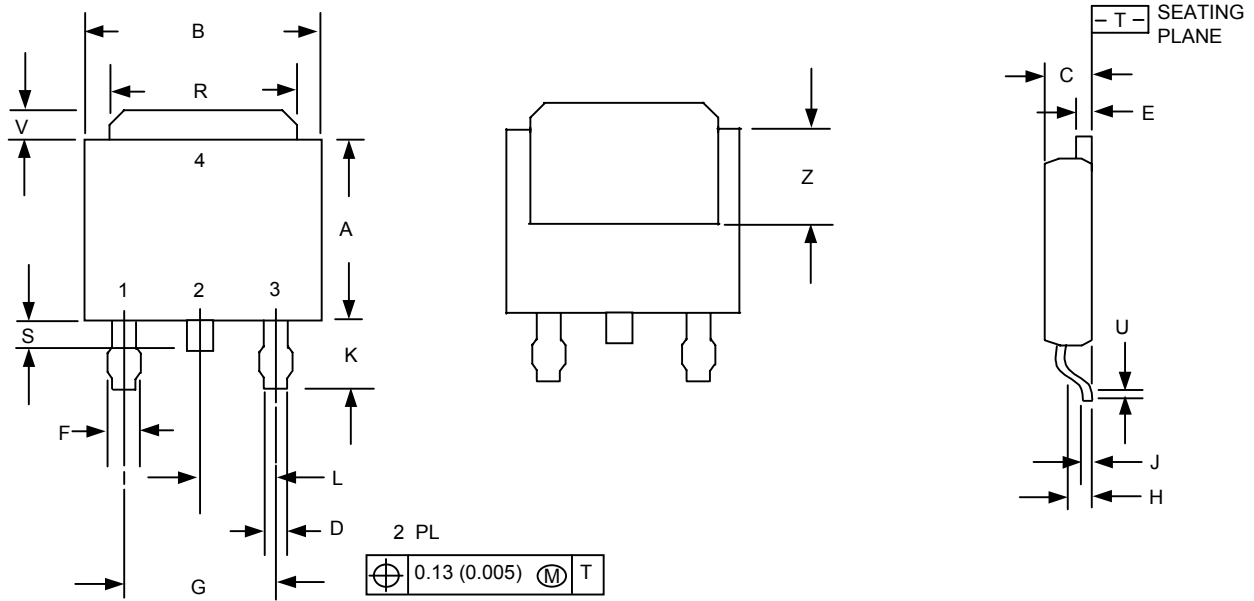

TO-252 (T4) Package

Notes:

1. Dimensioning and tolerancing per ansi y14.5m, 1982.
2. Controlling dimension: inch

SYMBOLS	MILLIMETERS		INCHES	
	MIN	MAX	MIN	MAX
A	5.97	6.35	0.235	0.250
B	6.35	6.73	0.250	0.265
C	2.19	2.38	0.086	0.094
D	0.69	0.88	0.027	0.035
E	0.84	1.01	0.033	0.040
F	0.94	1.19	0.037	0.047
G	4.58BSC		0.180BSC	
H	0.87	1.01	0.034	0.040
J	0.46	0.58	0.018	0.023
K	2.60	2.89	0.102	0.114
L	2.29BSC		0.090BSC	
R	4.45	6.46	0.175	0.215
S	0.51	1.27	0.020	0.050
U	0.51	---	0.020	---
V	0.77	1.27	0.030	0.050
Z	3.51	---	0.138	---

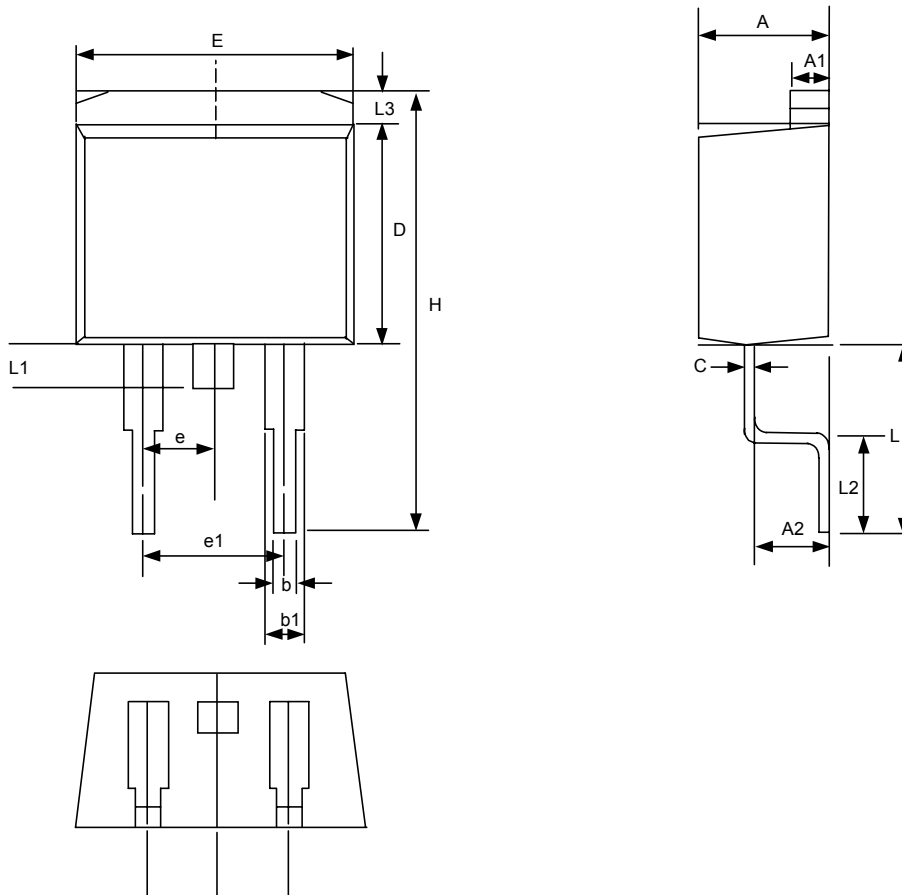

TO-263 (T5) Package

SYMBOLS	MILLIMETERS		INCHES	
	MIN	MAX	MIN	MAX
A	4.30	4.70	0.169	0.185
A1	1.22	1.32	0.048	0.055
A2	2.45	2.69	0.104	0.106
b	0.69	0.94	0.027	0.037
b1	1.22	1.40	0.048	0.055
C	0.36	0.56	0.014	0.022
D	8.64	9.652	0.340	0.380
E	9.70	10.54	0.382	0.415
e	2.29	2.79	0.090	0.110
e1	4.83	5.33	0.190	0.210
H	14.60	15.78	0.575	0.625
L	4.70	5.84	0.185	0.230
L1	1.20	1.778	0.047	0.070
L2	2.24	2.84	0.088	0.111
L3	1.40MAX		0.055MAX	



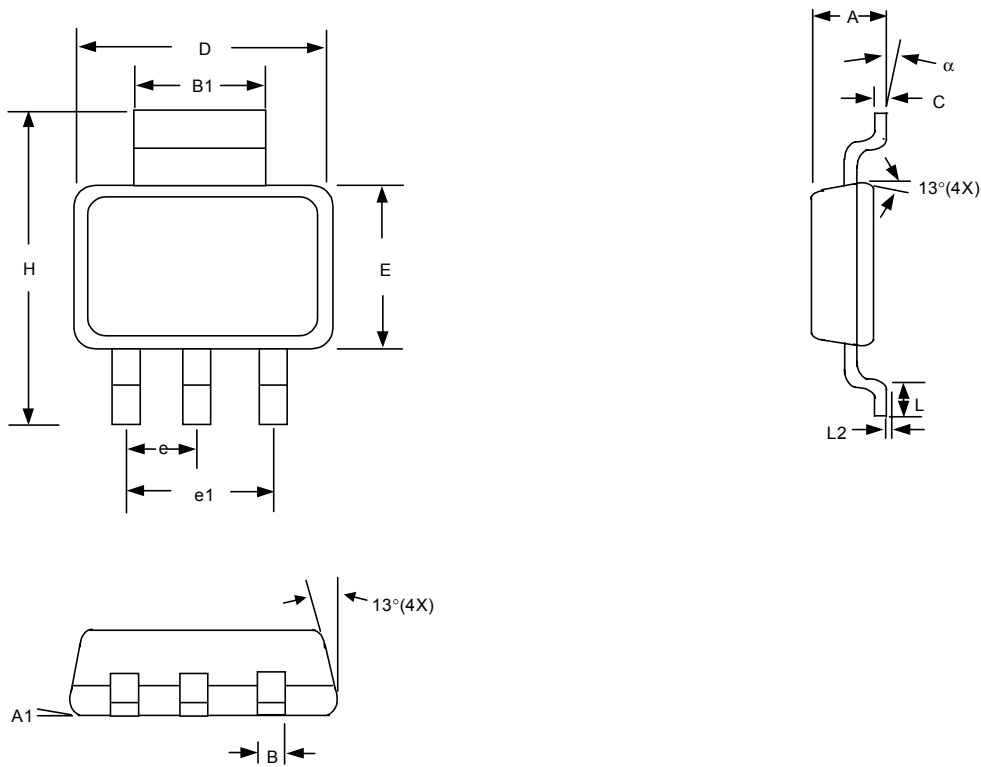

SOT-223 (T6) Package

SYMBOLS	MILLIMETERS		INCHES	
	MIN	MAX	MIN	MAX
A	1.55	1.80	0.061	0.071
A1	0.02	0.12	0.0008	0.0047
B	0.60	0.80	0.024	0.031
B1	2.90	3.10	0.114	0.122
C	0.24	0.32	0.009	0.013
D	6.30	6.70	0.248	0.264
E	3.30	3.70	0.130	0.146
e	2.30 BSC		0.090 BSC	
e1	4.60 BSC		0.181 BSC	
H	6.70	7.30	0.264	0.287
L	0.90 MIN		0.036 MIN	
L2	0.06 BSC		0.0024 BSC	
$\alpha$	0°	10°	0°	10°

Package Orientation

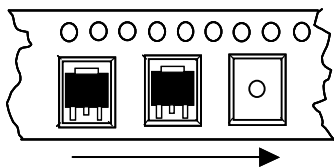

TO252 - 263 Package Orientation

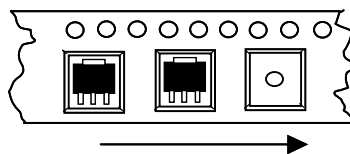

SOT 223 Package Orientation

GMT Inc. does not assume any responsibility for use of any circuitry described, no circuit patent licenses are implied and GMT Inc. reserves the right at any time without notice to change said circuitry and specifications.