

**1:4 LVCMOS to LVPECL Fanout Buffer with Selectable Clock Input**

**Features**

- Select one of two low-voltage complementary metal oxide semiconductor (LVCMOS) inputs to distribute to four low-voltage positive emitter-coupled logic (LVPECL) output pairs
- 30-ps maximum output-to-output skew
- 480-ps maximum propagation delay
- 0.15-ps maximum additive RMS phase jitter at 156.25 MHz (12-kHz to 20-MHz offset)
- Up to 250 MHz operation
- Synchronous clock enable function
- 20-Pin thin shrunk small outline package (TSSOP) package
- 2.5-V or 3.3-V operating voltage<sup>[1]</sup>
- Commercial and industrial operating temperature range

**Functional Description**

The CY2CP1504 is an ultra-low noise, low-skew, low-propagation delay 1:4 LVCMOS to LVPECL fanout buffer targeted to meet the requirements of high-speed clock distribution applications. The CY2CP1504 can select between two separate LVCMOS input clocks using the IN\_SEL pin. The synchronous clock enable function ensures glitch-free output transitions during enable and disable periods. The device has a fully differential internal architecture that is optimized to achieve low additive jitter and low skew at operating frequencies of up to 250 MHz.

**Logic Block Diagram**

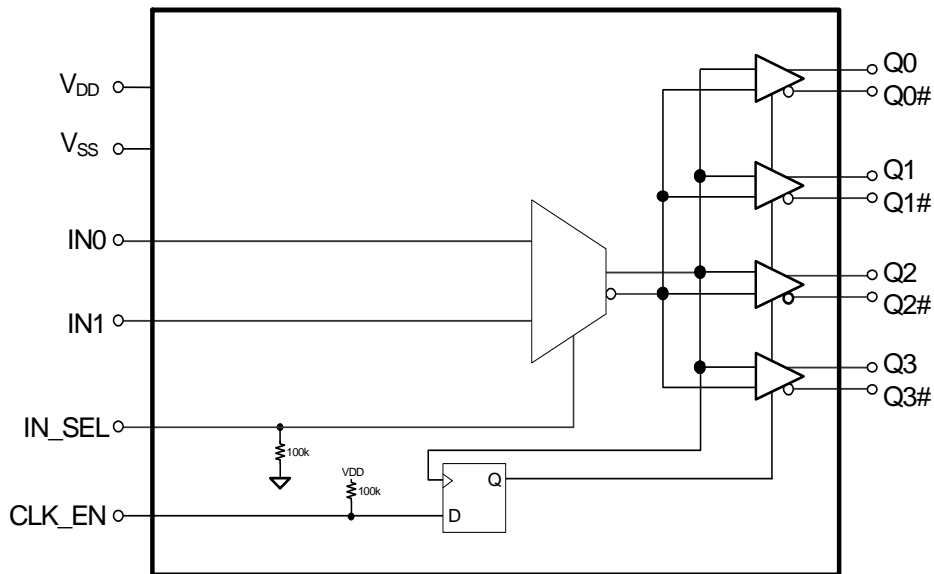

**Note**

1. Input AC-coupling capacitors are required for voltage-translation applications.

## Contents

<b>Pinouts</b> .....	<b>3</b>	<b>Document Conventions</b> .....	<b>11</b>
<b>Absolute Maximum Ratings</b> .....	<b>4</b>	<b>Document History Page</b> .....	<b>12</b>
<b>Operating Conditions</b> .....	<b>4</b>	<b>Sales, Solutions, and Legal Information</b> .....	<b>13</b>
<b>DC Electrical Specifications</b> .....	<b>5</b>	Worldwide Sales and Design Support .....	13
<b>AC Electrical Specifications</b> .....	<b>6</b>	Products .....	13
<b>Ordering Information</b> .....	<b>9</b>	PSoC Solutions .....	13
Ordering Code Definition .....	9		
<b>Package Dimension</b> .....	<b>10</b>		
<b>Acronyms</b> .....	<b>11</b>		

Pinouts

Figure 1. Pin Diagram – 20-Pin TSSOP Package

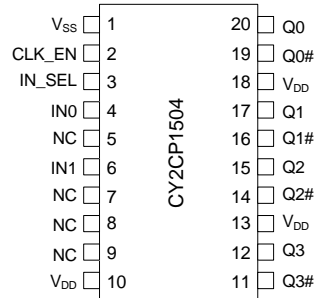

Table 1. Pin Definitions

Pin No.	Pin Name	Pin Type	Description
1	V <sub>SS</sub>	Power	Ground
2	CLK_EN	Input	Synchronous clock enable. LVCMOS/low-voltage transistor-transistor logic (LVTTTL). When CLK_EN = Low, Q(0:3) outputs are held low and Q(0:3)# outputs are held high
3	IN_SEL	Input	Input clock select pin. LVCMOS/LVTTTL; When IN_SEL = Low, input IN0 is active When IN_SEL = High, input IN1 is active
4	IN0	Input	LVCMOS input clock. Active when IN_SEL = Low
5,7,8,9	NC		No connection
6	IN1	Input	LVCMOS input clock. Active when IN_SEL = High
10,13,18	V <sub>DD</sub>	Power	Power supply
11,14,16,19	Q(0:3)#	Output	LVPECL complementary output clocks
12,15,17,20	Q(0:3)	Output	LVPECL output clocks

## Absolute Maximum Ratings

Parameter	Description	Condition	Min	Max	Unit
$V_{DD}$	Supply voltage	Nonfunctional	-0.5	4.6	V
$V_{IN}^{[2]}$	Input voltage, relative to $V_{SS}$	Nonfunctional	-0.5	lesser of 4.0 or $V_{DD} + 0.4$	V
$V_{OUT}^{[2]}$	DC output or I/O voltage, relative to $V_{SS}$	Nonfunctional	-0.5	lesser of 4.0 or $V_{DD} + 0.4$	V
$T_S$	Storage temperature	Nonfunctional	-55	150	°C
$ESD_{HBM}$	Electrostatic discharge (ESD) protection (Human body model)	JEDEC STD 22-A114-B	2000	-	V
$L_U$	Latch up		Meets or exceeds JEDEC Spec JESD78B IC Latchup Test		
UL-94	Flammability rating	At 1/8 in	V-0		
MSL	Moisture sensitivity level		3		

## Operating Conditions

Parameter	Description	Condition	Min	Max	Unit
$V_{DD}$	Supply voltage	2.5-V supply	2.375	2.625	V
		3.3-V supply	3.135	3.465	V
$T_A$	Ambient operating temperature	Commercial	0	70	°C
		Industrial	-40	85	°C
$t_{PU}$	Power ramp time	Power-up time for $V_{DD}$ to reach minimum specified voltage (power ramp must be monotonic)	0.05	500	ms

**Note**

2. The voltage on any I/O pin cannot exceed the power pin during power up. Power supply sequencing is not required.

## DC Electrical Specifications

( $V_{DD} = 3.3\text{ V} \pm 5\%$  or  $2.5\text{ V} \pm 5\%$ ;  $T_A = 0\text{ }^{\circ}\text{C}$  to  $70\text{ }^{\circ}\text{C}$  (Commercial) or  $-40\text{ }^{\circ}\text{C}$  to  $85\text{ }^{\circ}\text{C}$  (Industrial))

Parameter	Description	Condition	Min	Max	Unit
$I_{DD}$	Operating supply current	All LVPECL outputs floating (internal $I_{DD}$ )	–	61	mA
$V_{IH1}$	Input high voltage, All inputs	$V_{DD} = 3.3\text{ V}$	2.0	$V_{DD} + 0.3$	V
$V_{IL1}$	Input low voltage, All inputs	$V_{DD} = 3.3\text{ V}$	–0.3	0.8	V
$V_{IH2}$	Input high voltage, All inputs	$V_{DD} = 2.5\text{ V}$	1.7	$V_{DD} + 0.3$	V
$V_{IL2}$	Input low voltage, All inputs	$V_{DD} = 2.5\text{ V}$	–0.3	0.7	V
$I_{IH}$	Input high current, All inputs	Input = $V_{DD}$ <sup>[3]</sup>	–	150	$\mu\text{A}$
$I_{IL}$	Input low current, All inputs	Input = $V_{SS}$ <sup>[3]</sup>	–150	–	$\mu\text{A}$
$V_{OH}$	LVPECL output high voltage	Terminated with $50\ \Omega$ to $V_{DD} - 2.0$ <sup>[4]</sup>	$V_{DD} - 1.20$	$V_{DD} - 0.70$	V
$V_{OL}$	LVPECL output low voltage	Terminated with $50\ \Omega$ to $V_{DD} - 2.0$ <sup>[4]</sup>	$V_{DD} - 2.0$	$V_{DD} - 1.63$	V
$R_P$	Internal pull-up/pull-down resistance	CLK_EN has pull-up only IN_SEL has pull-down only	60	140	k $\Omega$
$C_{IN}$	Input capacitance	Measured at 10 MHz; per pin	–	3	pF

### Notes

3. Positive current flows into the input pin, negative current flows out of the input pin.
4. Refer to [Figure 2](#) on page 7.

## AC Electrical Specifications

( $V_{DD} = 3.3\text{ V} \pm 5\%$  or  $2.5\text{ V} \pm 5\%$ ;  $T_A = 0\text{ }^\circ\text{C}$  to  $70\text{ }^\circ\text{C}$  (Commercial) or  $-40\text{ }^\circ\text{C}$  to  $85\text{ }^\circ\text{C}$  (Industrial))

Parameter	Description	Condition	Min	Typ	Max	Unit
$F_{IN}$	Input frequency		DC	–	250	MHz
$F_{OUT}$	Output frequency	$F_{OUT} = F_{IN}$	DC	–	250	MHz
$V_{PP}$	LVPECL differential output voltage peak-to-peak, single-ended. Terminated with $50\ \Omega$ to $V_{DD} - 2.0$ <sup>[4]</sup>	$F_{out} = \text{DC to } 150\text{ MHz}$	600	–	–	mV
		$F_{out} = >150\text{ MHz to } 250\text{ MHz}$	400	–	–	mV
$t_{PD}$ <sup>[5]</sup>	Propagation delay input to output pair	Input rise/fall time < 1.5 ns (20% to 80%)	–	–	480	ps
$t_{ODC}$ <sup>[6]</sup>	Output duty cycle	Rail-to-rail input swing, 50% input DTCY measured at $V_{DD}/2$	45	–	55	%
$t_{SK1}$ <sup>[7]</sup>	Output-to-output skew	Any output to any output, with same load conditions at DUT	–	–	30	ps
$t_{SK1D}$ <sup>[7]</sup>	Device-to-device output skew	Any output to any output between two or more devices. Devices must have the same input and have the same output load.	–	–	150	ps
$PN_{ADD}$	Additive RMS phase noise 156.25-MHz Input Rise/fall time < 150 ps (20% to 80%) $V_{ID} > 400\text{ mV}$	Offset = 1 kHz	–	–	–120	dBc/Hz
		Offset = 10 kHz	–	–	–130	dBc/Hz
		Offset = 100 kHz	–	–	–135	dBc/Hz
		Offset = 1 MHz	–	–	–150	dBc/Hz
		Offset = 10 MHz	–	–	–150	dBc/Hz
		Offset = 20 MHz	–	–	–150	dBc/Hz
$t_{JIT}$ <sup>[8]</sup>	Additive RMS phase jitter (Random)	156.25 MHz sinewave, 12 kHz to 20 MHz offset; input swing = 2.2V, $V_{bias} = V_{DD}/2$	–	–	0.15	ps
$t_R, t_F$ <sup>[9]</sup>	Output rise/fall time	50% duty cycle at input, 20% to 80% of full swing ( $V_{OL}$ to $V_{OH}$ ) Input rise/fall time < 1.5 ns (20% to 80%)	–	–	300	ps
$t_{SOD}$	Time from clock edge to outputs disabled	Synchronous clock enable (CLK_EN) switched Low	–	–	700	ps
$t_{SOE}$	Time from clock edge to outputs enabled	Synchronous clock enable (CLK_EN) switched high	–	–	700	ps

### Notes

5. Refer to [Figure 3](#) on page 7.
6. Refer to [Figure 4](#) on page 7.
7. Refer to [Figure 5](#) on page 7.
8. Refer to [Figure 6](#) on page 8.
9. Refer to [Figure 7](#) on page 8.

Figure 2. Output Differential Voltage

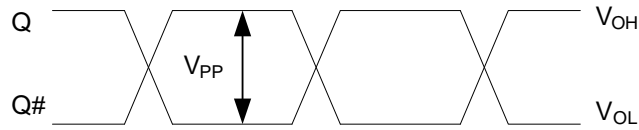

Figure 3. Input to Any Output Pair Propagation Delay

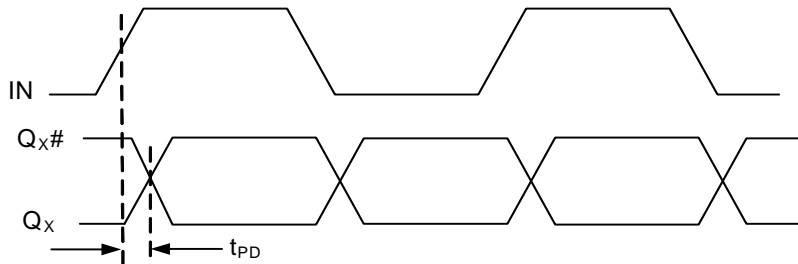

Figure 4. Output Duty Cycle

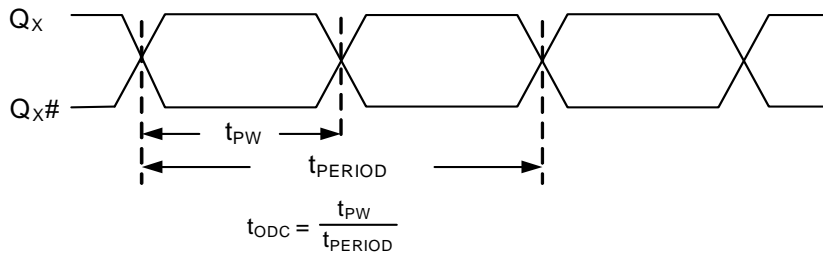

Figure 5. Output-to-Output and Device-to-Device Skew

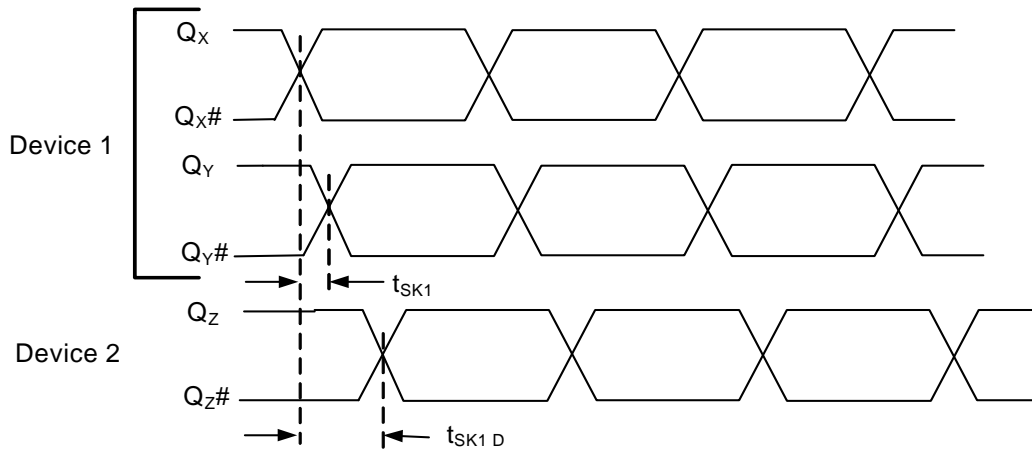

Figure 6. RMS Phase Jitter

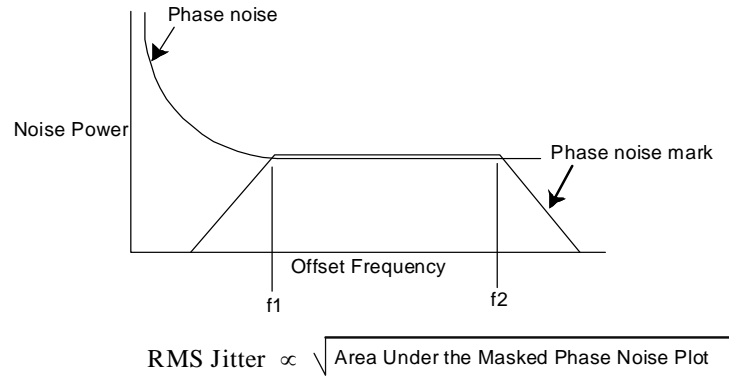

Figure 7. Output Rise/Fall Time

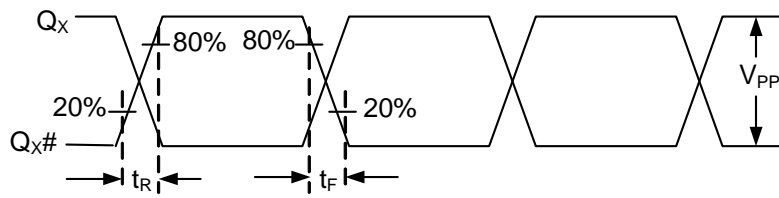
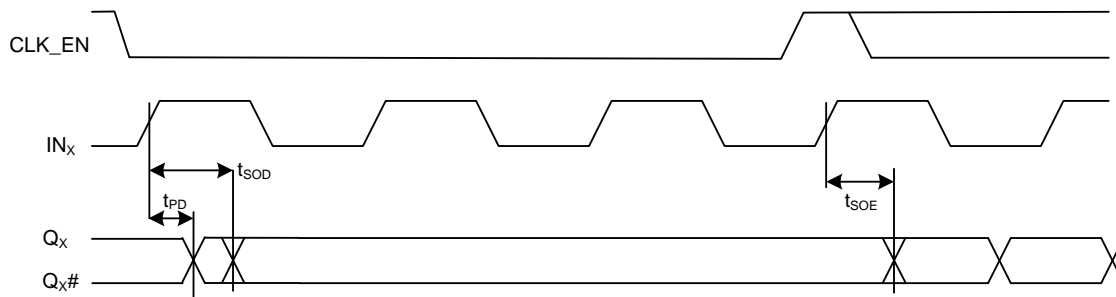

Figure 8. Synchronous Clock Enable Timing





### Ordering Information

Part Number	Type	Production Flow
<b>Pb-free</b>		
CY2CP1504ZXC	20-Pin TSSOP	Commercial, 0 °C to 70 °C
CY2CP1504ZXCT	20-Pin TSSOP tape and reel	Commercial, 0 °C to 70 °C
CY2CP1504ZXI	20-Pin TSSOP	Industrial, -40 °C to 85 °C
CY2CP1504ZXIT	20-Pin TSSOP tape and reel	Industrial, -40 °C to 85 °C

### Ordering Code Definition

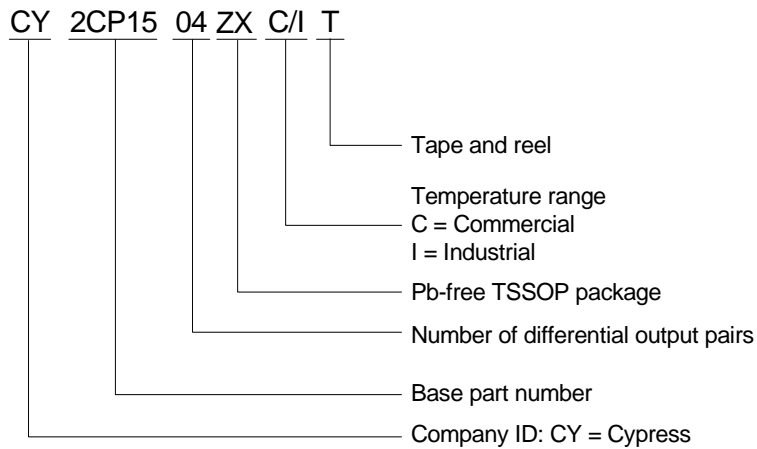

Package Dimension

Figure 9. 20-Pin Thin Shrunk Small Outline Package (4.40-mm Body) ZZ20

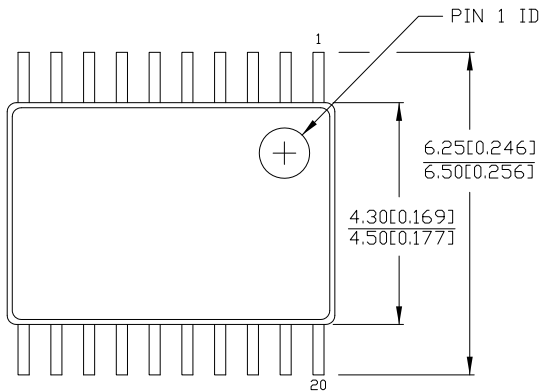

DIMENSIONS IN MM[INCHES] MIN. MAX.

REFERENCE JEDEC MO-153

PART #	
Z20.173	STANDARD PKG.
ZZ20.173	LEAD FREE PKG.

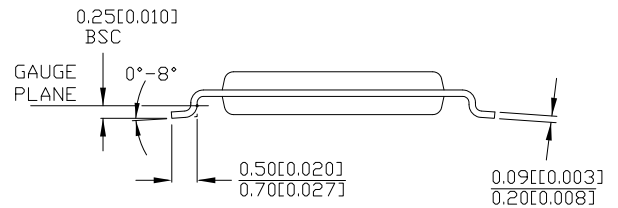
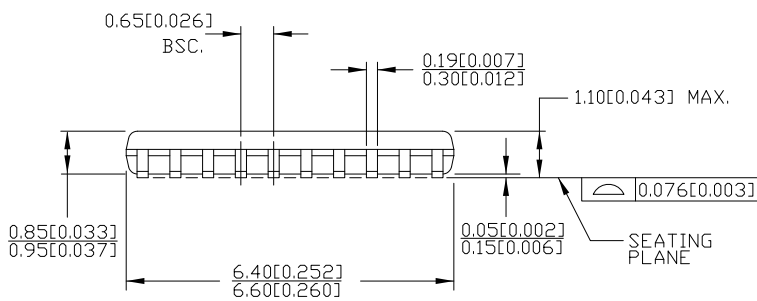

51-85118 \*C

## Acronyms

Table 2. Acronyms Used in this Document

Acronym	Description
ESD	electrostatic discharge
HBM	human body model
JEDEC	Joint electron devices engineering council
LVDS	low-voltage differential signal
LVC MOS	low-voltage complementary metal oxide semiconductor
LVPECL	low-voltage positive emitter-coupled logic
LVTTTL	low-voltage transistor-transistor logic
OE	Output enable
RMS	root mean square
TSSOP	thin shrunk small outline package

## Document Conventions

Table 3. Units of Measure

Symbol	Unit of Measure
°C	degree Celsius
dBc	decibels relative to the carrier
GHz	giga hertz
Hz	hertz
kΩ	kilo ohm
μA	microamperes
μF	micro Farad
μs	microsecond
mA	milliamperes
ms	millisecond
mV	millivolt
MHz	megahertz
ns	nanosecond
Ω	ohm
pF	pico Farad
ps	pico second
V	volts
W	watts

Document History Page

Document Title: CY2CP1504 1:4 LVCMOS to LVPECL Fanout Buffer with Selectable Clock Input				
Document Number: 001-56313				
Revision	ECN	Orig. of Change	Submission Date	Description of Change
**	2782891	CXQ	10/09/09	New Datasheet
*A	2838916	CXQ	05/01/2010	<p>Changed status from "ADVANCE" to "PRELIMINARY".</p> <p>Changed from 0.34 ps to 0.25 ps maximum additive jitter in "Features" on page 1 and in <math>t_{JIT}</math> in the AC Electrical Specs table on page 5.</p> <p>Added <math>t_{PU}</math> spec to the Operating Conditions table on page 3.</p> <p>Changed max <math>I_{DD}</math> spec in the DC Electrical Specs table on page 4 from 60 mA to 61 mA.</p> <p>Changed <math>V_{OH}</math> in the DC Electrical Specs table on page 4: minimum from <math>V_{DD} - 1.15V</math> to <math>V_{DD} - 1.20V</math>; maximum from <math>V_{DD} - 0.75V</math> to <math>V_{DD} - 0.70V</math>.</p> <p>Removed <math>V_{OD}</math> spec from the DC Electrical Specs table on page 4.</p> <p>Added <math>R_P</math> spec in the DC Electrical Specs table on page 4. Min = 60 k<math>\Omega</math>, Max = 140 k<math>\Omega</math>.</p> <p>Added a measurement definition for <math>C_{IN}</math> in the DC Electrical Specs table on page 4.</p> <p>Added <math>V_{PP}</math> spec to the AC Electrical Specs table on page 5. <math>V_{PP}</math> min = 600 mV for DC - 150 MHz and min = 400 mV for 150 MHz to 250 MHz.</p> <p>Changed letter case and some names of all the timing parameters in the AC Electrical Specs table on page 5 to be consistent with EROS.</p> <p>Lowered all additive phase noise mask specs by 3 dB in the AC Electrical Specs table on page 5.</p> <p>Added condition to <math>t_R</math> and <math>t_F</math> specs in the AC Electrical specs table on page 5 that input rise/fall time must be less than 1.5 ns (20% to 80%).</p> <p>Changed letter case and some names of all the timing parameters in Figures 2, 3, 4, 5 and 7, to be consistent with EROS.</p>
*B	3011766	CXQ	08/20/2010	<p>Changed from 0.25 ps to 0.15 ps maximum additive jitter in "Features" on page 1 and in <math>t_{JIT}</math> in the AC Electrical Specs table on page 6.</p> <p>Added note 2 to describe <math>I_{IH}</math> and <math>I_{IL}</math> specs.</p> <p>Removed reference to data distribution from "Functional Description".</p> <p>Updated phase noise specs for 1 k/10 k/100 k/1 M/10 M/20 MHz offset to -120/-130/-135/-150/-150/-150dBc/Hz, respectively, in the AC Electrical Specs table.</p> <p>Updated package diagram.</p> <p>Added Acronyms and Ordering Code Definition.</p>
*C	3017258	CXQ	08/27/2010	Corrected Output Rise/Fall time diagram.
*D	3100234	CXQ	11/18/2010	<p>Changed <math>V_{IN}</math> and <math>V_{OUT}</math> specs from 4.0V to "lesser of 4.0 or <math>V_{DD} + 0.4</math>"</p> <p>Removed 200mA min LU spec, replaced with "Meets or exceeds JEDEC Spec JESD78B IC Latchup Test"</p> <p>Changed <math>C_{IN}</math> condition to "Measured at 10 MHz".</p> <p>Removed <math>t_R</math> and <math>t_F</math> input specs from AC specs table.</p> <p>Changed <math>t_{ODC}</math> from 48/52% to 45/55%, changed condition to "Rail-to-rail input swing, 50% input duty cycle measured at <math>V_{DD}/2</math>".</p> <p>Changed phase jitter condition to "156.25 MHz sinewave, 12 kHz to 20 MHz offset; input swing = 2.2V, <math>V_{bias} = V_{DD}/2</math>"</p> <p>Removed <math>t_S</math> and <math>t_H</math> specs from AC specs table.</p>
*E	3137726	CXQ	01/13/2011	<p>Removed "Preliminary" status heading.</p> <p>Removed resistors from IN0/IN1 in <a href="#">Logic Block Diagram</a>.</p> <p>Added <a href="#">Figure 8</a> to describe <math>T_{SOE}</math> and <math>T_{SOD}</math>.</p>
*F	3182321	CXQ	02/25/11	Post to external web.

## Sales, Solutions, and Legal Information

### Worldwide Sales and Design Support

Cypress maintains a worldwide network of offices, solution centers, manufacturer's representatives, and distributors. To find the office closest to you, visit us at [Cypress Locations](#).

#### Products

<a href="#">Automotive</a>	<a href="#">cypress.com/go/automotive</a>
<a href="#">Clocks &amp; Buffers</a>	<a href="#">cypress.com/go/clocks</a>
<a href="#">Interface</a>	<a href="#">cypress.com/go/interface</a>
<a href="#">Lighting &amp; Power Control</a>	<a href="#">cypress.com/go/powerpsoc</a> <a href="#">cypress.com/go/plc</a>
<a href="#">Memory</a>	<a href="#">cypress.com/go/memory</a>
<a href="#">Optical &amp; Image Sensing</a>	<a href="#">cypress.com/go/image</a>
<a href="#">PSoC</a>	<a href="#">cypress.com/go/psoc</a>
<a href="#">Touch Sensing</a>	<a href="#">cypress.com/go/touch</a>
<a href="#">USB Controllers</a>	<a href="#">cypress.com/go/USB</a>
<a href="#">Wireless/RF</a>	<a href="#">cypress.com/go/wireless</a>

#### PSoC Solutions

[psoc.cypress.com/solutions](#)  
[PSoC 1](#) | [PSoC 3](#) | [PSoC 5](#)

---

© Cypress Semiconductor Corporation, 2009-2011. The information contained herein is subject to change without notice. Cypress Semiconductor Corporation assumes no responsibility for the use of any circuitry other than circuitry embodied in a Cypress product. Nor does it convey or imply any license under patent or other rights. Cypress products are not warranted nor intended to be used for medical, life support, life saving, critical control or safety applications, unless pursuant to an express written agreement with Cypress. Furthermore, Cypress does not authorize its products for use as critical components in life-support systems where a malfunction or failure may reasonably be expected to result in significant injury to the user. The inclusion of Cypress products in life-support systems application implies that the manufacturer assumes all risk of such use and in doing so indemnifies Cypress against all charges.

Any Source Code (software and/or firmware) is owned by Cypress Semiconductor Corporation (Cypress) and is protected by and subject to worldwide patent protection (United States and foreign), United States copyright laws and international treaty provisions. Cypress hereby grants to licensee a personal, non-exclusive, non-transferable license to copy, use, modify, create derivative works of, and compile the Cypress Source Code and derivative works for the sole purpose of creating custom software and or firmware in support of licensee product to be used only in conjunction with a Cypress integrated circuit as specified in the applicable agreement. Any reproduction, modification, translation, compilation, or representation of this Source Code except as specified above is prohibited without the express written permission of Cypress.

Disclaimer: CYPRESS MAKES NO WARRANTY OF ANY KIND, EXPRESS OR IMPLIED, WITH REGARD TO THIS MATERIAL, INCLUDING, BUT NOT LIMITED TO, THE IMPLIED WARRANTIES OF MERCHANTABILITY AND FITNESS FOR A PARTICULAR PURPOSE. Cypress reserves the right to make changes without further notice to the materials described herein. Cypress does not assume any liability arising out of the application or use of any product or circuit described herein. Cypress does not authorize its products for use as critical components in life-support systems where a malfunction or failure may reasonably be expected to result in significant injury to the user. The inclusion of Cypress' product in a life-support systems application implies that the manufacturer assumes all risk of such use and in doing so indemnifies Cypress against all charges.

Use may be limited by and subject to the applicable Cypress software license agreement.