

## Standard recovery Diode

### Features

1. Medium voltage, high current rectifier diodes with slim package for lowest thermal resistance
2. Low power dissipation
3. Especially suited for water cooling
4. Forward selections for paralleling available

### Typical Applications

1. Welding
2. Electroplating

Ordering code

<b>D</b>	<b>12000</b>	<b>W</b>	<b>xx</b>
(1)	(2)	(3)	(4)

- (1) stands for disc types diodes  
 (2) Maximum average forward current , A  
 (3) package style  
 (4) Voltage code , V ( code x 100 =  $V_{RRM}$  )

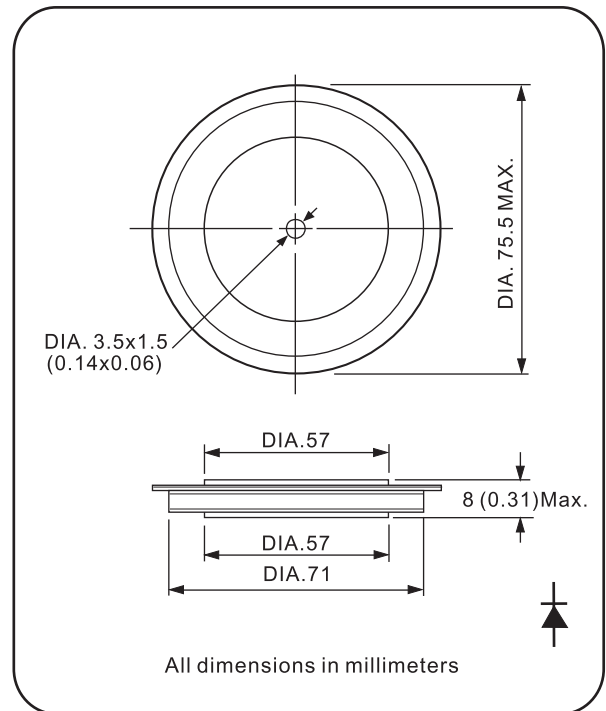

### Electrical Characteristics

Symbol	Parameter	Condition	Value	Unit
$I_F(AV)$	Average forward current	180° half sine wave, 50 Hz Double side cooled, $T_c=85^\circ C$	12000	A
$V_{RRM}$	Repetitive peak reverse voltage	$t_p=10\text{ ms } V_{RSM}=V_{RRM} + 100V$	200 to 600	V
$I_{RRM}$	Repetitive peak reverse current	$V_R=V_{RRM}$	80	mA
$I_{FSM}$	Surge forward current	10ms half sine wave	88000	A
$I_t^2$	$I_t^2$ for fusing coordination	$V_R=0.6 V_{RRM}$	36000	$KA^2S$
$V_{FO}$	Threshold voltage	Approximation for $I_F=8000\text{ to }18000A$	0.74	V
$r_f$	Slope resistance		0.026	mΩ
$V_{FM}$	Peak on-state voltage	Forward current=12000A, $T_J=25^\circ C$	0.9	V
$R_{th(j-c)}$	Thermal resistance( junction to case )	At 180 sine, Double side cooled Clamping force 24.0 KN	0.006	$^\circ C/W$
$R_{th(c-hs)}$	Thermal resistance( case to heatsink )		0.012	$^\circ C/W$
$T_{stg}$	Storage temperature range		-40 to 170	$^\circ C$
$T_j$	Max.junction operating temperature range		-40 to 150	$^\circ C$
$W_t$	Approximate weight		230	g
$F_m$	Mounting force		30 to 35	KN

Fig.1 Maximum forward voltage drop characteristics

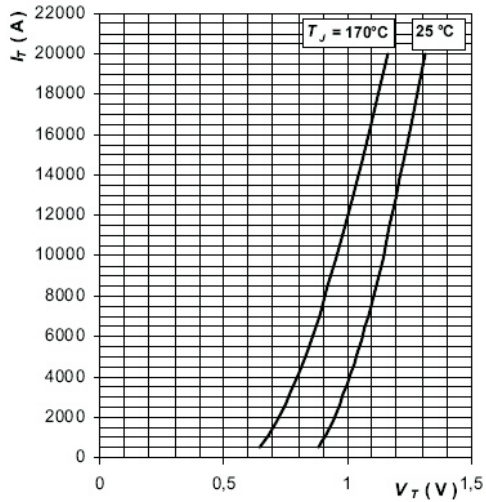

Fig.2 Surge forward current vs pulse length

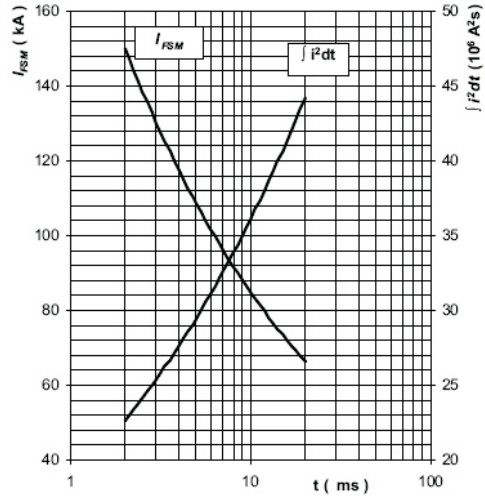

Fig.3 Forward power loss vs. Average forward current sine waveform

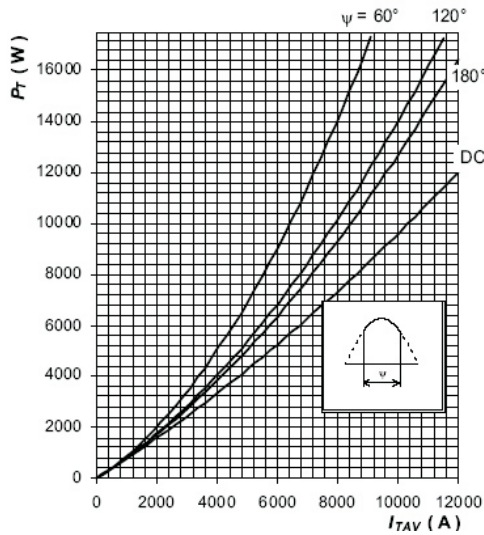

Fig.4 Forward power loss vs. Average forward current, square waveform

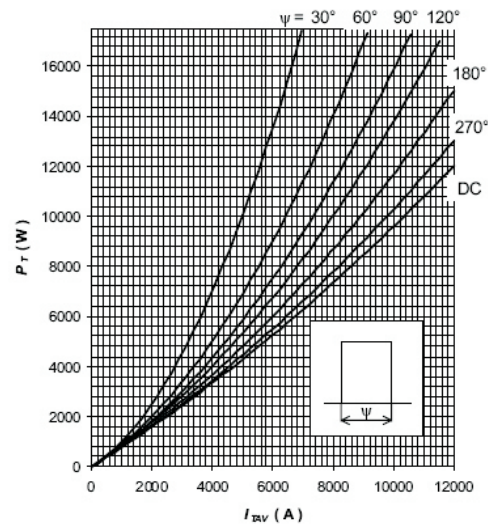

Fig.5 Max. case temperature vs. Ever forward current, sine waveform

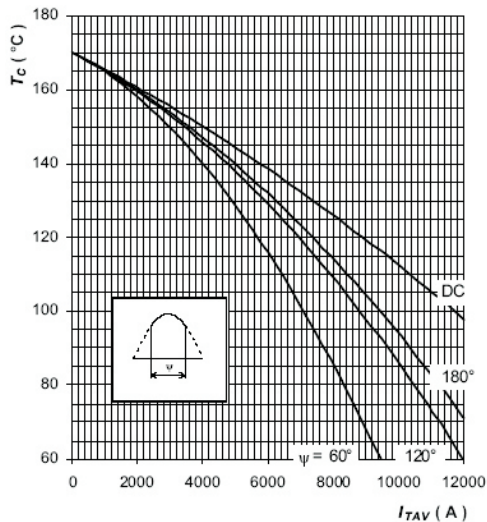

Fig.6 Max. Case temperature vs. Average forward current, square waveform

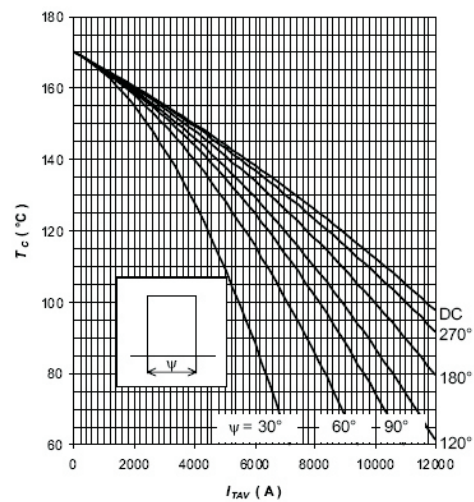

Fig.7 DC-output current with single-phase centre tap

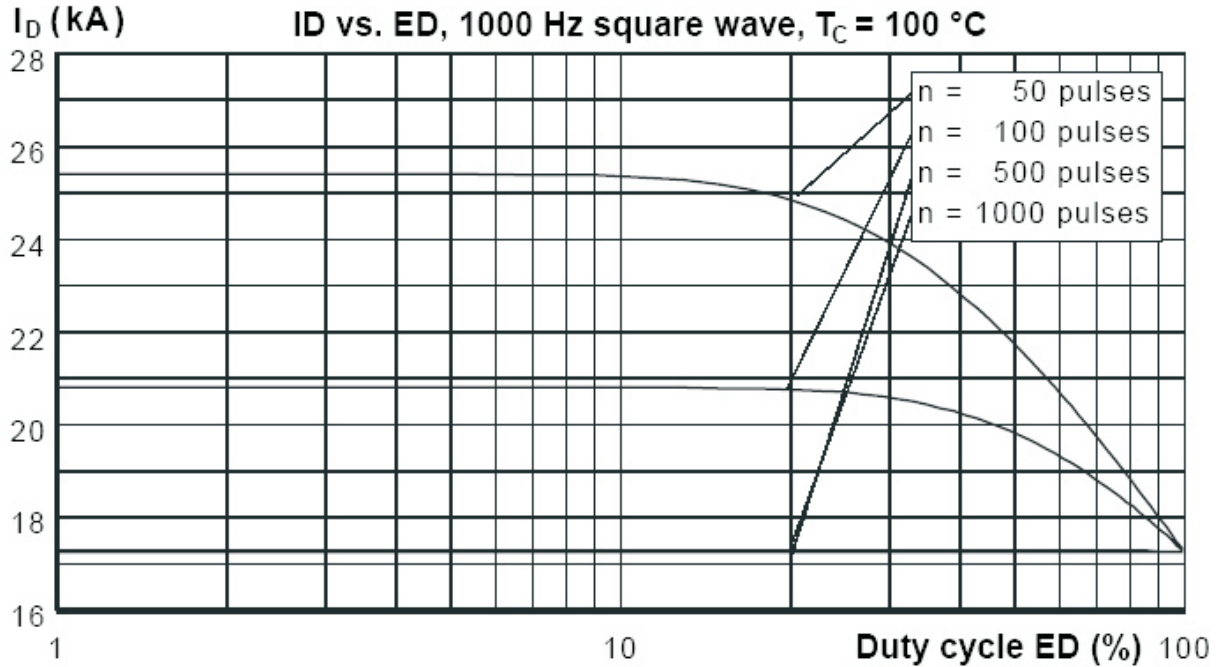

Fig.8 DC-output current with single-phase centre tap

