

FUSE HOLDER FOR MAXI® STYLE BLADE FUSE

RoHS



Description

This fuse holder provides an efficient, simple installation method for MAXI® / FK3-Style Fuse applications.

Ordering Information

Part Number	Package Size
01520001TXN	10
01520001U	500

Dimensions

Dimensions in mm

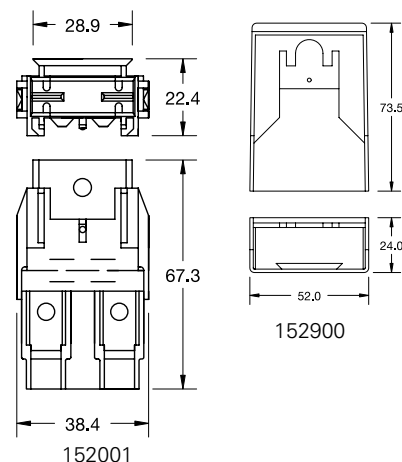

Ratings

Part Number	Description	Fuse Rating
01520001TXN940	Assortment: Fuse Holder with screws and terminals - 10 pcs.	60 A
01520001TXN941	Assortment: Fuse Holder, Cover with screws and terminals - 10 pcs.	60 A

MAXI® COMPONENTS

Ratings

Part Number	Description
01520001_	Fuse Holder
01520900_	Cover
09130653_	Terminals for wire Ø 2.5 - 6 mm ²
09130654_	Terminals for wire Ø 5 - 10 mm ²
09130550_	Screws Ø 5.3 mm, M 5x8

Ordering Information

Part Number	Package Size
01520001TXN	10
01520900TXN	10
01520900H	100
01520900U	500
09130550LXN	50
09130550Z	1
09130653LXN	50
09130653Z	1500
09130654LXN	50
09130654Z	1000