



SGM4890 1.1W Audio Power Amplifier

GENERAL DESCRIPTION

The SGM4890 is a 1.1W, fully integrated, audio power amplifier. It is designed to maximize audio performance in portable applications such as mobile phone. The portable application requires audio power amplifier has minimum of external components and can operate from a single 2.5V to 5.5V power supply. SGM4890 is capable of delivering 1.1W of continuous output power with typically 1% distortion (THD+N) when it drives an 8Ω speaker from a 5.0V power supply.

The SGM4890 features a low power consumption shutdown mode, which is achieved by driving the shutdown pin with a logic low. Additionally, the SGM4890 features an internal thermal shutdown protection mechanism.

The SGM4890 does not require output coupling capacitors or bootstrap capacitors, and therefore is ideally suited for mobile phone and other low voltage applications where minimal power consumption is a primary requirement.

For maximum flexibility, the SGM4890 provides an externally controlled gain (with resistors), as well as an externally controlled turn-on time (with the bypass capacitor). When using a 1μF bypass capacitor, it offers 110ms wake-up time when V_+ is equal to 5.0V.

The SGM4890 is available in Green MSOP-8 package. It operates over an ambient temperature range of -40°C to +85°C.

FEATURES

- **Ideal for Notebook Computers, PDAs, and Other Small Portable Audio Devices**
- **1.1W into 8Ω BTL Load from 5V Supply at THD+N = 1% (TYP)**
- **Excellent PSRR: Direct Connection to Battery**
- **Fast Turn-On Time**
- **Unity Gain Stable**
- **2.5V to 5.5V Operation**
- **Shutdown Current: 0.01μA (TYP)**
- **Shutdown Pin is Compatible with 1.8V Logic**
- **-40°C to +85°C Operating Temperature Range**
- **Small Packaging**

APPLICATIONS

Portable Systems
MP3 Players
Mobile Phone
PDAs
GPS



PACKAGE/ORDERING INFORMATION

MODEL	ORDER NUMBER	PACKAGE DESCRIPTION	PACKAGE OPTION	MARKING INFORMATION
SGM4890	SGM4890YMS/TR	MSOP-8	Tape and Reel, 3000	SGM4890YMS

ABSOLUTE MAXIMUM RATINGS

Supply Voltage.....	6V
Input Voltage.....	-0.3V to (V+) + 0.3V
Storage Temperature Range.....	-65°C to +150°C
Junction Temperature.....	150°C
Operating Temperature Range.....	-40°C to +85°C
Lead Temperature Range (Soldering 10sec)	260°C
ESD Susceptibility	
HBM.....	2000V
MM.....	200V

NOTE:

Stresses beyond those listed under “Absolute Maximum Ratings” may cause permanent damage to the device. These are stress ratings only, and functional operation of the device at these or any other conditions beyond those indicated in the operational sections of the specifications is not implied. Exposure to absolute maximum rating conditions for extended periods may affect device reliability.

CAUTION

This integrated circuit can be damaged by ESD if you don't pay attention to ESD protection. SGMICRO recommends that all integrated circuits be handled with appropriate precautions. Failure to observe proper handling and installation procedures can cause damage. ESD damage can range from subtle performance degradation to complete device failure. Precision integrated circuits may be more susceptible to damage because very small parametric changes could cause the device not to meet its published specifications.

SGMICRO reserves the right to make any change in circuit design, specification or other related things if necessary without notice at any time. Please contact SGMICRO sales office to get the latest datasheet.

PIN CONFIGURATION (TOP VIEW)

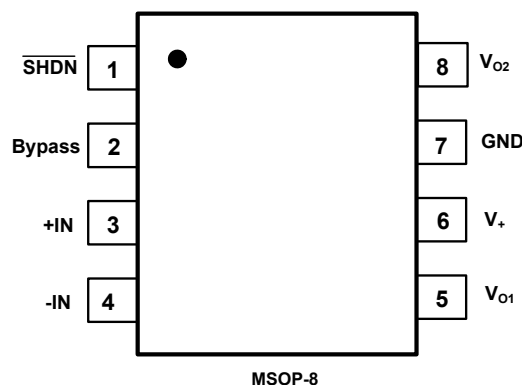

ELECTRICAL CHARACTERISTICS(T_A = +25°C, unless otherwise specified.)

PARAMETER	SYMBOL	CONDITIONS		MIN	TYP	MAX	UNITS
Quiescent Power Supply Current	I _Q	V _{IN} = 0V, I _O = 0A	V ₊ = +5.0V, No Load		4	8	mA
			V ₊ = +5.0V, 8Ω Load		6	10	
			V ₊ = +3.6V, No Load		3.7		
			V ₊ = +3.6V, 8Ω Load		5.7		
			V ₊ = +3.0V, No Load		3.5	7	
			V ₊ = +3.0V, 8Ω Load		5.5	9	
			V ₊ = +2.6V, No Load		3.3		
			V ₊ = +2.6V, 8Ω Load		5.3		
Shutdown Current	I _{SD}	V _{SHUTDOWN} = 0V			0.01	4.0	μA
Shutdown Voltage Input High	V _{SDIH}			1.2			V
Shutdown Voltage Input Low	V _{SDIL}					0.4	V
Output Offset Voltage	V _{OS}				1	50	mV
Output Power (8Ω)	P _O	f = 1kHz, THD+N = 1%	V ₊ = +5.0V		1.10		W
			V ₊ = +3.6V		0.58		
			V ₊ = +3.0V		0.40		
			V ₊ = +2.6V		0.30		
Total Harmonic Distortion + Noise	THD+N	P _O = 0.4Wrms, f = 1kHz			0.01		%
Power Supply Rejection Ratio	PSRR	f = 217Hz	V ₊ = +5.0V		-66		dB
			V ₊ = +3.6V		-63		
			V ₊ = +3.0V		-63		
			V ₊ = +2.6V		-62		
		f = 1kHz	V ₊ = +5.0V		-72		
			V ₊ = +3.6V		-68		
			V ₊ = +3.0V		-66		
			V ₊ = +2.6V		-64		
Wake-Up Time	T _{WU}	C _{BYPASS} = 1μF	V ₊ = +5.0V		110		ms
			V ₊ = +3.6V		110		
			V ₊ = +3.0V		100		
			V ₊ = +2.6V		100		
Shutdown Time	T _{SdT}	8Ω Load	V ₊ = +5.0V		10		μs
			V ₊ = +3.6V		16		
			V ₊ = +3.0V		17.8		
			V ₊ = +2.6V		17.8		

TYPICAL PERFORMANCE CHARACTERISTICS

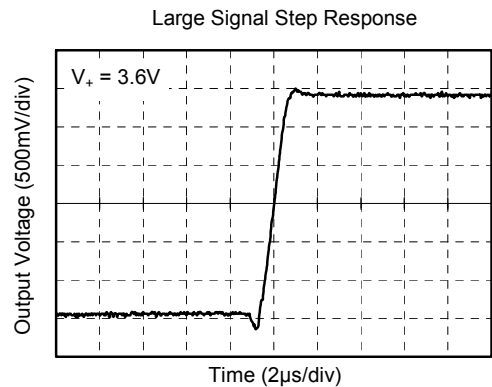
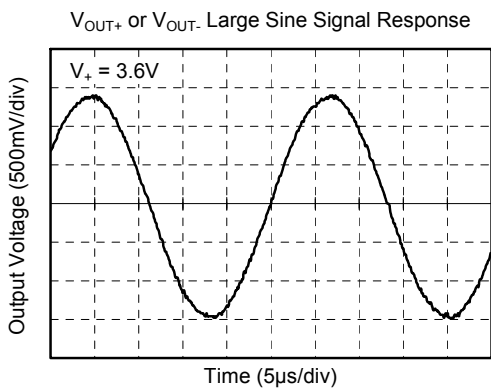
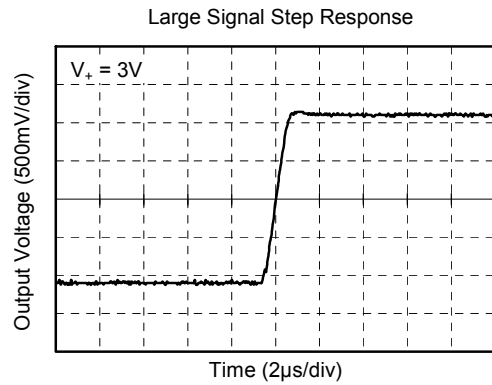
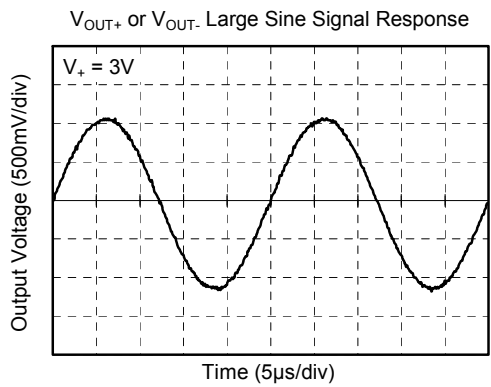
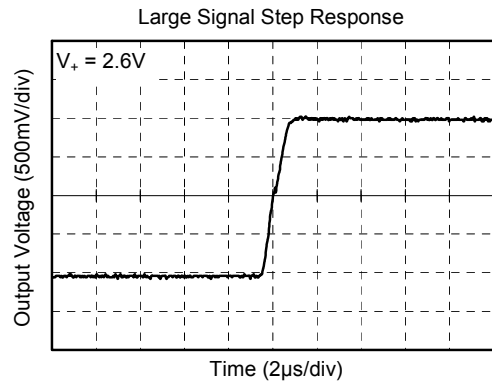
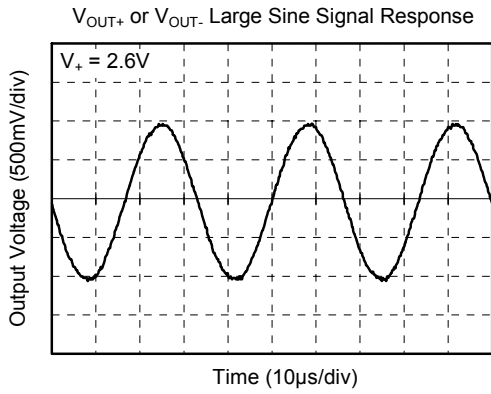

TYPICAL PERFORMANCE CHARACTERISTICS

V_{OUT+} or V_{OUT-} . Large Sine Signal Response

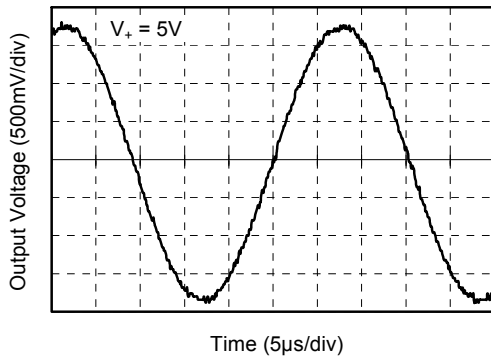

Large Signal Step Response

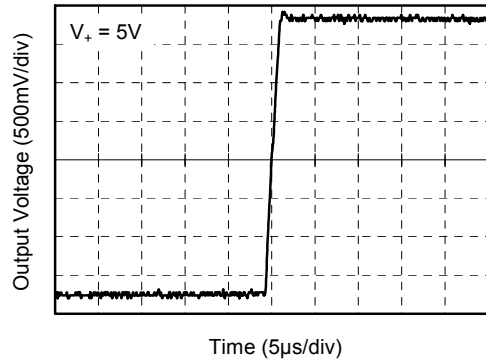

Small Signal Frequency Response

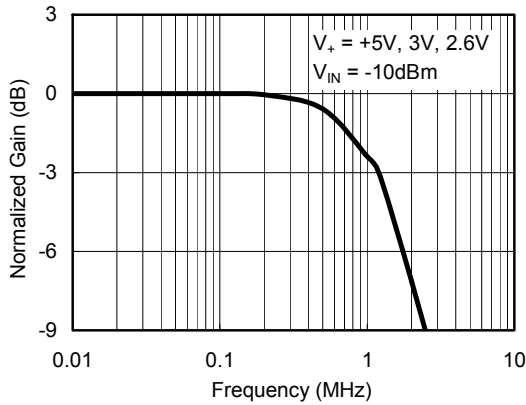

Quiescent Current vs. Temperature

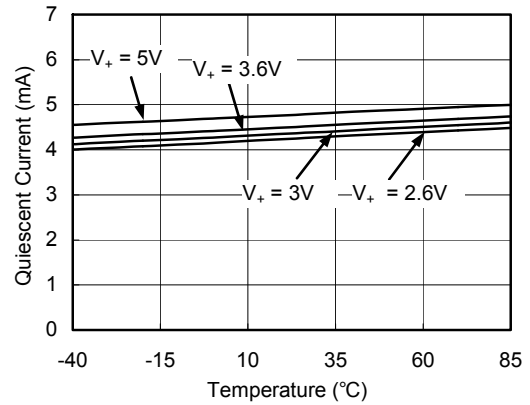

Output Offset Voltage vs. Temperature

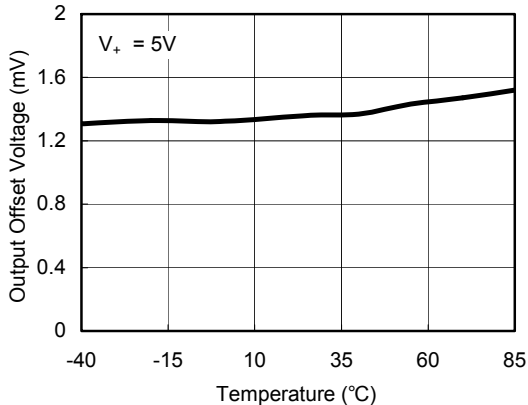

Supply Current vs. Shutdown Voltage

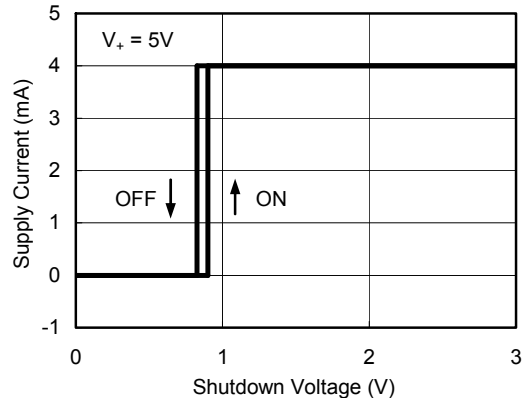

TYPICAL PERFORMANCE CHARACTERISTICS

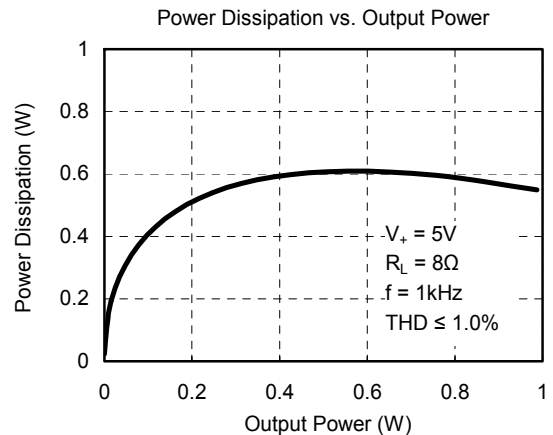
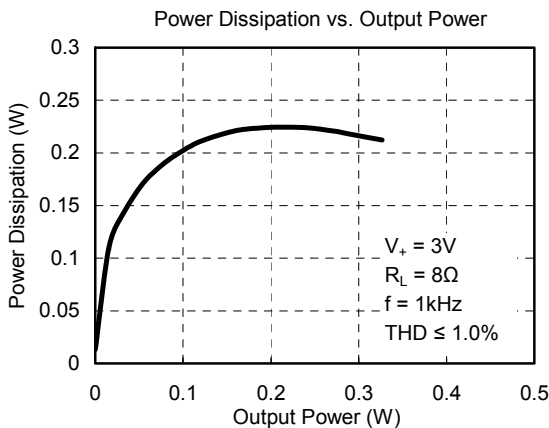
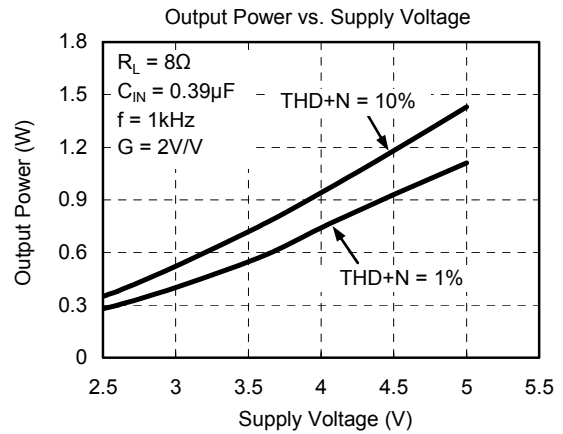
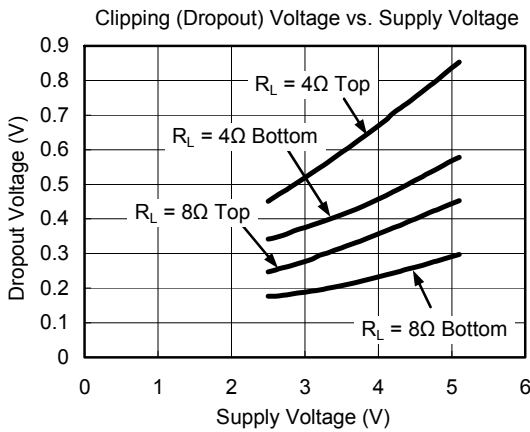
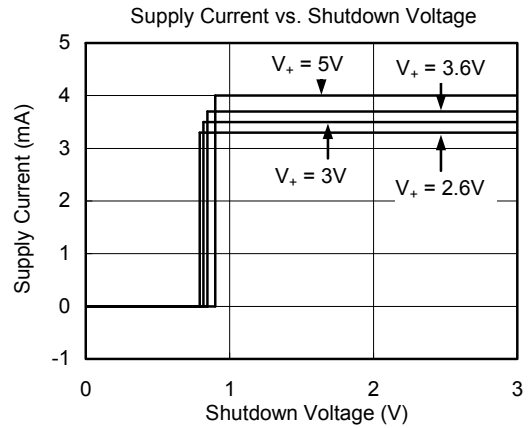
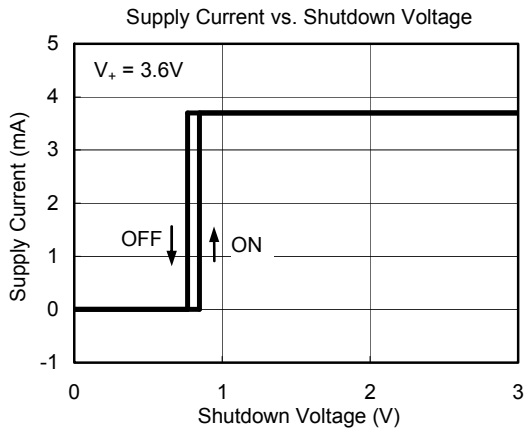

TYPICAL PERFORMANCE CHARACTERISTICS

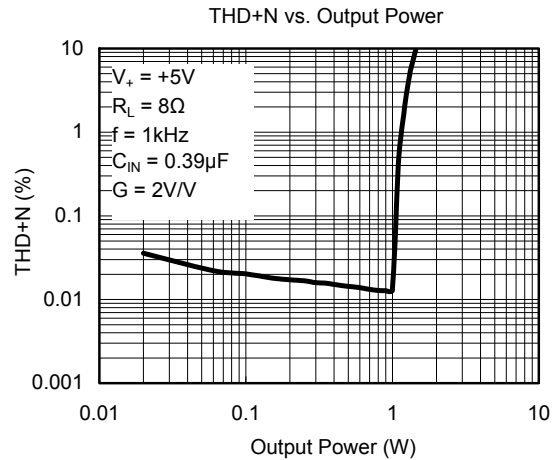
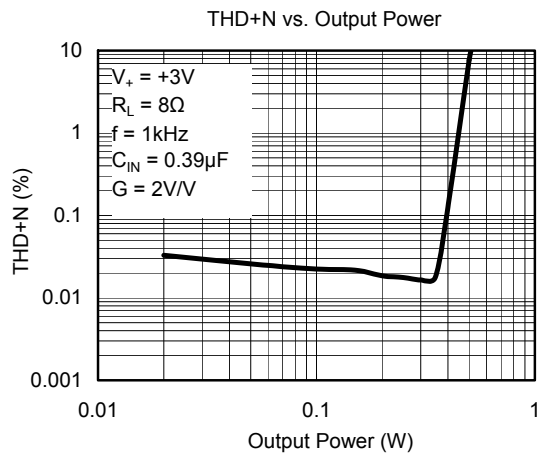
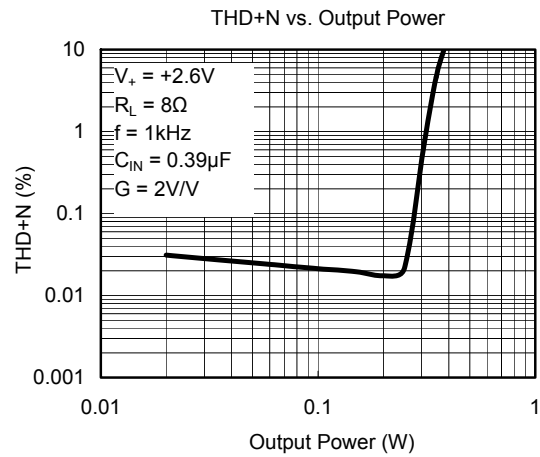
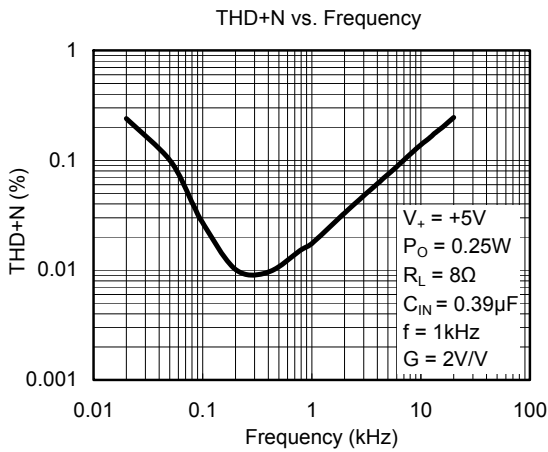
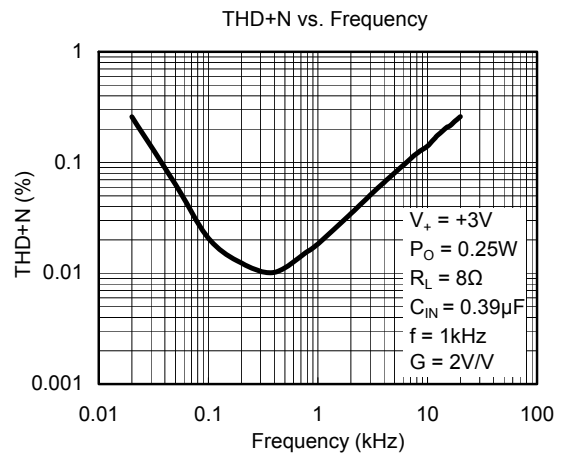
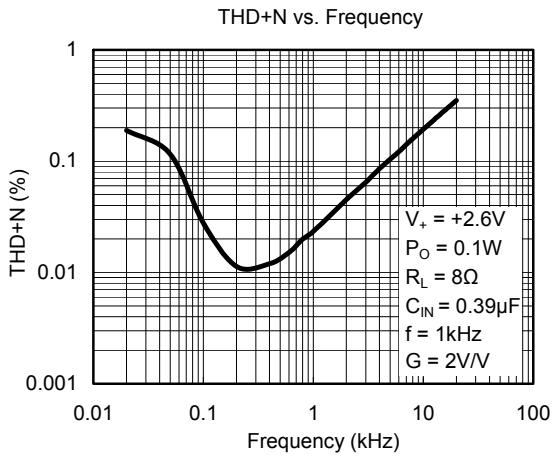

TYPICAL PERFORMANCE CHARACTERISTICS

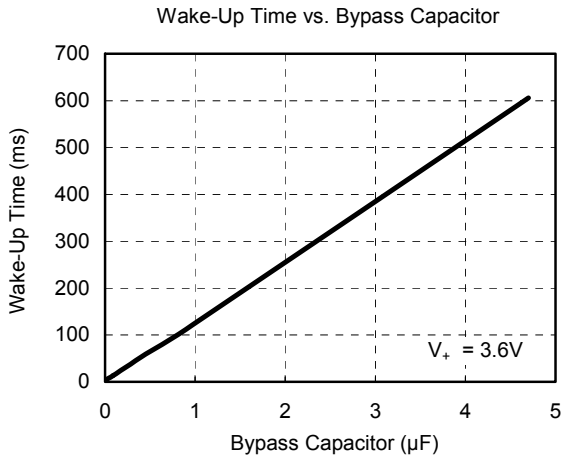

TYPICAL APPLICATION

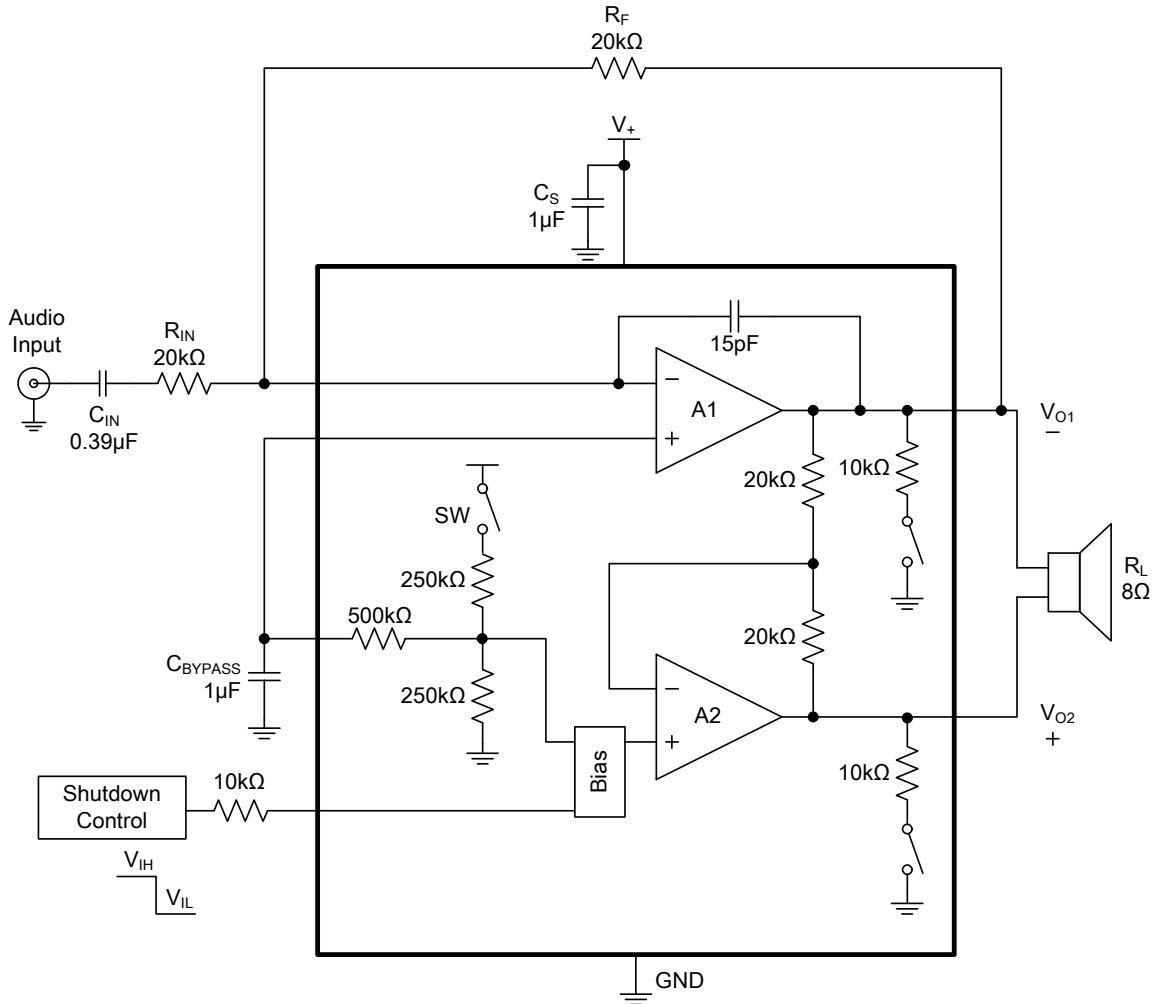

NOTE:
 1. A 10kΩ resistor must be serially connected to $\overline{\text{SHDN}}$ pin.

PACKAGE OUTLINE DIMENSIONS

MSOP-8

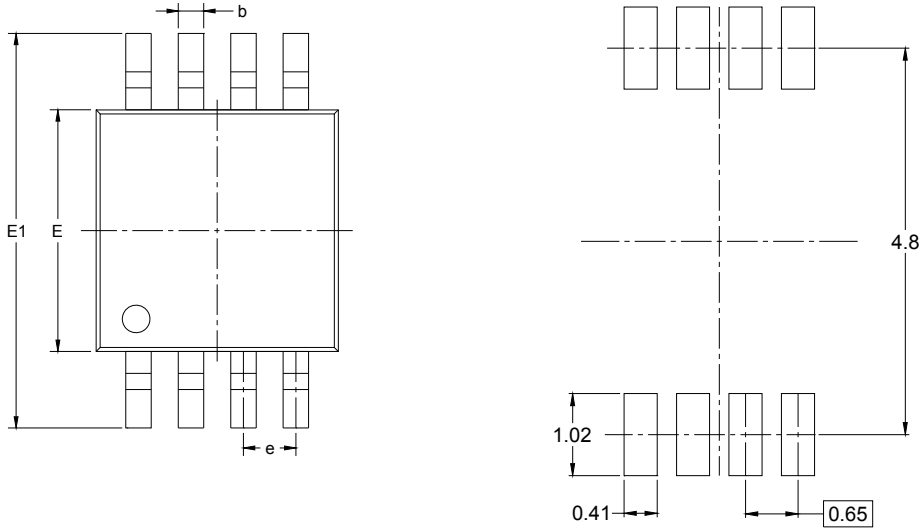

RECOMMENDED LAND PATTERN (Unit: mm)

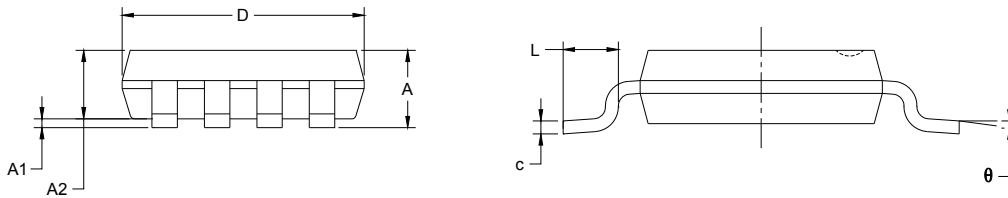

Symbol	Dimensions In Millimeters		Dimensions In Inches	
	MIN	MAX	MIN	MAX
A	0.820	1.100	0.032	0.043
A1	0.020	0.150	0.001	0.006
A2	0.750	0.950	0.030	0.037
b	0.250	0.380	0.010	0.015
c	0.090	0.230	0.004	0.009
D	2.900	3.100	0.114	0.122
E	2.900	3.100	0.114	0.122
E1	4.750	5.050	0.187	0.199
e	0.650 BSC		0.026 BSC	
L	0.400	0.800	0.016	0.031
θ	0°	6°	0°	6°

TAPE AND REEL INFORMATION

REEL DIMENSIONS

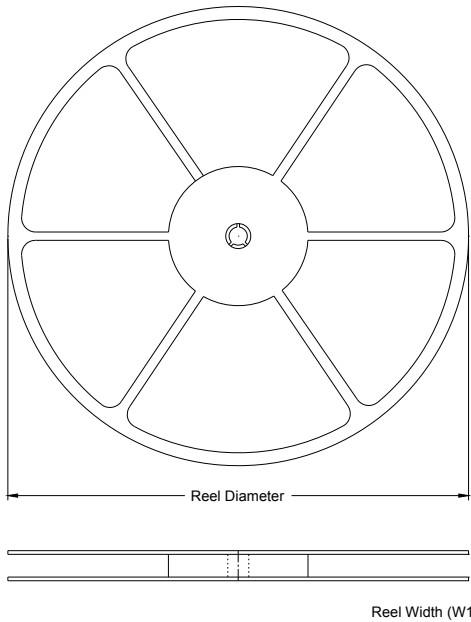

TAPE DIMENSIONS

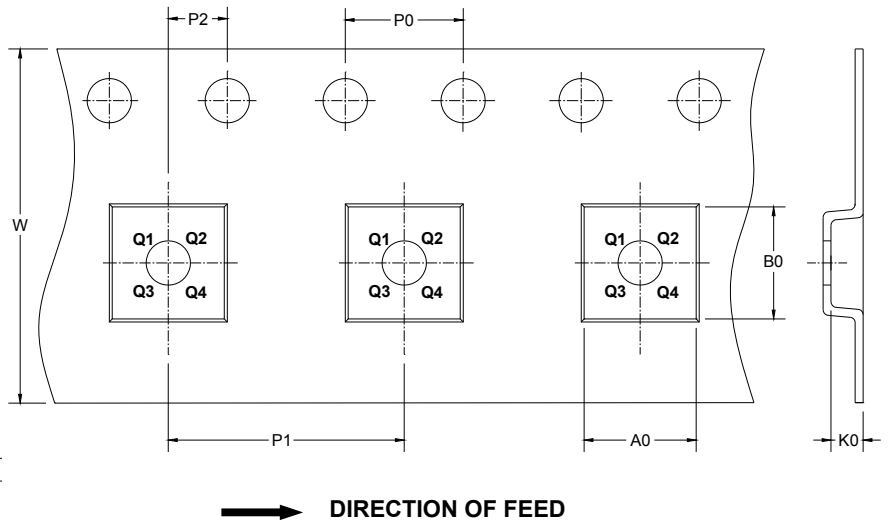

NOTE: The picture is only for reference. Please make the object as the standard.

KEY PARAMETER LIST OF TAPE AND REEL

Package Type	Reel Diameter	Reel Width W1 (mm)	A0 (mm)	B0 (mm)	K0 (mm)	P0 (mm)	P1 (mm)	P2 (mm)	W (mm)	Pin1 Quadrant
MSOP-8	13"	12.4	5.2	3.3	1.5	4.0	8.0	2.0	12.0	Q1

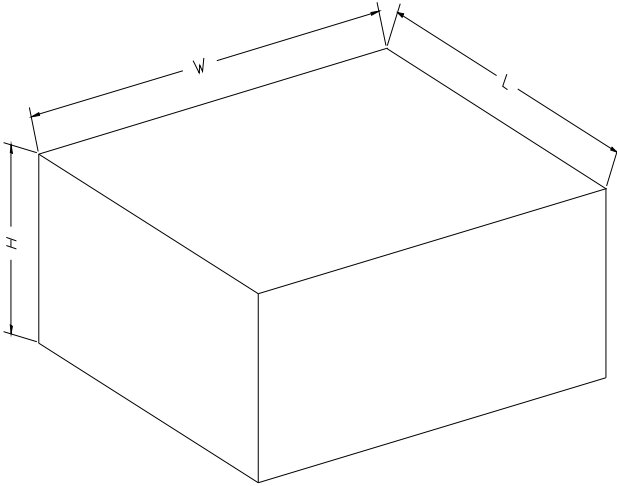
CARTON BOX DIMENSIONS

NOTE: The picture is only for reference. Please make the object as the standard.

KEY PARAMETER LIST OF CARTON BOX

Reel Type	Length (mm)	Width (mm)	Height (mm)	Pizza/Carton
13"	386	280	370	5