

### General Description

This planar stripe MOSFET has better characteristics, such as fast switching time, fast reverse recovery time, low on resistance, low gate charge and excellent avalanche characteristics. It is mainly suitable for electronic ballast and switching mode power supplies.

### FEATURES

- $V_{DSS} = 500V$ ,  $I_D = 2.5A$
- Drain-Source ON Resistance :  $R_{DS(ON)} = 2.5\Omega$  (Max) @  $V_{GS} = 10V$
- $Q_g(\text{typ}) = 7.50nC$

### MAXIMUM RATING (Tc=25°C)

| CHARACTERISTIC                          |                        | SYMBOL     | RATING    | UNIT |
|---|------------------------|------------|-----------|------|
| Drain-Source Voltage                    |                        | $V_{DSS}$  | 500       | V    |
| Gate-Source Voltage                     |                        | $V_{GSS}$  | $\pm 30$  | V    |
| Drain Current                           | @T <sub>C</sub> =25°C  | $I_D$      | 2.5       | A    |
|   | @T <sub>C</sub> =100°C |            | 1.5       |      |
|   | Pulsed (Note1)         | $I_{DP}$   | 7         |      |
| Single Pulsed Avalanche Energy (Note 2) |                        | $E_{AS}$   | 110       | mJ   |
| Repetitive Avalanche Energy (Note 1)    |                        | $E_{AR}$   | 4         | mJ   |
| Peak Diode Recovery dv/dt (Note 3)      |                        | dv/dt      | 10        | V/ns |
| Drain Power Dissipation                 | Tc=25°C                | $P_D$      | 40        | W    |
|   | Derate above 25°C      |            | 0.32      | W/°C |
| Maximum Junction Temperature            |                        | $T_j$      | 150       | °C   |
| Storage Temperature Range               |                        | $T_{stg}$  | -55 ~ 150 | °C   |
| <b>Thermal Characteristics</b>          |                        |            |           |      |
| Thermal Resistance, Junction-to-Case    |                        | $R_{thJC}$ | 3.1       | °C/W |
| Thermal Resistance, Junction-to-Ambient |                        | $R_{thJA}$ | 110       | °C/W |

### PIN CONNECTION

(KF3N50DZ/IZ)

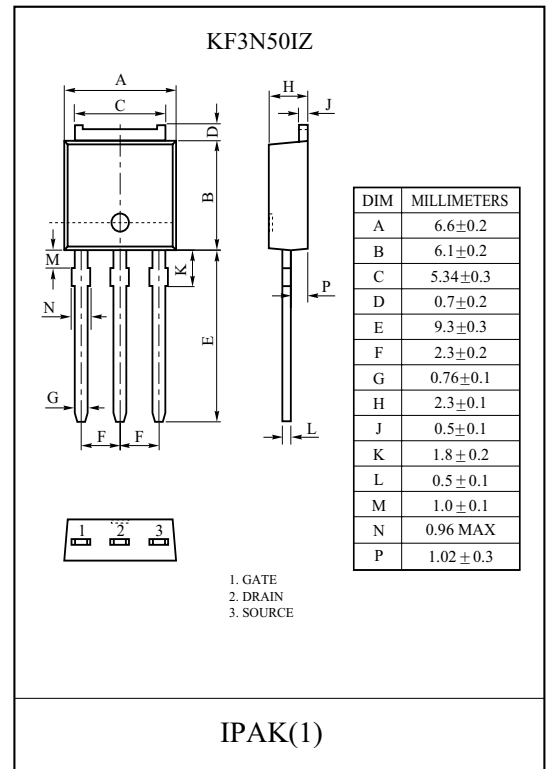
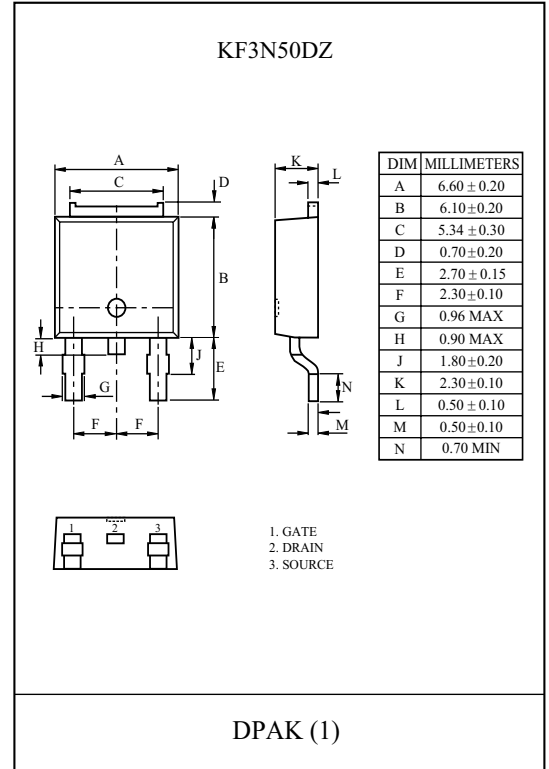
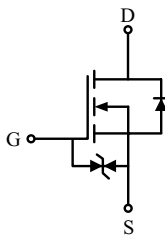

# KF3N50DZ/IZ

## ELECTRICAL CHARACTERISTICS (Tc=25 °C)

| CHARACTERISTIC                            | SYMBOL                       | TEST CONDITION  | MIN. | TYP. | MAX.     | UNIT     |
|---|------------------------------|---|------|------|----------|----------|
| <b>Static</b>                             |                              |   |      |      |          |          |
| Drain-Source Breakdown Voltage            | $BV_{DSS}$                   | $I_D=250\mu A, V_{GS}=0V$                             | 500  | -    | -        | V        |
| Breakdown Voltage Temperature Coefficient | $\Delta BV_{DSS}/\Delta T_j$ | $I_D=250\mu A$ , Referenced to 25 °C                  | -    | 0.55 | -        | V/°C     |
| Drain Cut-off Current                     | $I_{DSS}$                    | $V_{DS}=500V, V_{GS}=0V$ ,                            | -    | -    | 10       | $\mu A$  |
| Gate Threshold Voltage                    | $V_{th}$                     | $V_{DS}=V_{GS}, I_D=250\mu A$                         | 2.5  | -    | 4.5      | V        |
| Gate Leakage Current                      | $I_{GSS}$                    | $V_{GS}=\pm 25V, V_{DS}=0V$                           | -    | -    | $\pm 10$ | $\mu A$  |
| Drain-Source ON Resistance                | $R_{DS(ON)}$                 | $V_{GS}=10V, I_D=1.25A$                               | -    | 2.0  | 2.5      | $\Omega$ |
| <b>Dynamic</b>                            |                              |   |      |      |          |          |
| Total Gate Charge                         | $Q_g$                        | $V_{DS}=400V, I_D=3A$<br>$V_{GS}=10V$ (Note4,5)       | -    | 8.0  | -        | nC       |
| Gate-Source Charge                        | $Q_{gs}$                     |   | -    | 2.0  | -        |          |
| Gate-Drain Charge                         | $Q_{gd}$                     |   | -    | 3.5  | -        |          |
| Turn-on Delay time                        | $t_{d(on)}$                  | $V_{DD}=250V$<br>$I_D=3A$<br>$R_G=25\Omega$ (Note4,5) | -    | 15   | -        | ns       |
| Turn-on Rise time                         | $t_r$                        |   | -    | 20   | -        |          |
| Turn-off Delay time                       | $t_{d(off)}$                 |   | -    | 25   | -        |          |
| Turn-off Fall time                        | $t_f$                        |   | -    | 20   | -        |          |
| Input Capacitance                         | $C_{iss}$                    | $V_{DS}=25V, V_{GS}=0V, f=1.0MHz$                     | -    | 350  | -        | pF       |
| Output Capacitance                        | $C_{oss}$                    |   | -    | 45   | -        |          |
| Reverse Transfer Capacitance              | $C_{rss}$                    |   | -    | 4.5  | -        |          |
| <b>Source-Drain Diode Ratings</b>         |                              |   |      |      |          |          |
| Continuous Source Current                 | $I_S$                        | $V_{GS}<V_{th}$                                       | -    | -    | 3        | A        |
| Pulsed Source Current                     | $I_{SP}$                     |   | -    | -    | 12       |          |
| Diode Forward Voltage                     | $V_{SD}$                     | $I_S=2.5A, V_{GS}=0V$                                 | -    | -    | 1.4      | V        |
| Reverse Recovery Time                     | $t_{rr}$                     | $I_S=3A, V_{GS}=0V$ ,<br>$dI_S/dt=100A/\mu s$         | -    | 300  | -        | ns       |
| Reverse Recovery Charge                   | $Q_{rr}$                     |   | -    | 1.1  | -        | $\mu C$  |

Note 1) Repetivity rating : Pulse width limited by junction temperature.

Note 2)  $L=22mH, I_S=3A, V_{DD}=50V, R_G=25\Omega$ , Starting  $T_j=25^\circ C$ .

Note 3)  $I_S \leq 3A, dI/dt \leq 100A/\mu s, V_{DD} \leq BV_{DSS}$ , Starting  $T_j=25^\circ C$ .

Note 4) Pulse Test : Pulse width  $\leq 300\mu s$ , Duty Cycle  $\leq 2\%$ .

Note 5) Essentially independent of operating temperature.

## Marking

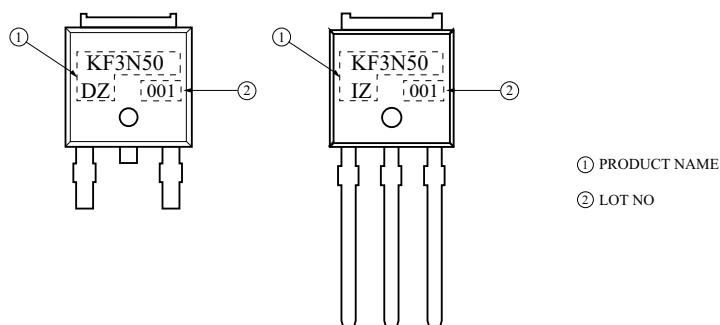

# KF3N50DZ/AZ

Fig1.  $I_D - V_{DS}$

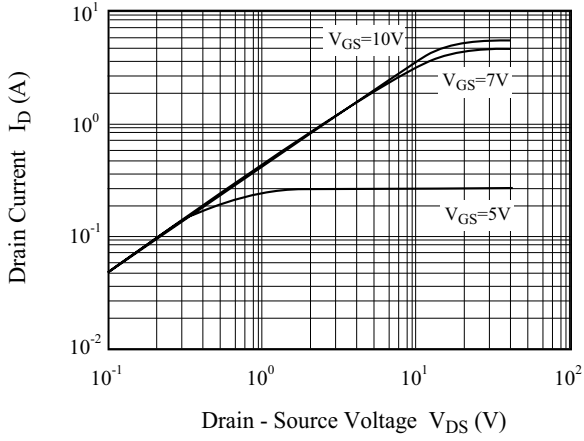

Fig2.  $I_D - V_{GS}$

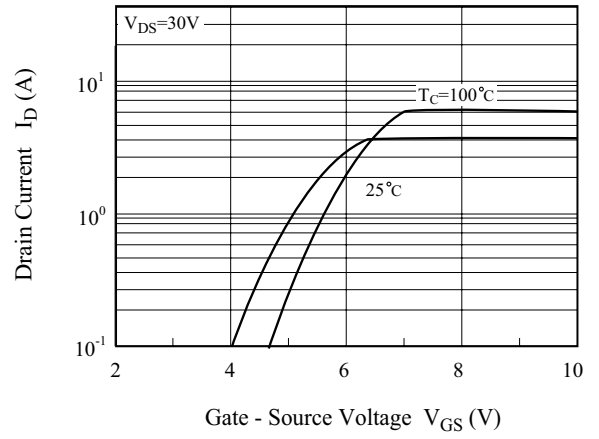

Fig3.  $BV_{DSS} - T_j$

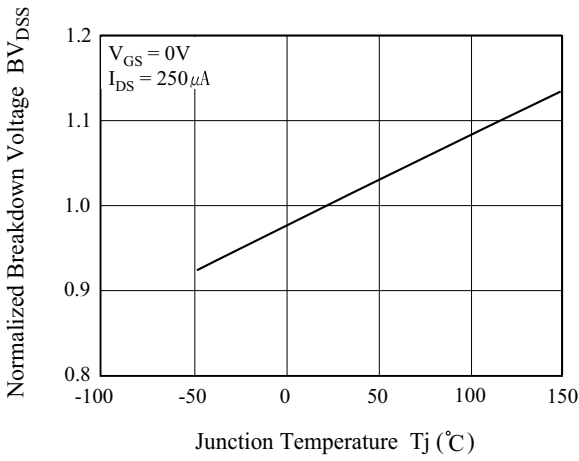

Fig4.  $R_{DS(ON)} - I_D$

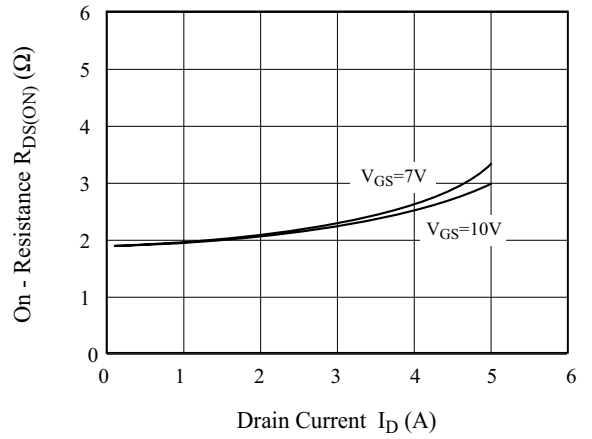

Fig5.  $I_S - V_{SD}$

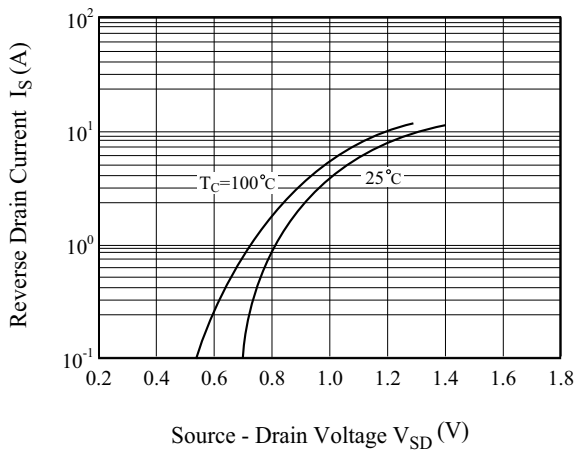
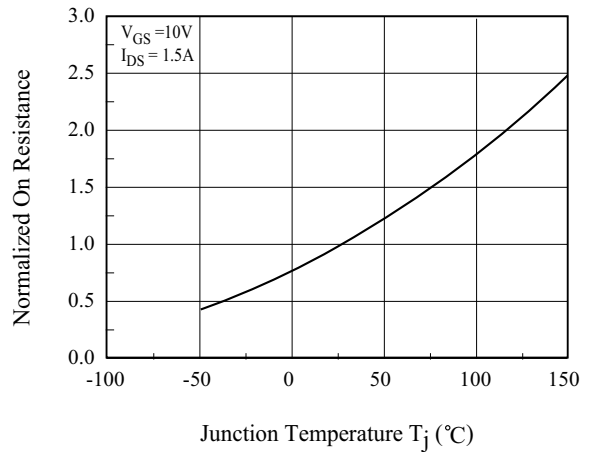

Fig6.  $R_{DS(ON)} - T_j$



# KF3N50DZ/IZ

Fig 7. C - V<sub>DS</sub>

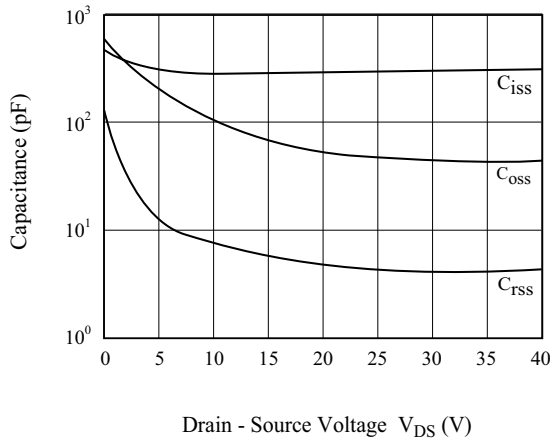

Fig8. Q<sub>g</sub>- V<sub>GS</sub>

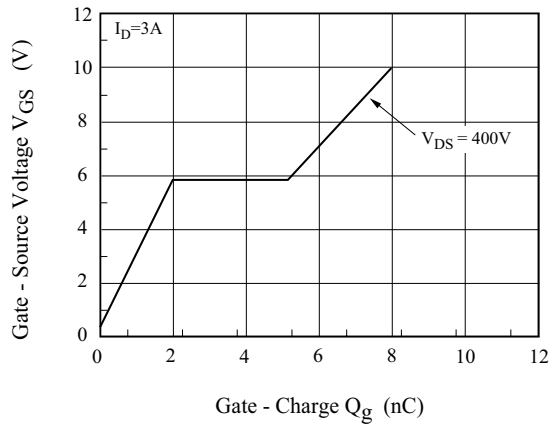

Fig9. Safe Operation Area

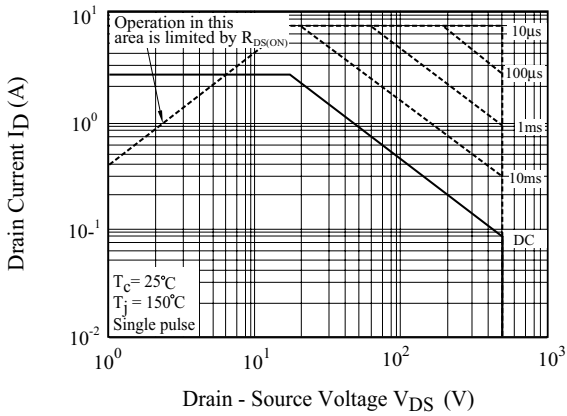

Fig10. I<sub>D</sub> - T<sub>j</sub>

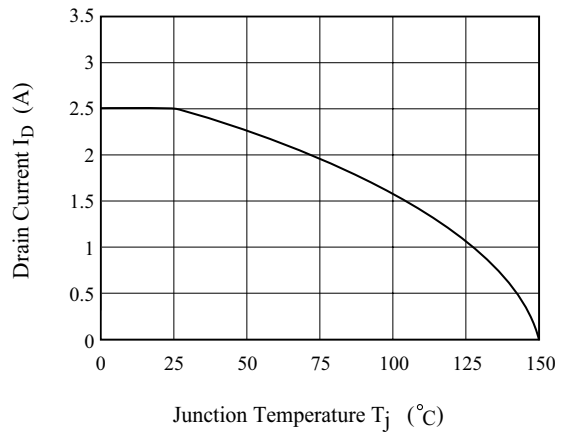
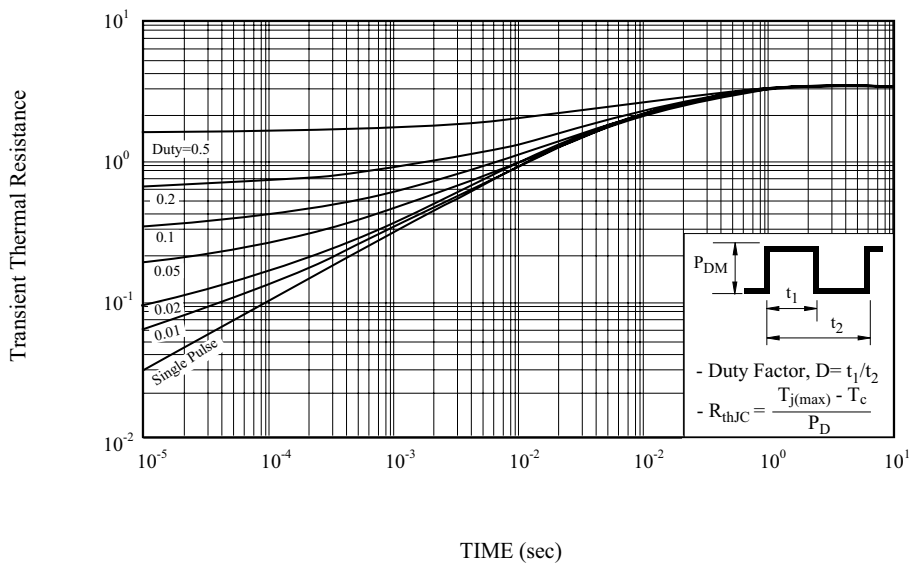

Fig11. Transient Thermal Response Curve



# KF3N50DZ/IZ

Fig12. Gate Charge

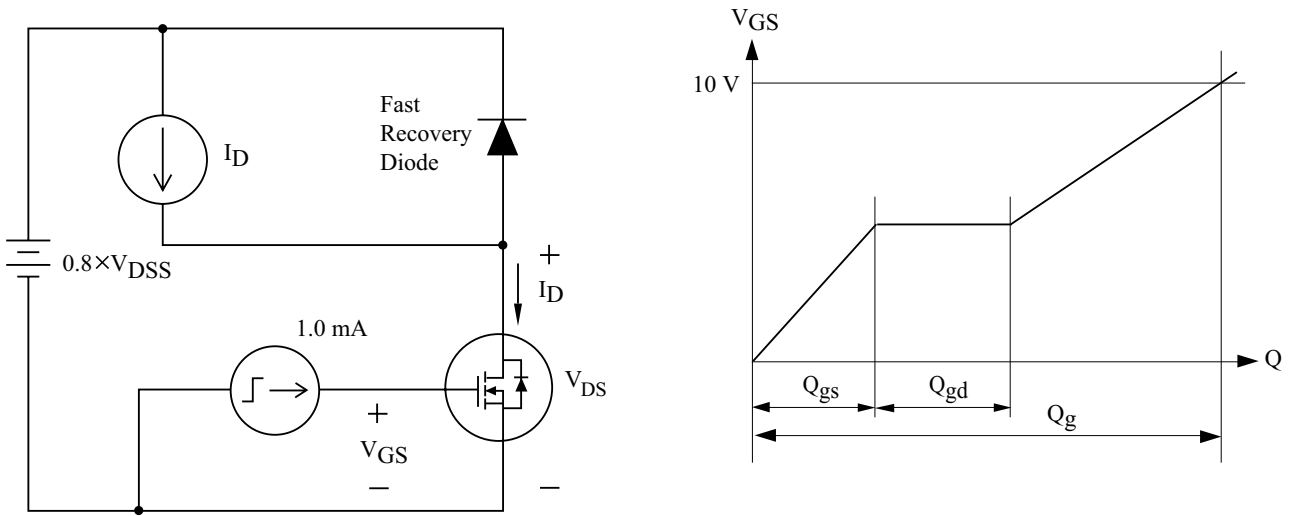

Fig13. Single Pulsed Avalanche Energy

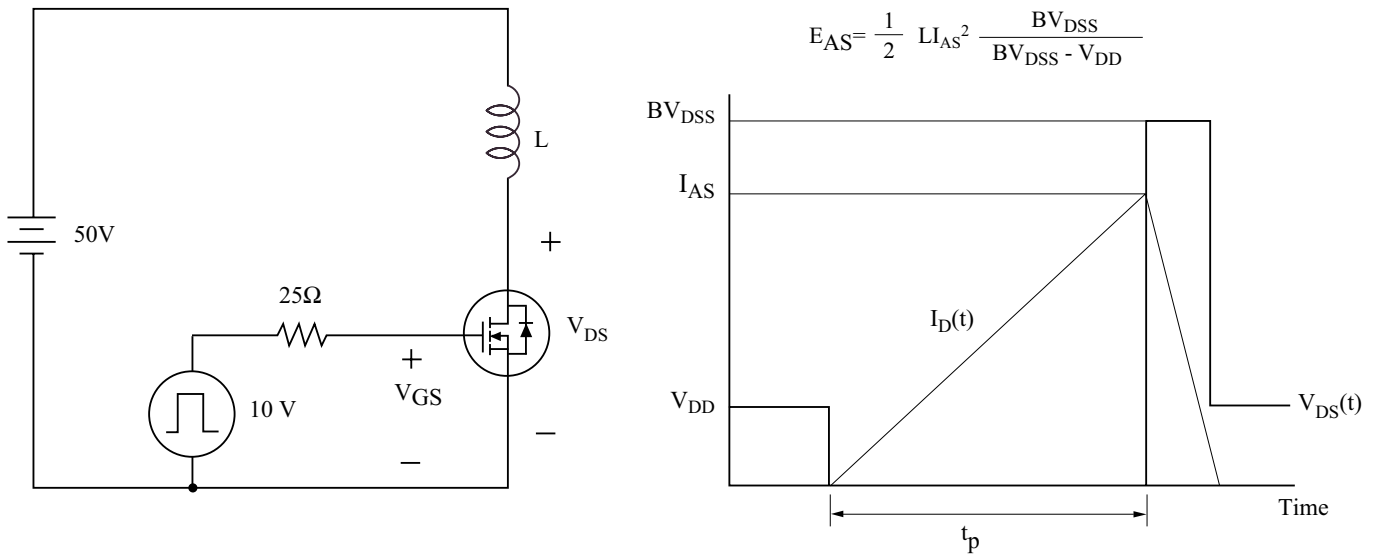

Fig14. Resistive Load Switching

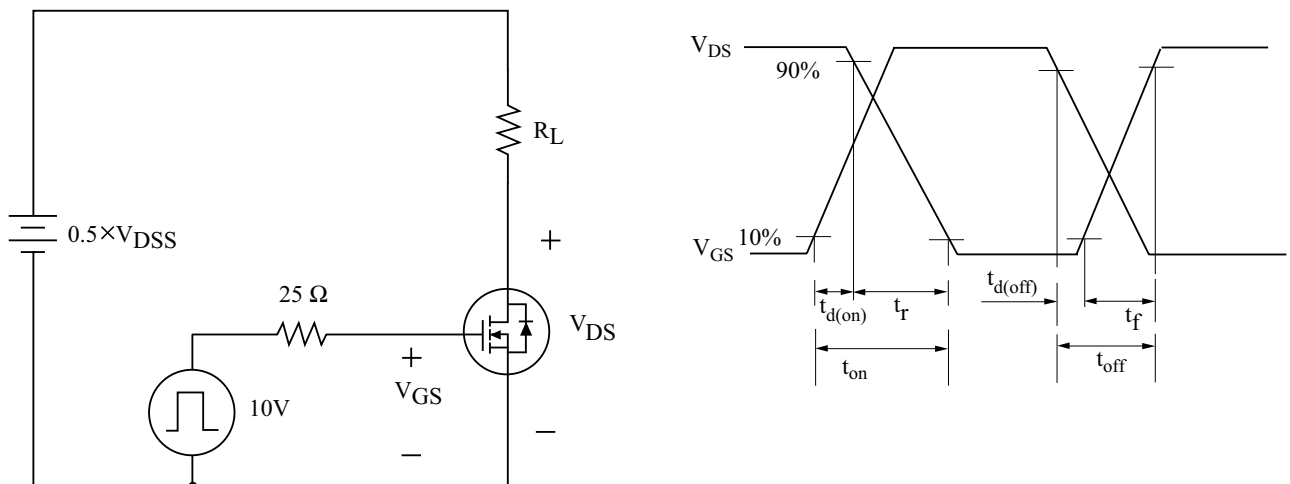

Fig15. Source - Drain Diode Reverse Recovery and  $dv/dt$

