

Typical Specifications

Items		Specifications
Rating (max.)/(min.) (Resistive load)		0.1A 30V DC / 10 μ A 1V DC
Contact resistance (Initial performance / After lifetime)		25m Ω max. / 65m Ω max.
Operating force		Refer to the dimensions.
Operating life	Without load	10,000 cycles
	With load	10,000 cycles (0.1A 30V DC)

Product Line

Travel (mm)	Actuator direction	Actuator length (mm)	Poles	Positions	Mounting method	Changeover timing	Soldering	Minimum order unit (pcs.)		Products No.	Drawing No.	
								Japan	Export			
3	Vertical	6	1	2	Snap-in (t1.6)	Non shorting	Manual, Dip	100	2,000	SSSU011700	1	
										SSSU012200		
		9	3	2,500					SSSU014800	2		
									SSSU015100			
		6	2	2,000					SSSU022400	3		
									SSSU022800			
		9	3	2,500					SSSU025800	4		
									SSSU026300			
	6	4	2						SSSU041700	5		
									SSSU042100			
	Horizontal	6	1						3	3,500	SSSU111400	6
										2,500	SSSU113200	7
		9	2						2	3,500	SSSU121700	8
										SSSU122200		
		3	3	2,000					SSSU124900	9		

Note

Please contact us for automotive use.

Packing Specifications

Bulk

Products No.	Number of packages (pcs.)		Export package measurements (mm)
	1 case / Japan	1 case / export packing	
SSSU011700, SSSU012200, SSSU022400, SSSU022800, SSSU124900	400	2,000	400×270×290
SSSU014800, SSSU015100, SSSU025800, SSSU042100, SSSU026300, SSSU041700, SSSU113200	500	2,500	
SSSU111400, SSSU121700, SSSU122200	700	3,500	

SSSU 8.5(H)mm, 3mm-travel Type

■ Dimensions

Vertical Actuator Type

Unit:mm

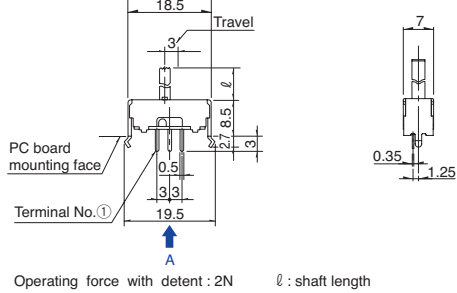
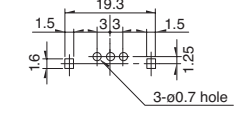
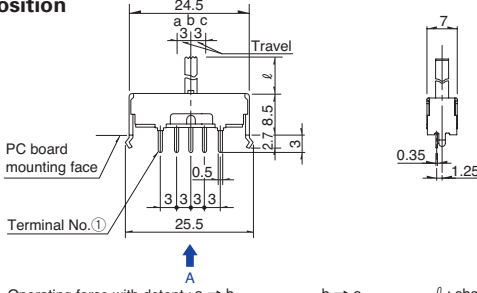
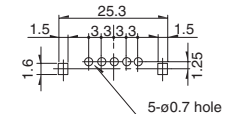
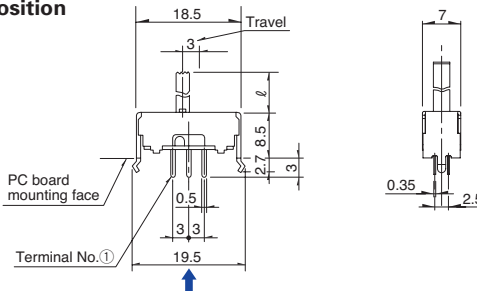
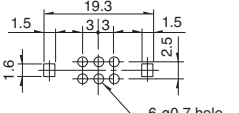
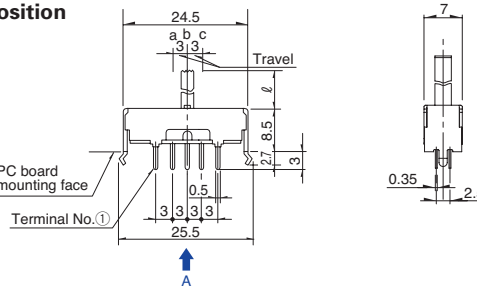
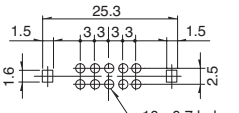
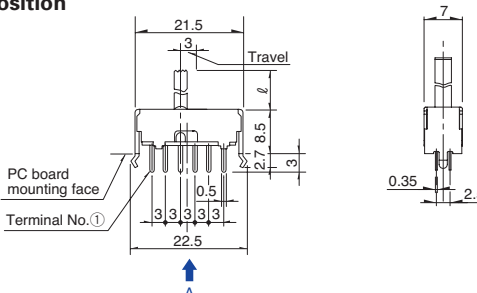
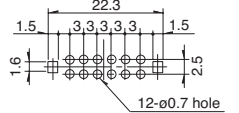
No.	Style	PC board mounting hole dimensions (Viewed from direction A)
1	1-pole, 2-position  <p>Operating force with detent : 2N l : shaft length</p>	 <p>3-ϕ0.7 hole</p>
2	1-pole, 3-position  <p>Operating force with detent : a \rightarrow b } 1.5N b \rightarrow a } 2N c \rightarrow b } 2N l : shaft length</p>	 <p>5-ϕ0.7 hole</p>
3	2-pole, 2-position  <p>Operating force with detent : 2N l : shaft length</p>	 <p>6-ϕ0.7 hole</p>
4	2-pole, 3-position  <p>Operating force with detent : a \rightarrow b } 1.5N b \rightarrow a } 2N c \rightarrow b } 2N l : shaft length</p>	 <p>10-ϕ0.7 hole</p>
5	4-pole, 2-position  <p>Operating force with detent : 2N l : shaft length</p>	 <p>12-ϕ0.7 hole</p>

■ Dimensions

Horizontal Actuator Type

Unit:mm

No.	Style	PC board mounting hole dimensions (Viewed from direction A)
6	<p>1-pole, 2-position</p> <p>Operating force with detent : 2N l : shaft length</p>	<p>3-ø0.7 hole</p>
7	<p>1-pole, 3-position</p> <p>Operating force with detent : $a \rightarrow b$ } 1.5N $b \rightarrow a$ } 2N $c \rightarrow b$ } 1.5N $b \rightarrow c$ } 2N l : shaft length</p>	<p>5-ø0.7 hole</p>
8	<p>2-pole, 2-position</p> <p>Operating force with detent : 2N l : shaft length</p>	<p>6-ø0.7 hole</p>
9	<p>2-pole, 3-position</p> <p>Operating force with detent : $a \rightarrow b$ } 1.5N $b \rightarrow a$ } 2N $c \rightarrow b$ } 1.5N $b \rightarrow c$ } 2N l : shaft length</p>	<p>10-ø0.7 hole</p>

Detector

Slide

Push

Rotary

Power

Dual-In-line
Package Type

Small size
General Use Type

Big size
General Use Type

Circuit Diagram (Viewed from Direction A)

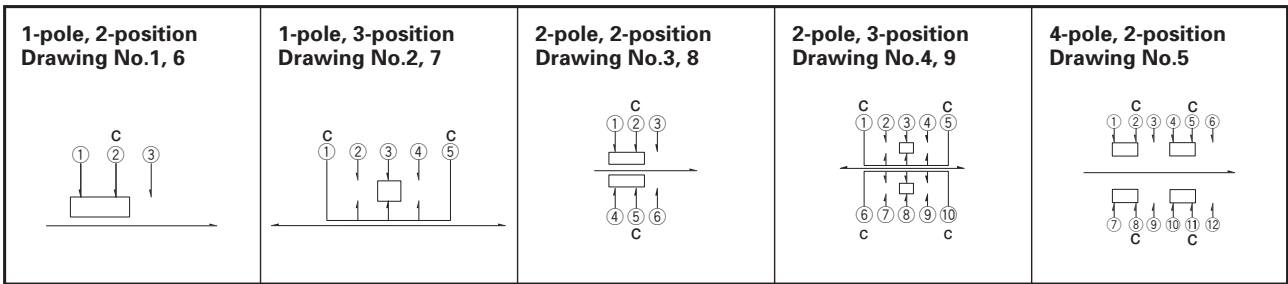

Actuator Configuration

Unit:mm

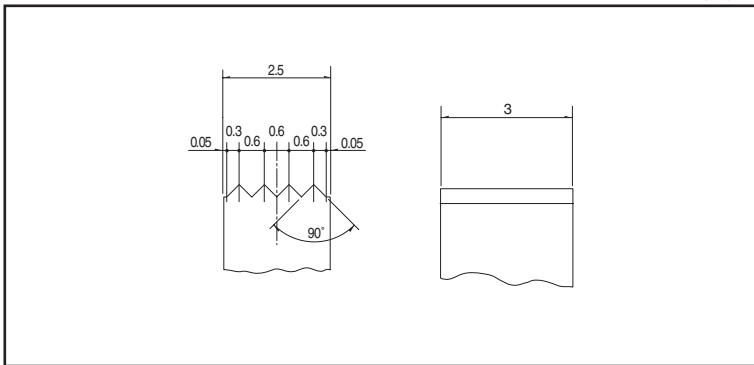





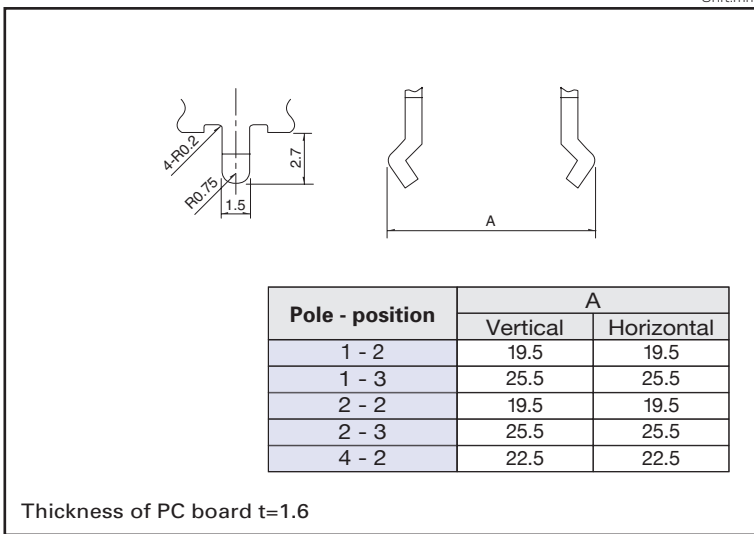





Shape of Frame Leg

Unit:mm



Slide Switches

List of Varieties

Series		SSSS2※1	SSSS9	SSAC	SSSF※2	SSSU※2
Photo						
Actuator direction	Horizontal	●	●	●	●	●
	Vertical	●	●	—	●	●
Poles-positions	1-2	●	●	—	●	●
	1-3	●	●	—	●	●
	1-4	●	—	—	—	—
	2-2	●	●	●	●	●
	2-3	●	●	●	●	●
	2-4	●	—	—	—	—
	4-2	—	—	—	●	●
Travel (mm)		2	2	1.5	2	3
Operating temperature range		-40°C to +85°C		-10°C to +60°C	-40°C to +85°C	
Automotive use		—	—	—	—	—
Life cycle						
Rating (max.) (Resistive load)		0.3A 6V DC	0.1A 12V DC	1mA 5V DC	0.1A 30V DC	
Rating (min.) (Resistive load)		50μA 3V DC	1mA 5V DC	50μA 3V DC	10μA 1V DC	
Durability	Operating life without load	10,000 cycles 100mΩ max.*1	10,000 cycles 60mΩ max.	10,000 cycles 200mΩ max.	10,000 cycles 45mΩ max.	
	Operating life with load Load: as rating	10,000 cycles 130mΩ max.*1	10,000 cycles 80mΩ max.		10,000 cycles 65mΩ max.	
Electrical performance	Initial contact resistance	70mΩ max.	30mΩ max.	100mΩ max.	25mΩ max.	
	Insulation resistance	100MΩ min. 500V DC		100MΩ min. 100V DC	100MΩ min. 500V DC	
	Voltage proof	500V AC for 1minute		100V AC for 1minute	500V AC for 1minute	
Mechanical performance	Terminal strength		3N for 1minute		5N for 1minute	
	Actuator strength	Operating direction	20N	30N	5N	30N
		Pulling direction	10N			
Environmental performance	Cold	-20°C 500h	-40°C 500h	-20°C 96h	-40°C 500h	
	Dry heat	85°C 500h		85°C 96h	85°C 500h	
	Damp heat	60°C, 90 to 95%RH 500h		40°C, 90 to 95%RH 96h	60°C, 90 to 95%RH 500h	
Page		90	95	101	103	107

Slide Switches Soldering Conditions	111
Slide Switches Cautions	112

Note

- ※ 1. Operating life for SSSS213202 is 100 cycles.
- ※ 2. The operating temperature range for automotive applications can be raised upon request. Please contact us for details.
- Indicates applicability to all products in the series.

Slide Switches Soldering Conditions

Example of Reflow Soldering Condition

1. Heating method: Double heating method with infrared heater.
2. Temperature measurement: Thermocouple ϕ 0.1 to 0.2 CA (K) or CC (T) at soldering portion (copper foil surface).
A heat resisting tape should be used for fixed measurement.
3. Temperature profile

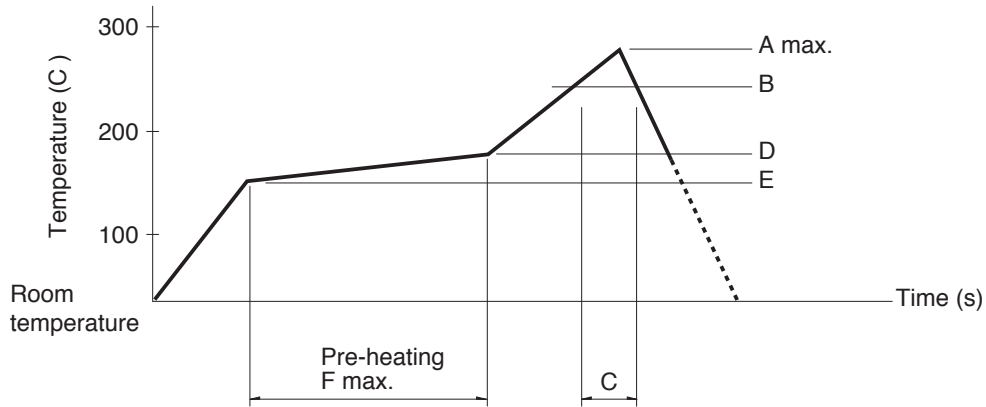

Series (Reflow type)		A (°C) 3s max.	B (°C)	C (s)	D (°C)	E (°C)	F (s)
SSSS2	Vertical 1-pole, 3-position	260	230	40	180	150	120
	Horizontal 1-pole, 2-position 1-pole, 3-position 2-pole, 3-position						
	Vertical 1-pole, 2-position	250					
SSSS7		260					
SSAH, SSAG, SSAJ, SSAL, SSSS8		260					

Notes

1. The condition mentioned above is the temperature on the mounting surface of a PC board. There are cases where the PC board's temperature greatly differs from that of the switch, depending on the PC board's material, size, thickness, etc. The above-stated conditions shall also apply to switch surface temperatures.
2. Soldering conditions differ depending on reflow soldering machines. Prior verification of soldering condition is highly recommended.

Reference for Hand Soldering

Series	Soldering temperature	Soldering time
SSSF, SSSU	350±10°C	3+1/0s
SSSS2	350±10°C	4s max.
SSSS9	350±10°C	3s max.
SSAH, SSAG, SSAJ, SSAL	350±5°C	3s max.
SSSS8	330±5°C	3s max.
SSSS7	320±5°C	3s max.
SSAC	300±10°C	2s max.

Reference for Dip Soldering

(For PC board terminal types)

Series	Items		Dip soldering	
	Preheating temperature	Preheating time	Soldering temperature	Duration of immersion
SSSS2	100°C max.	60s max.	260±5°C	3±1s
SSSS9	120°C max.	60s max.	260±5°C	5+0/-1s (2 times)
SSSF, SSSU	100°C max.	60s max.	260±5°C	10±1s/5±1s
SSAC	100°C max.	60s max.	260±5°C	5±1s