

## GaAs SP3T Switch DC - 3.5 GHz

Rev. V2

### Features

- Low Insertion Loss: 0.55 dB @ 2.45 GHz
- High P1dB: 35 dBm @ 2.6 V
- 0.5 micron GaAs pHEMT Process
- Lead-Free 2 mm 8-Lead PDFN Package
- Halogen-Free “Green” Mold Compound
- 260°C Reflow Compatible
- Low gate lag for timing sensitive applications
- 1.8 V Operation with 1.8 V on Voltage Pull Up

### Description

M/A-COM’s MASW-008955 is a GaAs pHEMT MMIC single pole three throw (SP3T) switch in a lead-free 2 mm 8-lead PDFN package. The MASW-008955 is ideally suited for applications where low control voltage, low insertion loss, high isolation, small size, and low cost are required.

Typical applications are for filter and antenna switching in WLAN or Bluetooth systems that connect separate receive functions to a common antenna. This part can be used in all systems operating up to 3.5 GHz requiring low control voltage.

The MASW-008955 is fabricated using a 0.5 micron gate length GaAs pHEMT process. The process features full passivation for performance and reliability.

### Application Schematic

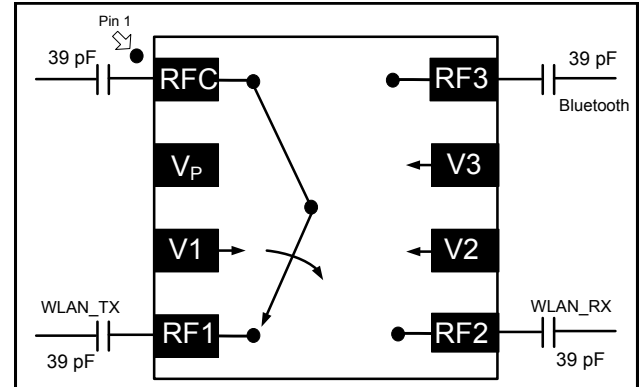

### Pin Configuration

Pin No.	Function	Description
1	RFC	RF In/Out
2	$V_P^{3,4}$	Optional Voltage Pull Up
3	$V1^3$	Control 1
4	RF1	RF In/Out
5	RF2	RF In/Out
6	$V2^3$	Control 2
7	$V3^3$	Control 3
8	RF3	RF In/Out

3. Depending on system sensitivity optional DC line bypass capacitors (22 pF) may be used.
4. Improved linearity at low control voltage can be obtained by tying pin 2 to the most positive control voltage. Otherwise, leave pin 2 unconnected.

### Ordering Information<sup>1,2</sup>

Part Number	Package
MASW-008955-TR1000	1000 piece reel
MASW-008955-TR3000	3000 piece reel
MASW-008955-001SMB	Sample Test Board

1. Reference Application Note M513 for reel size information.
2. All sample boards include 5 loose parts.

### Absolute Maximum Ratings<sup>5,6</sup>

Parameter	Absolute Maximum
Max Input Power (0.5-3.5 GHz, 2.6 V Control)	
RFC – RF1	35 dBm
RFC – RF2	31 dBm
RFC – RF3	31 dBm
$ V_{HI}-V_{LO} $	8.5 volts
Operating Temperature	-40°C to +85°C
Storage Temperature	-65°C to +150°C

5. Exceeding any one or combination of these limits may cause permanent damage to this device.
6. M/A-COM does not recommend sustained operation near these survivability limits.

\* Restrictions on Hazardous Substances, European Union Directive 2002/95/EC.

## GaAs SP3T Switch DC - 3.5 GHz

Rev. V2

Electrical Specifications:  $T_A = 25^\circ\text{C}$ ,  $V_C = 0\text{ V} / 2.6\text{ V}$ ,  $Z_0 = 50\ \Omega$  <sup>7,9</sup>

Parameter	Test Conditions	Units	Min.	Typ.	Max.
Insertion Loss <sup>8</sup>	2.45 GHz, RFC - RF1	dB	—	0.55	0.85
	2.45 GHz, RFC - RF2		—	0.6	0.85
	2.45 GHz, RFC - RF3		—	0.6	0.85
Isolation	2.45 GHz, RFC - RF1	dB	20	22	—
	2.45 GHz, RFC - RF2		20	22	—
	2.45 GHz, RFC - RF3		19	20	—
Return Loss	2.45 GHz	dB	—	20	—
IP3	Two Tone, +10 dBm/tone, 10 MHz Spacing, 2.45 GHz	dBm	—	54	—
IP2	Two Tone, +10 dBm/tone, 10 MHz Spacing, 2.45 GHz	dBm	—	98	—
P0.1dB	2.45 GHz (RF1), 2.6 V	dBm	—	29	—
	2.45 GHz (RF2), 2.6 V			25	
	2.45 GHz (RF3), 2.6 V			25	
	2.45 GHz (RF1), 3 V			32	
	2.45 GHz (RF2), 3 V			28	
	2.45 GHz (RF3), 3 V			28	
P1dB	2.45 GHz (RF1), 2.6 V	dBm	—	35	—
	2.45 GHz (RF2), 2.6 V			31	
	2.45 GHz (RF3), 2.6 V			31	
	2.45 GHz (RF1), 3 V			36	
	2.45 GHz (RF2), 3 V			34	
	2.45 GHz (RF3), 3 V			34	
2nd Harmonic	900 MHz, 2.6 V, +10 dBm	dBc	—	-94	—
	900 MHz, 2.6 V, +20 dBm			-75	
	900 MHz, 3 V, +20 dBm			-80	
	2.45 GHz, 2.6 V, +10 dBm			-86	
	2.45 GHz, 2.6 V, +20 dBm			-70	
	2.45 GHz, 3 V, +20 dBm			-99	
3rd Harmonic	900 MHz, 2.6 V, +10 dBm	dBc	—	-102	—
	900 MHz, 2.6 V, +20 dBm			-80	
	900 MHz, 3 V, +20 dBm			-100	
	2.45 GHz, 2.6 V, +10 dBm			-94	
	2.45 GHz, 2.6 V, +20 dBm			-70	
	2.45 GHz, 3 V, +20 dBm			-78	
Trise, Tfall	10% to 90% RF	ns	—	25	—
	90% to 10% RF			14	
Ton, Toff	50% control to 90% RF	ns	—	30	—
	50% control to 10% RF			26	
Gate Lag	50% control to 100% RF	µs	—	4	—
Control Current	$ V_C  = 2.6\text{V}$	µA	—	4	20
Thermal Resistance	Junction to case	°C/W	—	96	—

7. For positive control voltage, external DC blocking capacitors are required on all RF ports.

8. Insertion loss can be optimized by varying the DC blocking capacitor value, e.g. 100 pF for 100 - 500 MHz, 39 pF for 2.45 GHz.

9. Specifications apply with no connection to pin 2 ( $V_P$ ).

2

## Typical Performance Curves

**Insertion Loss**

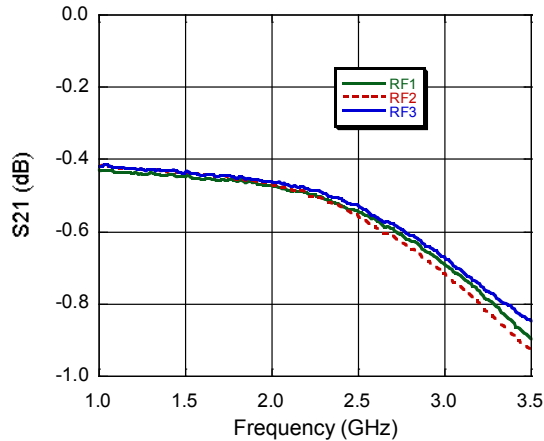

**Isolation**

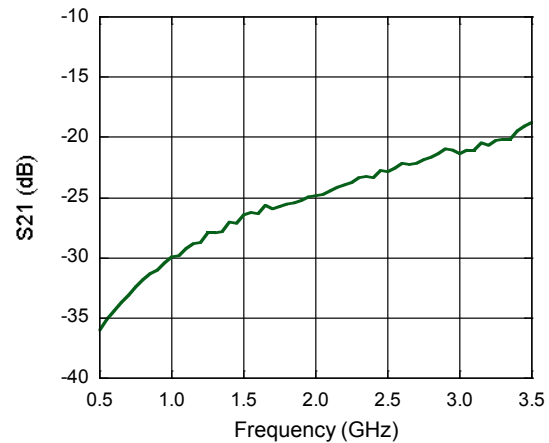

**Return Loss**

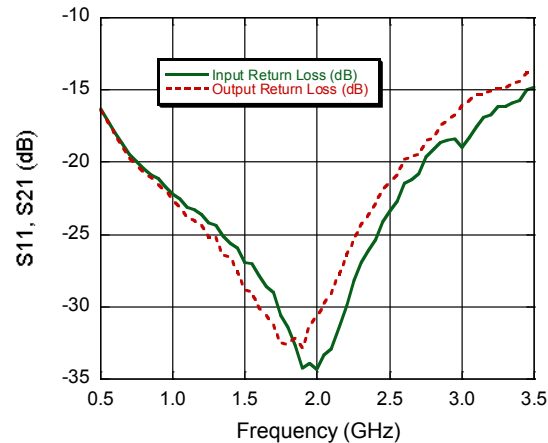

## Handling Procedures

Please observe the following precautions to avoid damage:

## Static Sensitivity

Gallium Arsenide Integrated Circuits are sensitive to electrostatic discharge (ESD) and can be damaged by static electricity. Proper ESD control techniques should be used when handling these devices.

## Truth Table <sup>10,11,12</sup>

V1	V2	V3	RFC - RF1	RFC - RF2	RFC - RF3
1	0	0	On	Off	Off
0	1	0	Off	On	Off
0	0	1	Off	Off	On

10. 0 = 0 V  $\pm$  0.2 V, 1 = 1.8 V to +5 V, minimum  $V_{HI}-V_{LO}$  = 1.8 V, maximum  $V_{HI}-V_{LO}$  = 8.5 V.
11. For use at low voltage, M/A-COM recommends connecting pin 2 to a voltage equal to the most positive control voltage.
12. Negative control voltage may be used. The '1' in the table would be the most positive (0 V) and the '0' would be the most negative (-3 V for example).

## GaAs SP3T Switch DC - 3.5 GHz

Rev. V2

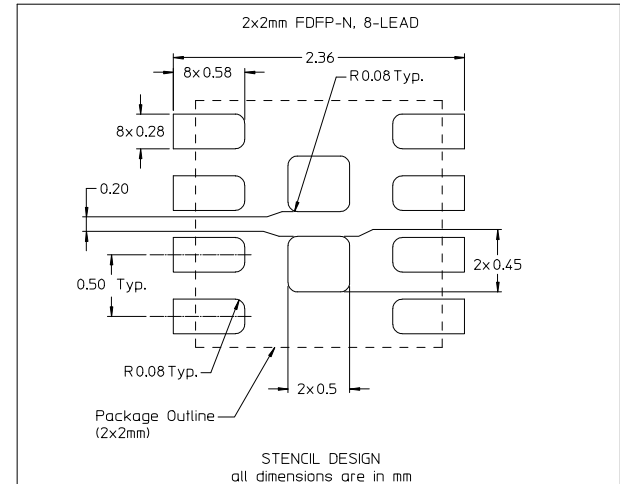
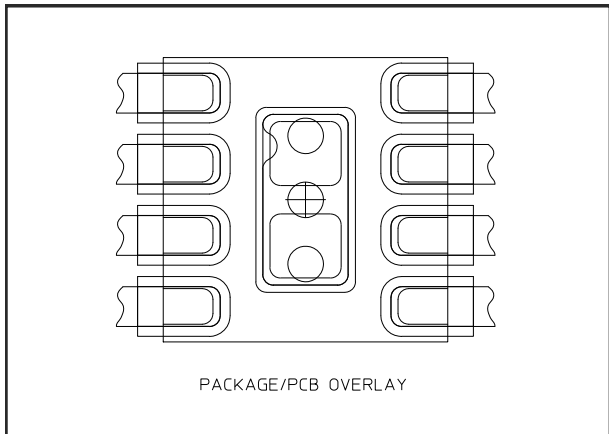
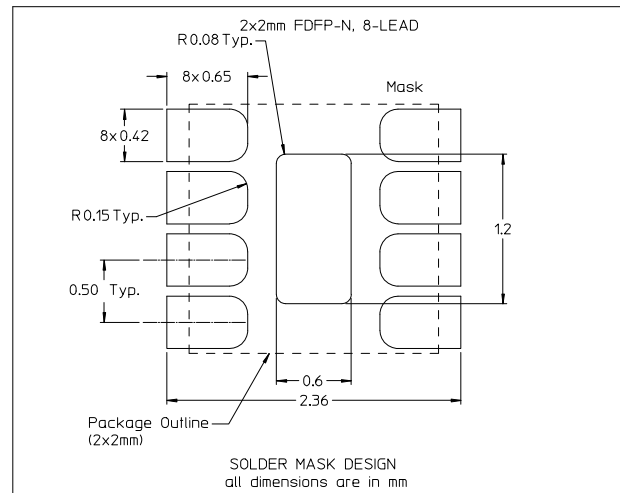
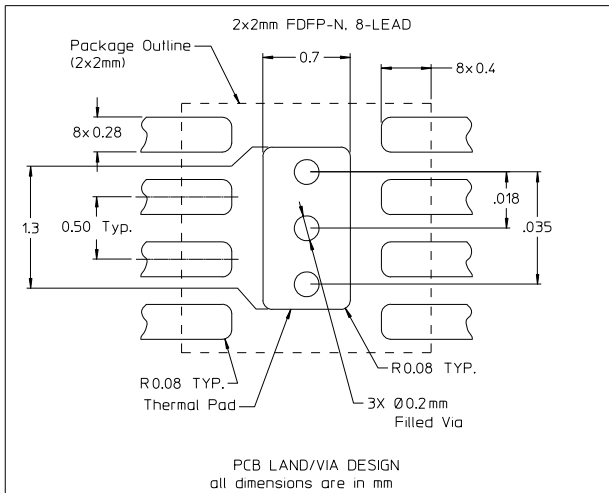

### Lead Free 2 mm 8-lead PDFN<sup>†</sup>

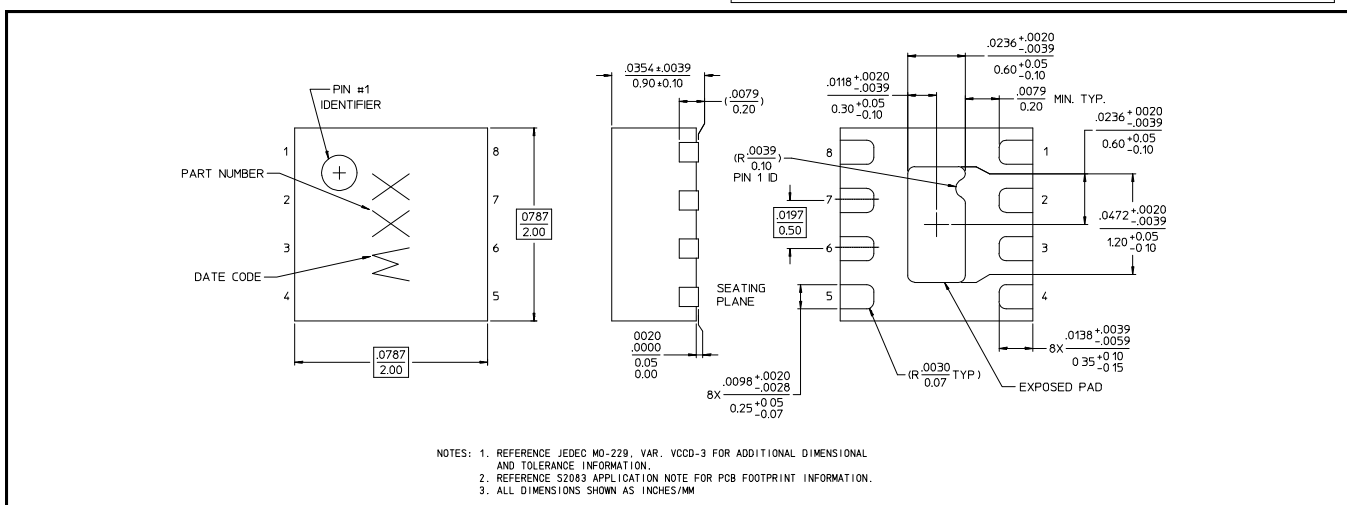

<sup>†</sup> Reference Application Note S2083 for lead-free solder reflow recommendations.  
Meets JEDEC moisture sensitivity level 1 requirements.  
Plating is 100% matte tin over copper.

M/A-COM Technology Solutions Inc. All rights reserved.

Information in this document is provided in connection with M/A-COM Technology Solutions Inc ("MACOM") products. These materials are provided by MACOM as a service to its customers and may be used for informational purposes only. Except as provided in MACOM's Terms and Conditions of Sale for such products or in any separate agreement related to this document, MACOM assumes no liability whatsoever. MACOM assumes no responsibility for errors or omissions in these materials. MACOM may make changes to specifications and product descriptions at any time, without notice. MACOM makes no commitment to update the information and shall have no responsibility whatsoever for conflicts or incompatibilities arising from future changes to its specifications and product descriptions. No license, express or implied, by estoppel or otherwise, to any intellectual property rights is granted by this document.

THESE MATERIALS ARE PROVIDED "AS IS" WITHOUT WARRANTY OF ANY KIND, EITHER EXPRESS OR IMPLIED, RELATING TO SALE AND/OR USE OF MACOM PRODUCTS INCLUDING LIABILITY OR WARRANTIES RELATING TO FITNESS FOR A PARTICULAR PURPOSE, CONSEQUENTIAL OR INCIDENTAL DAMAGES, MERCHANTABILITY, OR INFRINGEMENT OF ANY PATENT, COPYRIGHT OR OTHER INTELLECTUAL PROPERTY RIGHT. MACOM FURTHER DOES NOT WARRANT THE ACCURACY OR COMPLETENESS OF THE INFORMATION, TEXT, GRAPHICS OR OTHER ITEMS CONTAINED WITHIN THESE MATERIALS. MACOM SHALL NOT BE LIABLE FOR ANY SPECIAL, INDIRECT, INCIDENTAL, OR CONSEQUENTIAL DAMAGES, INCLUDING WITHOUT LIMITATION, LOST REVENUES OR LOST PROFITS, WHICH MAY RESULT FROM THE USE OF THESE MATERIALS.

MACOM products are not intended for use in medical, lifesaving or life sustaining applications. MACOM customers using or selling MACOM products for use in such applications do so at their own risk and agree to fully indemnify MACOM for any damages resulting from such improper use or sale.