

CZRMF4747A-HF

Zener Voltage: 20 Volts

DC Power: 1 Watts

RoHS Device

Halogen Free

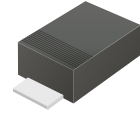

Features

- Glass passivated chip.
- Low leakage current.
- Built-in strain relief.
- Low inductance.
- High peak reverse power dissipation.
- For use in stabilizing and clipping with high power rating.

Mechanical data

- Case: Molded plastic.
- Epoxy: UL 94V-0 rate flame retardant.
- Lead: Solderable per MIL-STD-750, method 2026.
- Polarity: Color band denotes cathode end except bipolar.
- Mounting position: Any.
- Weight: 0.062 grams (approx.).

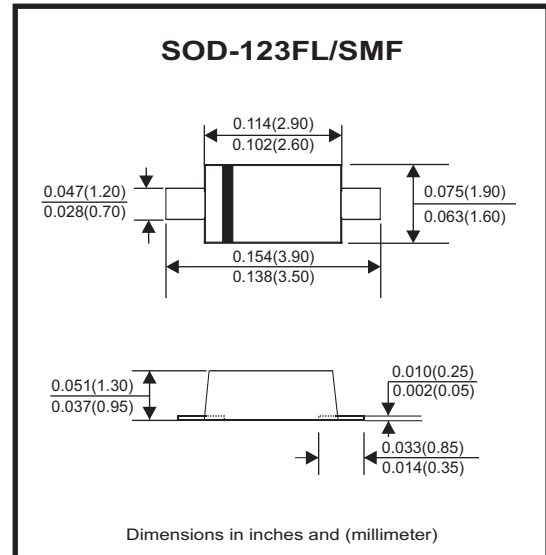

Circuit diagram



Maximum Rating (at $T_A=25^\circ\text{C}$ unless otherwise specified)

Parameter	Conditions	Symbol	Value	Unit
DC power dissipation	$T_L=50^\circ\text{C}$ (note.1)	P_D	1	W
Forward voltage	$I_F=200\text{mA}$	V_F	1.2	V
Thermal resistance	Junction to ambient air (note.2)	$R_{\theta JA}$	170	K/W
Junction temperature range		T_J	-55 to +175	$^\circ\text{C}$
Storage temperature range		T_{STG}	-55 to +175	$^\circ\text{C}$

Notes: 1. T_L = Lead temperature at 3/8" (9.5mm) from body.

2. Valid provided that leads are kept at ambient temperature at a distance of 10mm from case.

Electrical Characteristics (at $T_A=25^\circ\text{C}$ unless otherwise specified)

Part Number	Nominal Zener Voltage		Maximum Zener Impedance			Maximum Reverse Leakage Current		Maximum DC Zener Current	Maximum Surge Current	Device marking code
	$V_Z@I_{ZT}$	I_{ZT}	$Z_{ZT}@I_{ZT}$	$Z_{ZK}@I_{ZK}$	I_{ZK}	$I_R@V_R$		I_{ZM}	I_{RM}	
	V	mA	Ω	Ω	mA	μA	V	mA	mApk	
CZRMF4747A-HF	20	12.5	22	750	0.25	0.10	15.2	45	225	47A

Notes: 1. The type number listed have a standard tolerance on the nominal zener voltage of $\pm 5\%$

2. The reverse surge current is a non-repetitive, 8.3ms pulse width square wave or equivalent sine wave superimposed on I_{ZT} per JEDEC method.

RATING AND CHARACTERISTIC CURVES (CZRMF4747A-HF)

Fig.1 - Power Temperature Derating Curve

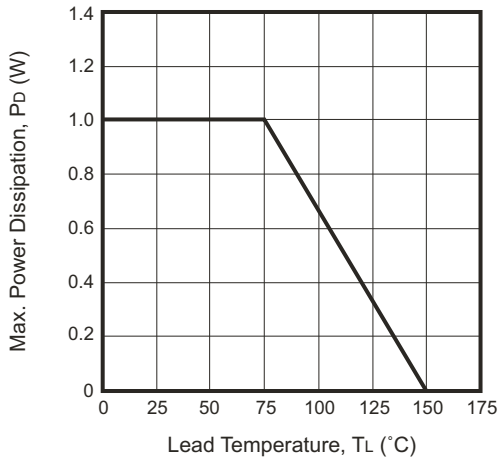

Fig.2 - Temperature Coefficients v.s. Zener Voltage

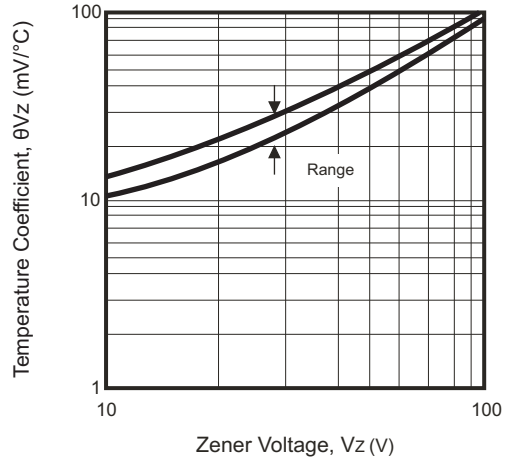

Fig.3 - Typical Thermal Resistance v.s. Lead Length

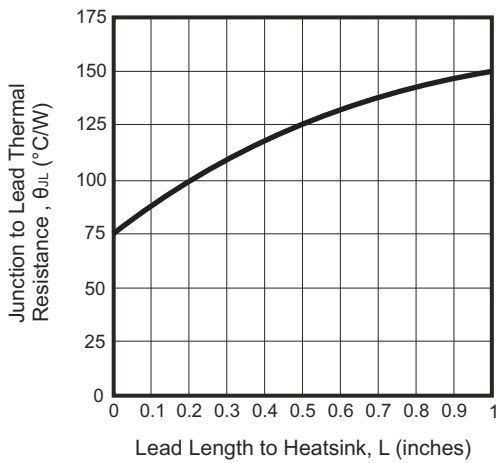
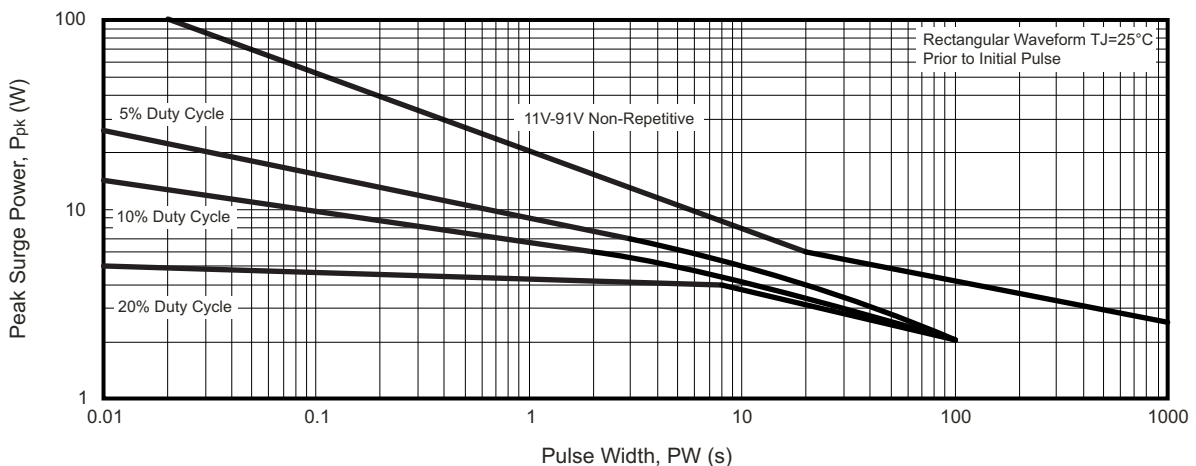
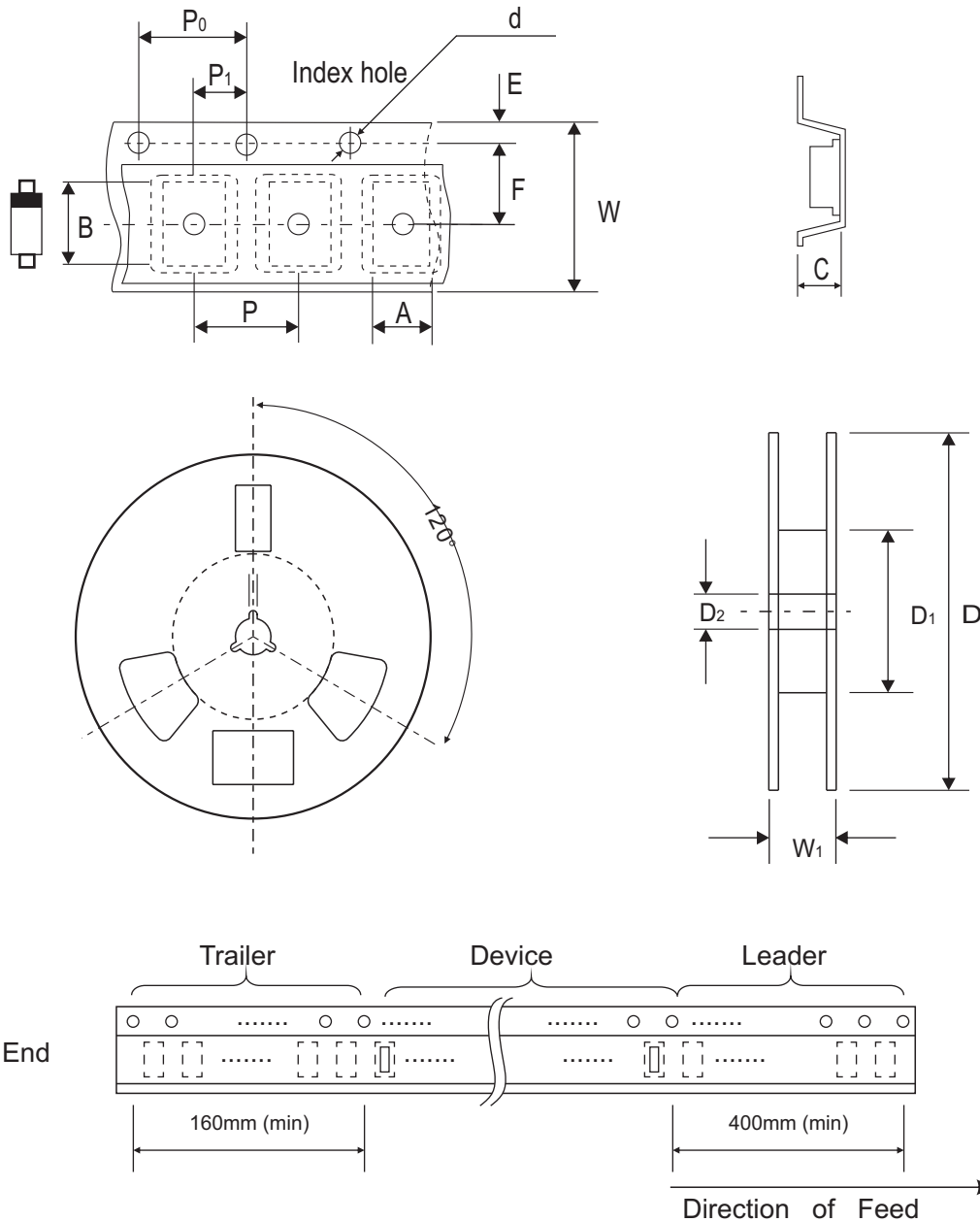

Fig.4 - Maximum Surge Power



Reel Taping Specification



SOD-123FL/SMF	SYMBOL	A	B	C	d	D	D1	D2
	(mm)	See Note 1			1.55 ± 0.05	178.00 ± 1.00	50.00 Min.	13.00 ± 0.20
	(inch)	See Note 1			0.061 ± 0.002	7.008 ± 0.039	1.969 Min.	0.512 ± 0.008

SOD-123FL/SMF	SYMBOL	E	F	P	P0	P1	W	W1
	(mm)	1.75 ± 0.10	3.50 ± 0.10	4.00 ± 0.10	4.00 ± 0.10	2.00 ± 0.05	8.00 ± 0.10	11.40 Max.
	(inch)	0.069 ± 0.004	0.138 ± 0.004	0.157 ± 0.004	0.157 ± 0.004	0.079 ± 0.002	0.315 ± 0.004	0.449 Max.

Note: 1. A, B, and C the clearance between the component and the cavity must be within 0.5mm max. for 8mm tape and 12mm tape, 1.0mm max. for 16mm tape and 24mm tape.

Marking Code

Part Number	Marking Code
CZRMF4747A-HF	47A



Suggested PAD Layout

SIZE	SOD-123FL/SMF	
	(mm)	(inch)
A	2.90	0.114
B	1.30	0.051
C	1.40	0.055
D	4.20	0.165
E	1.60	0.063

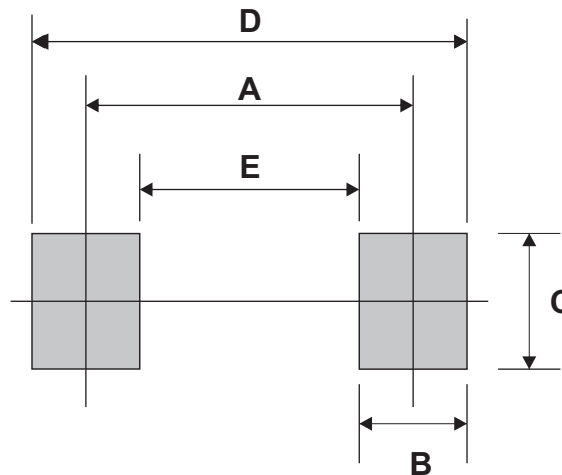

Standard Packaging

Case Type	REEL PACK	
	REEL (pcs)	Reel Size (inch)
SOD-123FL/SMF	3,000	7