

Abdeckung vorverrastet
cover loose mounted

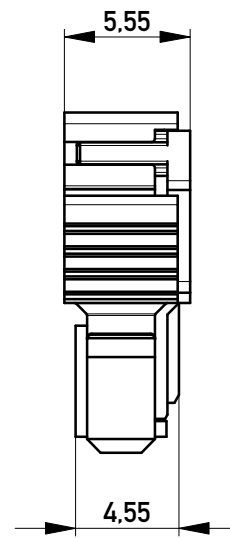

Abdeckung verpresst
cover pressed on

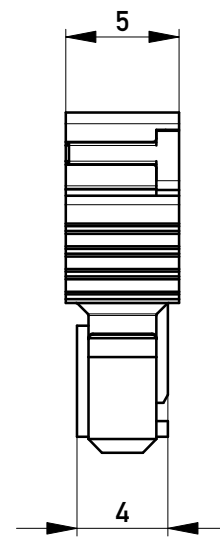

Verpackt in Tray - tray packaging
Verpackungseinheit 77 Stück - packaging unit 77

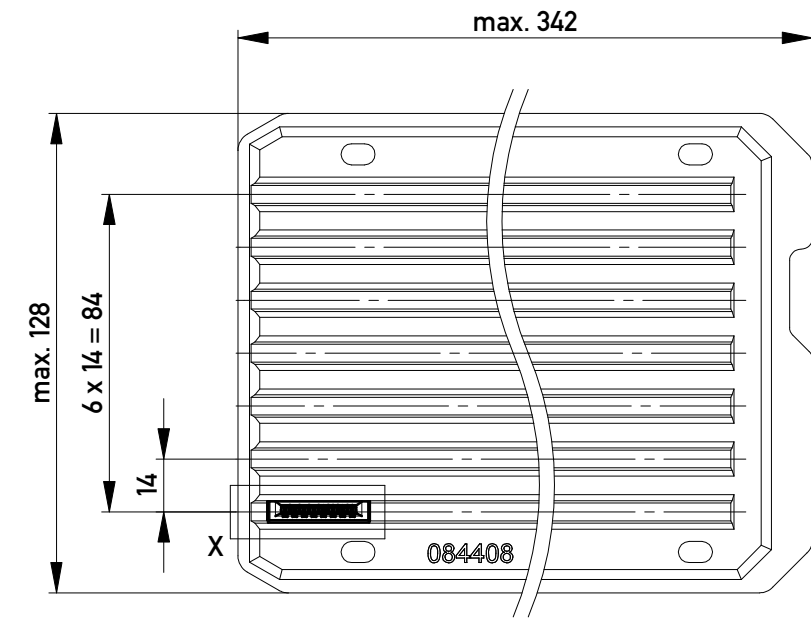

Einzelheit X
detail X

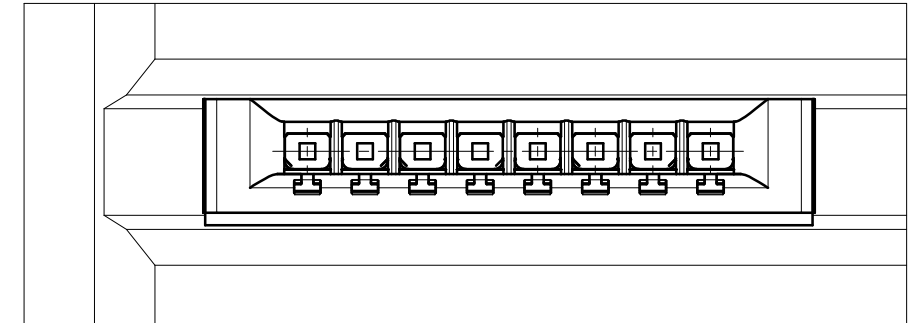

Copyright by ERNI GmbH
Proprietary notice pursuant to ISO 16016 to be observed.

Information: Codierung schwarz - coding black		Tolerances		Scale	3:1
All rights reserved. Only for Information. To ensure that this is the latest version of this drawing, please contact one of the ERNI companies before using.		Subject to modification without prior notice. Drawing will not be updated.		Designation F 2.54 SRC-A, 8-polig BA 2	
c		14.05.2014		105102070001	
Index		Date		Class SRCBUG	
		www.ERNI.com		K A3	