



Inductors for Standard Circuits

Multilayer Ferrite

MLF Series

MLF2012 Type

MLF2012

2012 [0805 inch]*

* Dimensions Code JIS[EIA]

REMINDERS FOR USING THESE PRODUCTS

Before using these products, be sure to request the delivery specifications.

SAFETY REMINDERS

Please pay sufficient attention to the warnings for safe designing when using these products.

REMINDERS

- The storage period is less than 12 months. Be sure to follow the storage conditions (Temperature: 5 to 40°C, Humidity: 10 to 75% RH or less).
If the storage period elapses, the soldering of the terminal electrodes may deteriorate.
- Do not use or store in locations where there are conditions such as gas corrosion (salt, acid, alkali, etc.).
- Before soldering, be sure to preheat components.
The preheating temperature should be set so that the temperature difference between the solder temperature and chip temperature does not exceed 150°C.
- Soldering corrections after mounting should be within the range of the conditions determined in the specifications.
If overheated, a short circuit, performance deterioration, or lifespan shortening may occur.
- When embedding a printed circuit board where a chip is mounted to a set, be sure that residual stress is not given to the chip due to the overall distortion of the printed circuit board and partial distortion such as at screw tightening portions.
- Self heating (temperature increase) occurs when the power is turned ON, so the tolerance should be sufficient for the set thermal design.
- Carefully lay out the coil for the circuit board design of the non-magnetic shield type.
A malfunction may occur due to magnetic interference.
- Use a wrist band to discharge static electricity in your body through the grounding wire.
- Do not expose the products to magnets or magnetic fields.
- Do not use for a purpose outside of the contents regulated in the delivery specifications.
- The products listed on this catalog are intended for use in general electronic equipment (AV equipment, telecommunications equipment, home appliances, amusement equipment, computer equipment, personal equipment, office equipment, measurement equipment, industrial robots) under a normal operation and use condition.
The products are not designed or warranted to meet the requirements of the applications listed below, whose performance and/or quality require a more stringent level of safety or reliability, or whose failure, malfunction or trouble could cause serious damage to society, person or property.
If you intend to use the products in the applications listed below or if you have special requirements exceeding the range or conditions set forth in the each catalog, please contact us.

- (1) Aerospace/Aviation equipment
- (2) Transportation equipment (cars, electric trains, ships, etc.)
- (3) Medical equipment
- (4) Power-generation control equipment
- (5) Atomic energy-related equipment
- (6) Seabed equipment
- (7) Transportation control equipment

- (8) Public information-processing equipment
- (9) Military equipment
- (10) Electric heating apparatus, burning equipment
- (11) Disaster prevention/crime prevention equipment
- (12) Safety equipment
- (13) Other applications that are not considered general-purpose applications

When designing your equipment even for general-purpose applications, you are kindly requested to take into consideration securing protection circuit/device or providing backup circuits in your equipment.

Inductors for Standard Circuits

Multilayer Ferrite

Product compatible with RoHS directive
Halogen-free
Compatible with lead-free solders

Overview of MLF2012 Type

FEATURES

- The lineup includes a wide inductance range.
- Highly reliable monolithic structure with multilayer integration.

APPLICATION

Smart phones, tablet terminals, tuners, LCD-TVs, PDP-TVs, audio equipment, computers, signal processing for modules etc.

PART NUMBER CONSTRUCTION

| MLF | 2012 | D | 47N | △ | T | 000 | | | |
|-------------|-----------------------|---------------|-----------------|-----------------|--------|----------------------|-----------------|---------------|-----|
| Series name | L×W×H Dimensions (mm) | | characteristics | Inductance (μH) | | Inductance tolerance | Packaging style | Internal code | |
| MLF2012 | 2012 | 2.0×1.25×0.85 | A | 10N | 0.010 | J | T | Taping | 000 |
| | | 2.0×1.25×1.25 | C | | (10nH) | K | | | |
| | | D | R10 | 0.1 | M | | | | |
| | | E | 1R0 | 1 | | | | | |
| | | K | 100 | 10 | | | | | |

OPERATING TEMPERATURE RANGE, PACKAGE QUANTITY, PRODUCT WEIGHT

| Type | Temperature range* | | Package quantity (pieces/reel) | Individual weight (mg) |
|---------|----------------------------|----------------------------|-----------------------------------|---------------------------|
| | Operating temperature (°C) | Storage temperature** (°C) | | |
| MLF2012 | t=0.85 | -55 to +125 | 4,000 | 10 |
| | t=1.25 | | | |

* In case the product's inductance is 15μH or higher, both Operating and Storage temperature ranges are -40 to +85°C.

** The Storage temperature range is for after the circuit board is mounted.

- RoHS Directive Compliant Product: See the following for more details related to RoHS Directive compliant products. <http://product.tdk.com/en/environment/rohs/>
- Halogen-free: Indicates that Cl content is less than 900ppm, Br content is less than 900ppm, and that the total Cl and Br content is less than 1500ppm.

 Please be sure to request delivery specifications that provide further details on the features and specifications of the products for proper and safe use. Please note that the contents may change without any prior notice due to reasons such as upgrading.

MLF2012 Type

RECOMMENDED REFLOW PROFILE

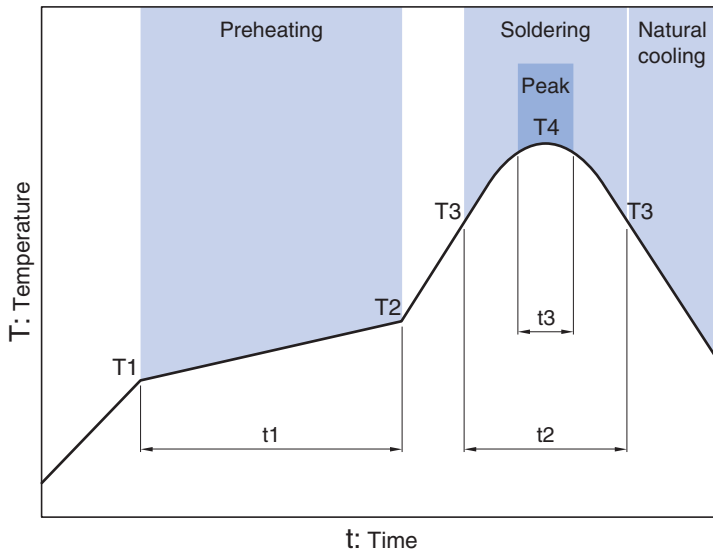

| Preheating | | | Soldering | | Peak | |
|------------|-------|------------|-----------|-----------|--------------|----------|
| Temp. | Temp. | Time | Temp. | Time | Temp. | Time |
| T1 | T2 | t1 | T3 | t2 | T4 | t3 |
| 150°C | 180°C | 60 to 120s | 230°C | 30 to 60s | 250 to 260°C | 10s max. |

MLF2012 Type

SHAPE & DIMENSIONS

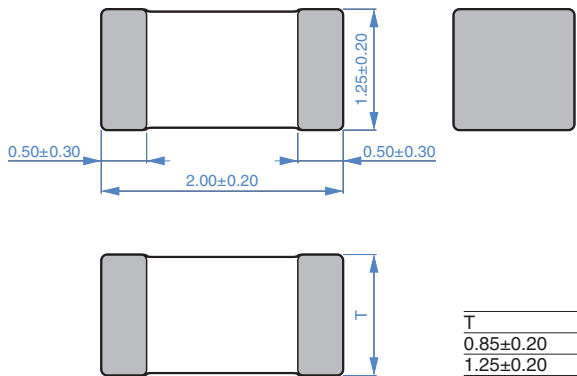

Dimensions in mm



RECOMMENDED LAND PATTERN

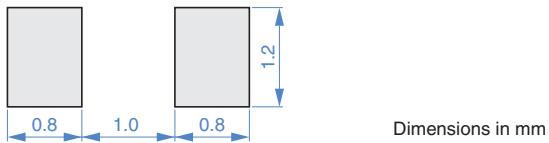

Dimensions in mm

MLF2012 Type

ELECTRICAL CHARACTERISTICS

CHARACTERISTICS SPECIFICATION TABLE

| L (μ H) | Q Tolerance | Q | | L, Q measuring conditions | | Self-resonant frequency | | DC resistance | | Rated current (mA) max. | Thickness T (mm) | Part No.* |
|-----------------|-----------------------------|------|------|---------------------------|-----------------|-------------------------|---------------|----------------------|----------------------|-------------------------------|------------------------|------------------------------|
| | | min. | typ. | Frequency (MHz) | Current (mA) | (MHz) min. | (MHz) typ. | (Ω) max. | (Ω) typ. | | | |
| 0.047 | $\pm 20\%$ | 15 | 25 | 50 | 1.0 | 550 | 700 | 0.10 | 0.05 | 300 | 0.85 | MLF2012D47N \triangle T000 |
| 0.068 | $\pm 20\%$ | 15 | 25 | 50 | 1.0 | 500 | 600 | 0.15 | 0.08 | 300 | 0.85 | MLF2012D68N \triangle T000 |
| 0.082 | $\pm 20\%$ | 15 | 25 | 50 | 1.0 | 450 | 550 | 0.15 | 0.08 | 300 | 0.85 | MLF2012D82N \triangle T000 |
| 0.10 | $\pm 5\% \pm 10\% \pm 20\%$ | 20 | 30 | 25 | 1.0 | 400 | 500 | 0.15 | 0.10 | 300 | 0.85 | MLF2012DR10 \triangle T000 |
| 0.12 | $\pm 5\% \pm 10\% \pm 20\%$ | 20 | 30 | 25 | 1.0 | 360 | 450 | 0.20 | 0.12 | 300 | 0.85 | MLF2012DR12 \triangle T000 |
| 0.15 | $\pm 5\% \pm 10\% \pm 20\%$ | 20 | 30 | 25 | 1.0 | 320 | 410 | 0.20 | 0.13 | 300 | 0.85 | MLF2012DR15 \triangle T000 |
| 0.18 | $\pm 5\% \pm 10\% \pm 20\%$ | 20 | 30 | 25 | 1.0 | 280 | 370 | 0.25 | 0.15 | 300 | 0.85 | MLF2012DR18 \triangle T000 |
| 0.22 | $\pm 5\% \pm 10\% \pm 20\%$ | 20 | 30 | 25 | 1.0 | 250 | 330 | 0.30 | 0.16 | 250 | 0.85 | MLF2012DR22 \triangle T000 |
| 0.27 | $\pm 5\% \pm 10\% \pm 20\%$ | 20 | 30 | 25 | 1.0 | 220 | 300 | 0.35 | 0.18 | 250 | 0.85 | MLF2012DR27 \triangle T000 |
| 0.33 | $\pm 5\% \pm 10\% \pm 20\%$ | 20 | 30 | 25 | 1.0 | 200 | 270 | 0.40 | 0.23 | 250 | 0.85 | MLF2012DR33 \triangle T000 |
| 0.39 | $\pm 5\% \pm 10\% \pm 20\%$ | 25 | 35 | 25 | 1.0 | 180 | 250 | 0.45 | 0.25 | 200 | 0.85 | MLF2012DR39 \triangle T000 |
| 0.47 | $\pm 5\% \pm 10\% \pm 20\%$ | 25 | 35 | 25 | 1.0 | 160 | 230 | 0.50 | 0.25 | 200 | 1.25 | MLF2012DR47 \triangle T000 |
| 0.56 | $\pm 5\% \pm 10\% \pm 20\%$ | 25 | 35 | 25 | 1.0 | 150 | 210 | 0.55 | 0.30 | 150 | 1.25 | MLF2012DR56 \triangle T000 |
| 0.68 | $\pm 5\% \pm 10\% \pm 20\%$ | 25 | 35 | 25 | 1.0 | 140 | 190 | 0.60 | 0.35 | 150 | 1.25 | MLF2012DR68 \triangle T000 |
| 0.82 | $\pm 5\% \pm 10\% \pm 20\%$ | 25 | 35 | 25 | 1.0 | 130 | 170 | 0.65 | 0.40 | 150 | 1.25 | MLF2012DR82 \triangle T000 |
| 1.0 | $\pm 5\% \pm 10\% \pm 20\%$ | 45 | 55 | 10 | 1.0 | 120 | 160 | 0.30 | 0.15 | 80 | 0.85 | MLF2012A1R0 \triangle T000 |
| 1.2 | $\pm 5\% \pm 10\% \pm 20\%$ | 45 | 55 | 10 | 1.0 | 110 | 150 | 0.35 | 0.15 | 80 | 0.85 | MLF2012A1R2 \triangle T000 |
| 1.5 | $\pm 5\% \pm 10\% \pm 20\%$ | 45 | 60 | 10 | 1.0 | 100 | 140 | 0.40 | 0.18 | 80 | 0.85 | MLF2012A1R5 \triangle T000 |
| 1.8 | $\pm 5\% \pm 10\% \pm 20\%$ | 45 | 60 | 10 | 1.0 | 90 | 130 | 0.45 | 0.20 | 80 | 0.85 | MLF2012A1R8 \triangle T000 |
| 2.2 | $\pm 5\% \pm 10\% \pm 20\%$ | 45 | 60 | 10 | 1.0 | 80 | 120 | 0.50 | 0.22 | 50 | 0.85 | MLF2012A2R2 \triangle T000 |
| 2.7 | $\pm 5\% \pm 10\% \pm 20\%$ | 45 | 70 | 10 | 1.0 | 70 | 100 | 0.55 | 0.25 | 50 | 1.25 | MLF2012A2R7 \triangle T000 |
| 3.3 | $\pm 5\% \pm 10\% \pm 20\%$ | 45 | 70 | 10 | 1.0 | 60 | 90 | 0.60 | 0.28 | 50 | 1.25 | MLF2012A3R3 \triangle T000 |
| 3.9 | $\pm 5\% \pm 10\% \pm 20\%$ | 45 | 70 | 10 | 1.0 | 55 | 80 | 0.65 | 0.30 | 30 | 1.25 | MLF2012A3R9 \triangle T000 |
| 4.7 | $\pm 5\% \pm 10\% \pm 20\%$ | 45 | 70 | 10 | 1.0 | 50 | 70 | 0.70 | 0.35 | 30 | 1.25 | MLF2012A4R7 \triangle T000 |
| 5.6 | $\pm 5\% \pm 10\% \pm 20\%$ | 50 | 75 | 4 | 0.1 | 45 | 65 | 0.60 | 0.30 | 15 | 1.25 | MLF2012E5R6 \triangle T000 |
| 6.8 | $\pm 5\% \pm 10\% \pm 20\%$ | 50 | 75 | 4 | 0.1 | 40 | 60 | 0.65 | 0.32 | 15 | 1.25 | MLF2012E6R8 \triangle T000 |
| 8.2 | $\pm 5\% \pm 10\% \pm 20\%$ | 50 | 75 | 4 | 0.1 | 35 | 55 | 0.70 | 0.35 | 15 | 1.25 | MLF2012E8R2 \triangle T000 |
| 10 | $\pm 5\% \pm 10\% \pm 20\%$ | 50 | 75 | 2 | 0.1 | 30 | 50 | 0.80 | 0.40 | 15 | 1.25 | MLF2012E100 \triangle T000 |
| 12 | $\pm 5\% \pm 10\% \pm 20\%$ | 50 | 75 | 2 | 0.1 | 25 | 45 | 0.90 | 0.50 | 15 | 1.25 | MLF2012E120 \triangle T000 |
| 15 | $\pm 10\% \pm 20\%$ | 30 | 45 | 1 | 0.1 | 22 | 40 | 0.70 | 0.35 | 5 | 1.25 | MLF2012C150 \triangle T000 |
| 18 | $\pm 10\% \pm 20\%$ | 30 | 45 | 1 | 0.1 | 20 | 38 | 0.80 | 0.38 | 5 | 1.25 | MLF2012C180 \triangle T000 |
| 22 | $\pm 10\% \pm 20\%$ | 30 | 45 | 1 | 0.1 | 18 | 35 | 0.90 | 0.45 | 5 | 1.25 | MLF2012C220 \triangle T000 |
| 27 | $\pm 10\% \pm 20\%$ | 30 | 45 | 1 | 0.1 | 17 | 33 | 1.00 | 0.50 | 5 | 1.25 | MLF2012C270 \triangle T000 |
| 33 | $\pm 10\% \pm 20\%$ | 30 | 45 | 0.4 | 0.1 | 15 | 28 | 1.10 | 0.55 | 5 | 1.25 | MLF2012C330 \triangle T000 |
| 39 | $\pm 10\% \pm 20\%$ | 35 | 55 | 2 | 0.1 | 13 | 23 | 2.40 | 1.30 | 4 | 1.25 | MLF2012K390 \triangle T000 |
| 47 | $\pm 10\% \pm 20\%$ | 35 | 55 | 2 | 0.1 | 11 | 20 | 2.70 | 1.60 | 4 | 1.25 | MLF2012K470 \triangle T000 |
| 56 | $\pm 10\% \pm 20\%$ | 35 | 55 | 2 | 0.1 | 10 | 18 | 2.80 | 1.80 | 4 | 1.25 | MLF2012K560 \triangle T000 |
| 68 | $\pm 10\% \pm 20\%$ | 25 | 45 | 1 | 0.1 | 9 | 16 | 2.90 | 2.00 | 2 | 1.25 | MLF2012C680 \triangle T000 |
| 82 | $\pm 10\% \pm 20\%$ | 25 | 45 | 1 | 0.1 | 8 | 14 | 3.00 | 2.40 | 2 | 1.25 | MLF2012C820 \triangle T000 |
| 100 | $\pm 10\% \pm 20\%$ | 25 | 45 | 1 | 0.1 | 7 | 12 | 3.10 | 2.50 | 2 | 1.25 | MLF2012C101 \triangle T000 |

* The " \triangle " of the Part Number contains the inductance tolerance code, J ($\pm 5\%$), K ($\pm 10\%$), or M ($\pm 20\%$).

○ Measurement equipment

| Measurement item | Product No. | Manufacturer |
|-------------------------|--------------|----------------------|
| L, Q | 4294A+16034G | Agilent Technologies |
| Self-resonant frequency | E4991A | Agilent Technologies |
| DC resistance | Type-7561 | Yokogawa |

* Equivalent measurement equipment may be used.

 Please be sure to request delivery specifications that provide further details on the features and specifications of the products for proper and safe use. Please note that the contents may change without any prior notice due to reasons such as upgrading.

MLF2012 Type

ELECTRICAL CHARACTERISTICS

L FREQUENCY CHARACTERISTICS GRAPH

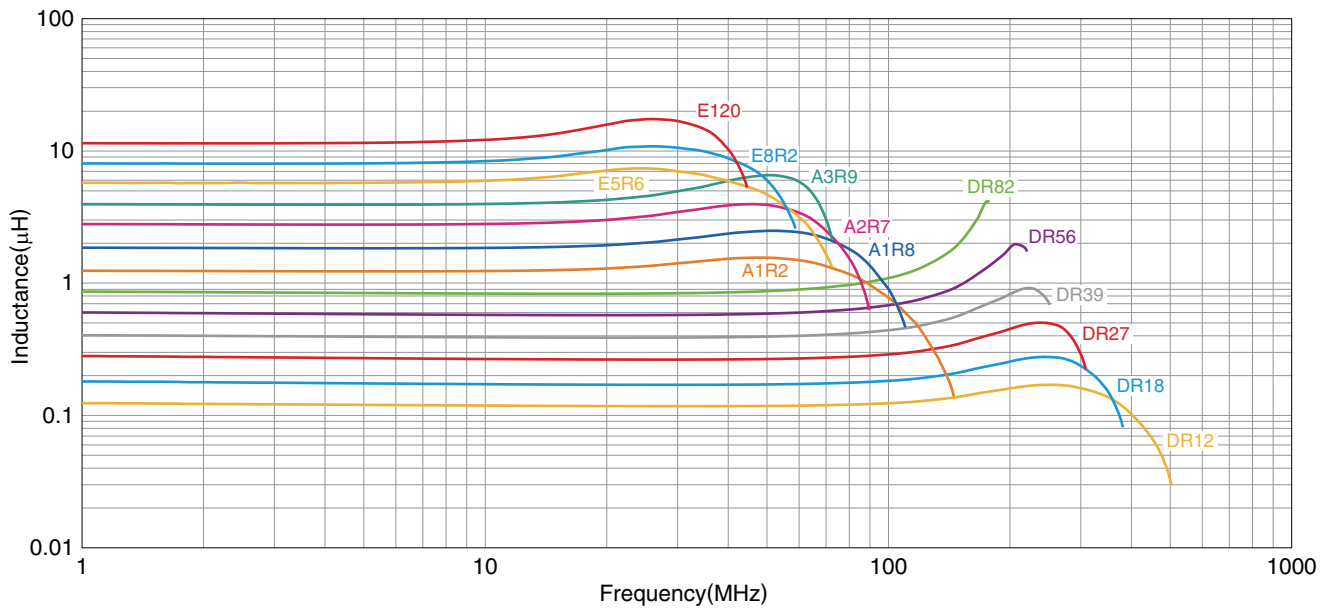
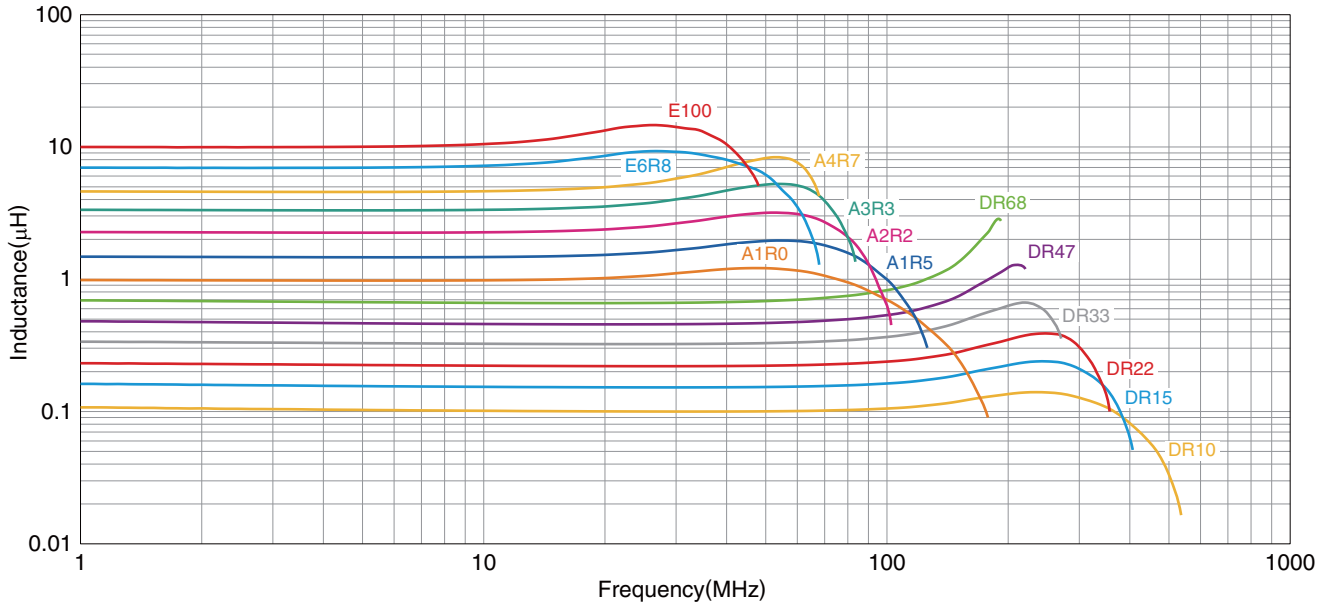

○ Measurement equipment

| Product No. | Manufacturer |
|---------------|----------------------|
| E4991A+16192A | Agilent Technologies |

* Equivalent measurement equipment may be used.

 Please be sure to request delivery specifications that provide further details on the features and specifications of the products for proper and safe use. Please note that the contents may change without any prior notice due to reasons such as upgrading.

MLF2012 Type

ELECTRICAL CHARACTERISTICS

L FREQUENCY CHARACTERISTICS GRAPH

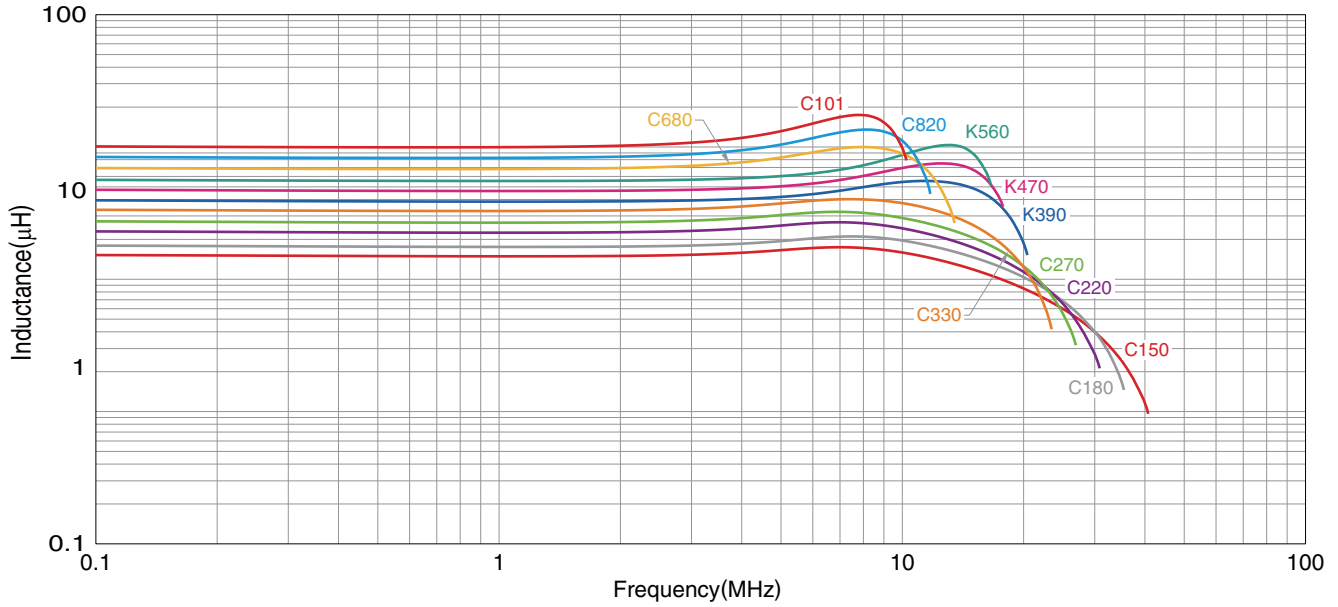

○ Measurement equipment

| Product No. | Manufacturer |
|--------------|----------------------|
| 4294A+16034G | Agilent Technologies |

* Equivalent measurement equipment may be used.

 Please be sure to request delivery specifications that provide further details on the features and specifications of the products for proper and safe use. Please note that the contents may change without any prior notice due to reasons such as upgrading.

MLF2012 Type

ELECTRICAL CHARACTERISTICS

Q FREQUENCY CHARACTERISTICS GRAPH

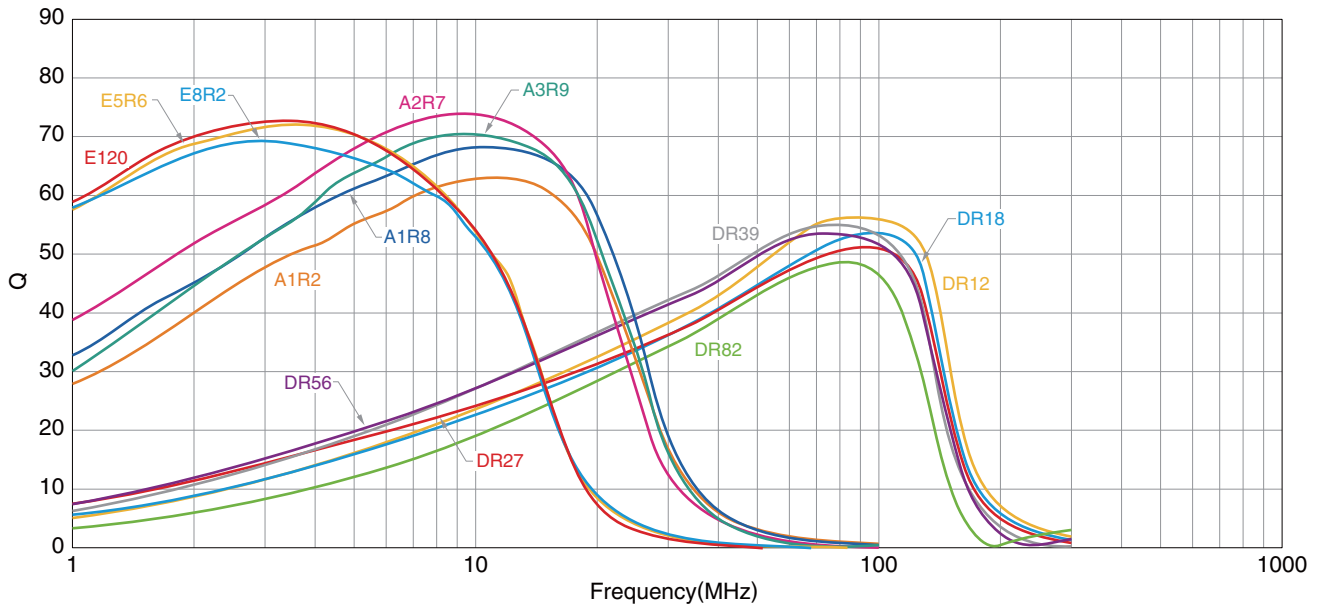
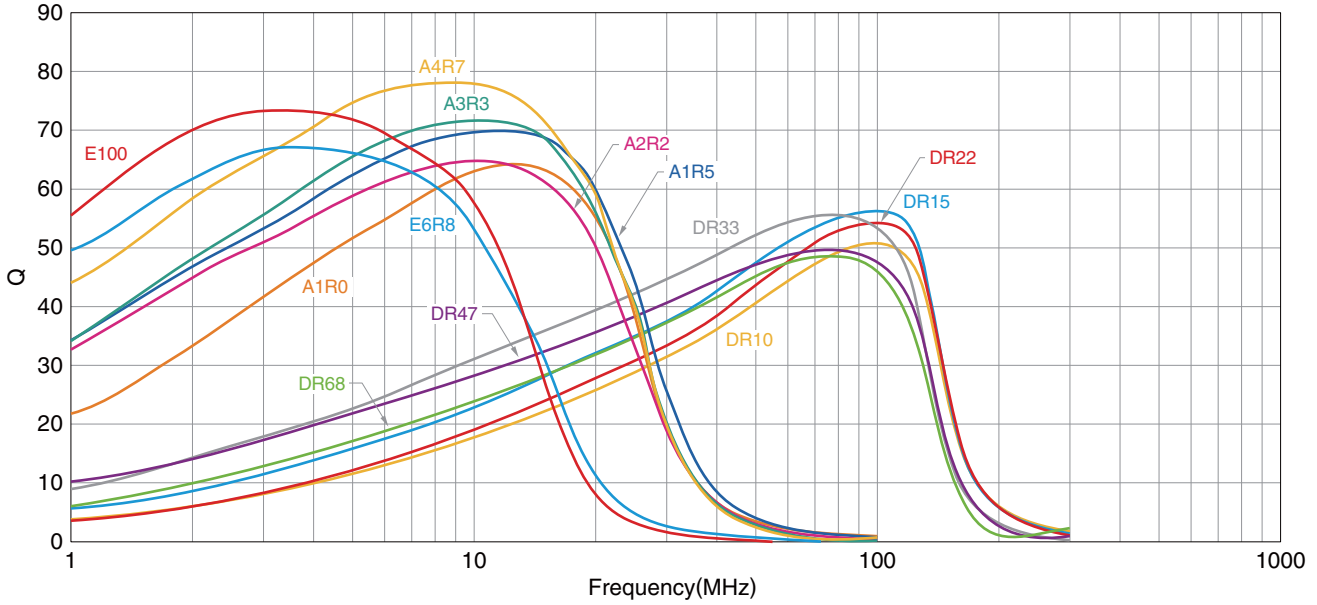

○ Measurement equipment

| Product No. | Manufacturer |
|---------------|----------------------|
| E4991A+16192A | Agilent Technologies |

* Equivalent measurement equipment may be used.

 Please be sure to request delivery specifications that provide further details on the features and specifications of the products for proper and safe use. Please note that the contents may change without any prior notice due to reasons such as upgrading.

MLF2012 Type

Q FREQUENCY CHARACTERISTICS GRAPH

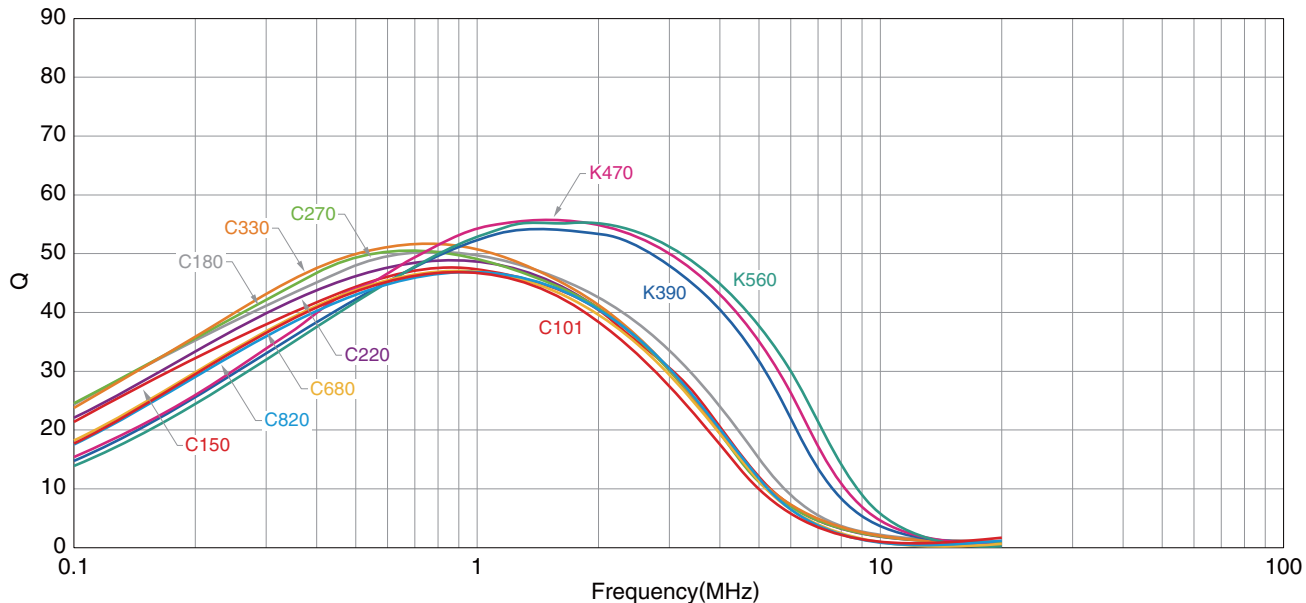

○ Measurement equipment

| Product No. | Manufacturer |
|--------------|----------------------|
| 4294A+16034G | Agilent Technologies |

* Equivalent measurement equipment may be used.

 Please be sure to request delivery specifications that provide further details on the features and specifications of the products for proper and safe use. Please note that the contents may change without any prior notice due to reasons such as upgrading.

MLF2012 Type

PACKAGING STYLE

REEL DIMENSIONS

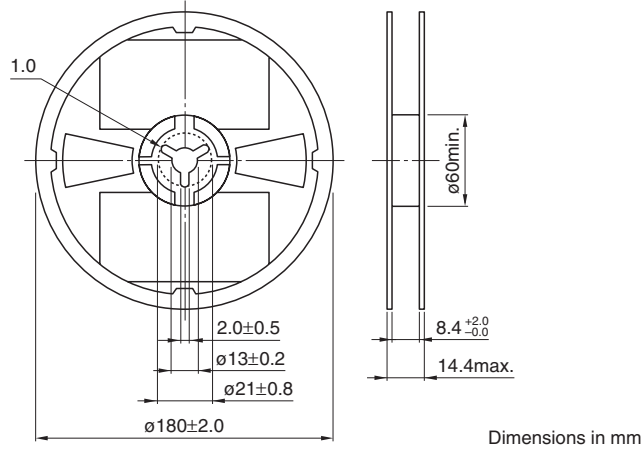

TAPE DIMENSIONS

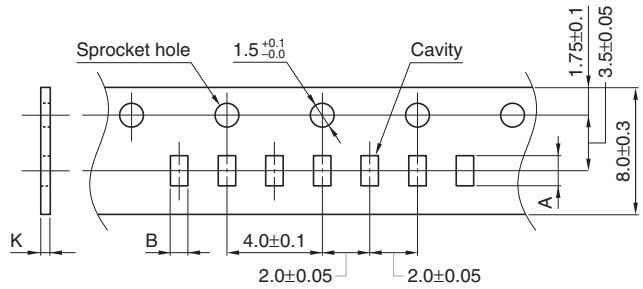

| Type | A | B | K | |
|---------|--------|---------|---------|----------|
| MLF2012 | t=0.85 | 2.3±0.2 | 1.5±0.2 | 1.1 max. |
| | t=1.25 | 2.3±0.2 | 1.5±0.2 | 1.5 max. |

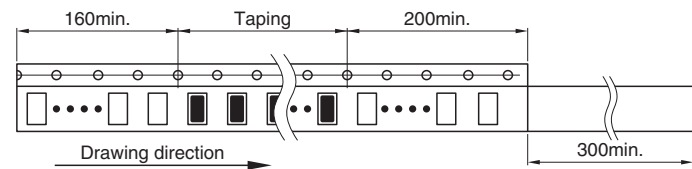

Dimensions in mm

 Please be sure to request delivery specifications that provide further details on the features and specifications of the products for proper and safe use. Please note that the contents may change without any prior notice due to reasons such as upgrading.