

IEC Appliance Inlet C14 with Filter, Line Switch 1- or 2-pole, Front or Rear Side Mounting

Standard- or Medical-Filter



Screw-on Version
from front side



Snap-In Version
from front side



Screw-on Version
from front side, protection class II

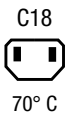

Description

- Panel Mount:
Screw-on version from front or rear side, snap-in version from front side
- 3 Functions:
Appliance Inlet protection class I or II, Line Switch 1- or 2-pole, Line filter in standard and medical version
- Quick connect terminals 6.3 x 0.8 mm

Approvals

- VDE Certificate Number: 40001522
- UL File Number: E72928

Characteristics

- Compact design with optimal shielding
- Rear side mounting for efficient cost-saving assembly
- All single elements are already wired
- Line switch non-illuminated or illuminated
- Universal line filter for standard applications
- Ideal for application with high transient loads
- Suitable for use in equipment according to IEC/UL 60950
- Suitable for use in medical equipment according to IEC/UL 60601-1

Other versions on request

- Solder terminals
- Other rocker marking
- Capacitance CX1

References

Alternative: version without line filter [DC11](#)
Substitute for type [KFB1](#); [KFB2](#)

Weblinks

[pdf-datasheet](#), [html-datasheet](#), [General Product Information](#), [Approvals](#), [CE declaration of conformity](#), [RoHS](#), [CHINA-RoHS](#), [REACH](#), [Mating Connectors](#), [e-Shop](#), [SCHURTER-Stock-Check](#), [Distributor-Stock-Check](#), [CAD-Drawings](#), [Accessories](#), [Wire Harnessing](#), [Detailed request for product](#)

Newly available variants corresponding to V-Lock mating cordset. The connector is equipped with a notch intended for use with the latching cordset. The cord latching system prevents against accidental removal of the cordset.

Technical Data

Ratings IEC	1 - 10A @ Ta 40 °C / 250VAC; 50Hz	Appliance-Inlet/-Outlet	C14 / C18 acc. to IEC 60320-1, UL 498, CSA C22.2 no. 42 (for cold conditions) pin-temperature 70 °C, 10A, Protection Class I or II
Ratings UL/CSA	1 - 10A @ Ta 40 °C / 125VAC; 60Hz	Line Switch	Rocker switch 1 or 2 pole, non-illuminated or illuminated, acc. to IEC 61058-1 Technical Details
Leakage Current	standard < 0.5mA (250V / 60Hz) medical < 5 µA (250 V / 60 Hz)	Line Filter	Standard and Medical Version, IEC 60939, UL 1283, CSA C22.2 no. 8 Technical Details
Dielectric Strength	> 1.7kVDC between L-N > 2.7kVDC between L/N-PE Test voltage (2sec)	MTBF	> 1'900'000h acc. to MIL-HB-217 F
Allowable Operation Temp.	-25 °C to 85 °C		
Climatic Category	25/085/21 acc. to IEC 60068-1		
Degree of Protection	from front side IP 40 acc. to IEC 60529		
Protection Class	Suitable for appliances with protection class I or II acc. to IEC 61140		
Terminal	Quick connect terminals 6.3 x 0.8 mm		
Panel Thickness s	Screw: max 8 mm Mounting screw torque max 0.5Nm Snap-in: 1 mm to 3 mm		
Material: Housing	Thermoplastic, black / white, UL 94V-0		

Screw-on mounting from front side (protection class II)

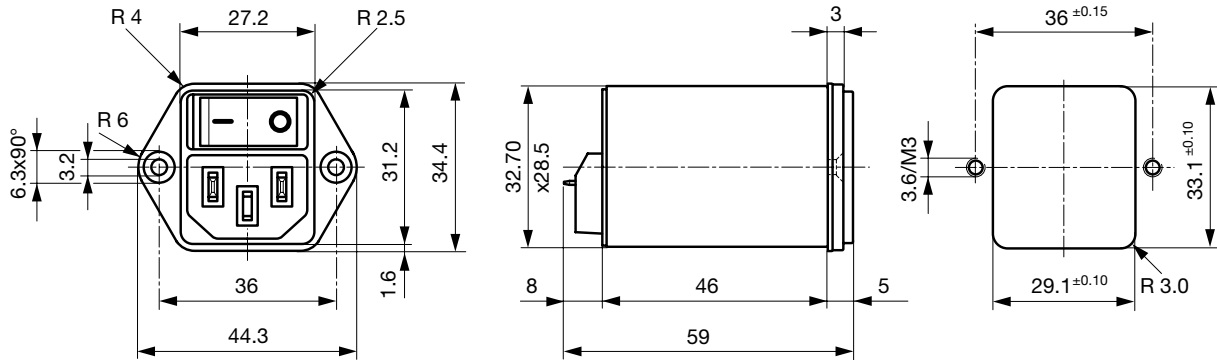

Screw-on version from rear side (protection class II)

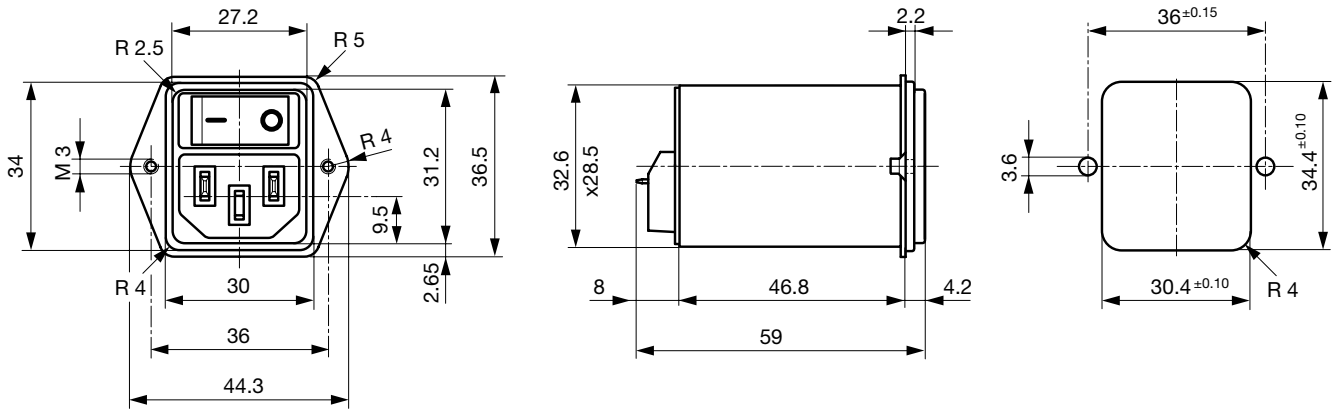

Snap-in mounting from front side (protection class II)

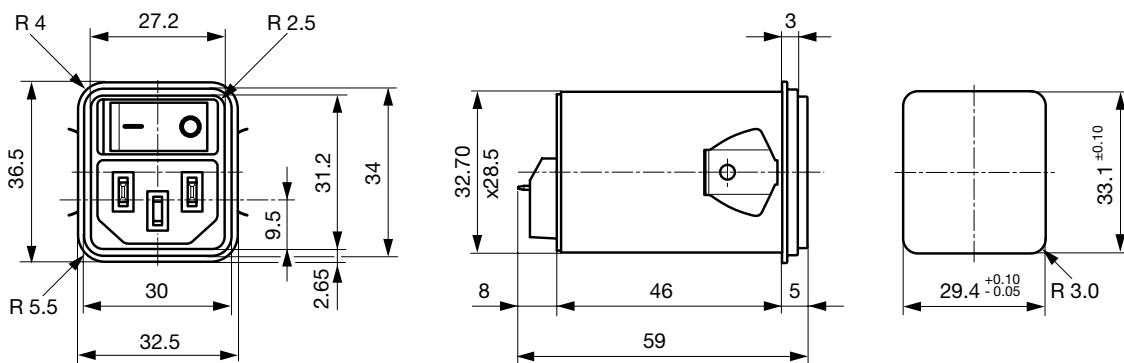

Technical Data of Filter-Components

Rated Current [A]	Filter-Type	Inductances L [mH]	Capacitance CX [nF]	Capacitance CY [nF]	R [MΩ]
1	Standard Version	2 x 10	100	2.2	1
2	Standard Version	2 x 4	100	2.2	1
4	Standard Version	2 x 1.5	100	2.2	1
6	Standard Version	2 x 0.8	100	2.2	1
10	Standard Version	2 x 0.3	100	2.2	1
1	Medical Version (M5)	2 x 10	100	-	1
2	Medical Version (M5)	2 x 4	100	-	1
4	Medical Version (M5)	2 x 1.5	100	-	1
6	Medical Version (M5)	2 x 0.8	100	-	1
10	Medical Version (M5)	2 x 0.3	100	-	1
1	Medical Version (M80)	2 x 10	100	0.47	1
2	Medical Version (M80)	2 x 4	100	0.47	1
4	Medical Version (M80)	2 x 1.5	100	0.47	1
6	Medical Version (M80)	2 x 0.8	100	0.47	1
10	Medical Version (M80)	2 x 0.3	100	0.47	1

Diagrams

Standard filter 1-pole

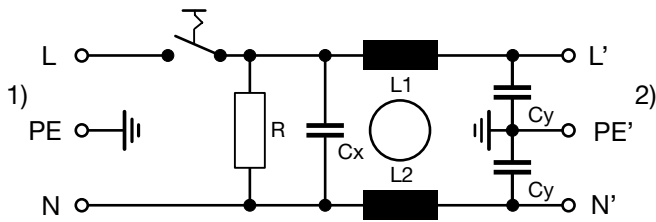

1) Line
2) Load

Standard filter 2-pole

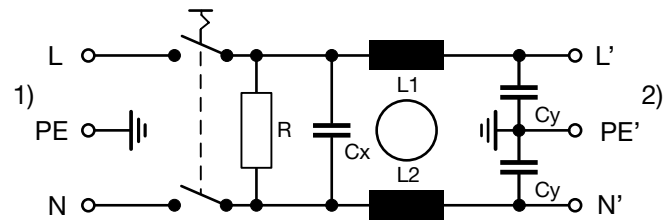

1) Line
2) Load

Medical filter 1-pole (M5)

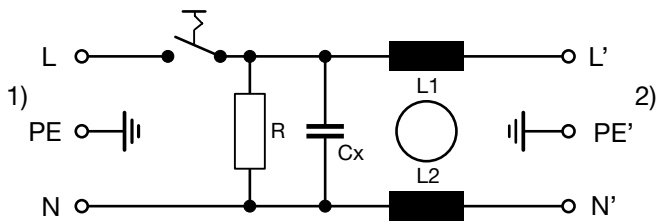

1) Line
2) Load

Medical filter 2-pole (M5)

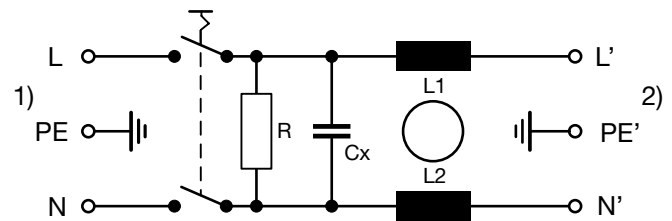

1) Line
2) Load

Standard filter 2-pole illuminated

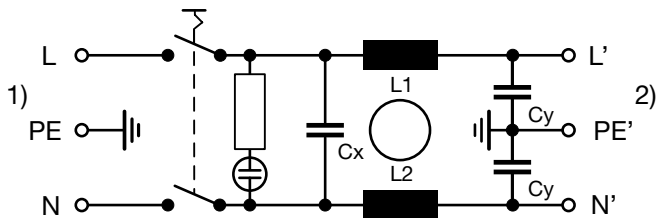

1) Line
2) Load

Medical Filter 2-pole (M5) illuminated

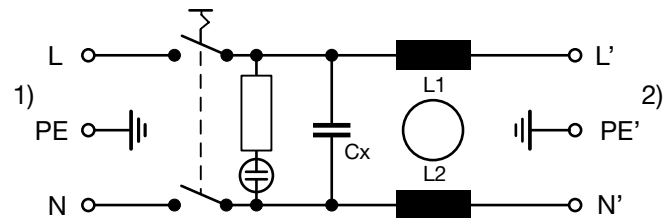

1) Line
2) Load

Medical filter 2-pole (M5) protection class II

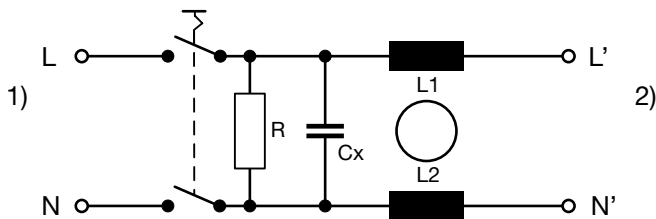

1) Line
2) Load

Attenuation Loss

Standard version

--- 50Ω differential mode ___ 50Ω common mode

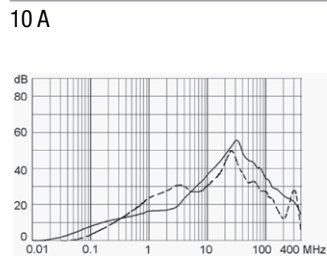
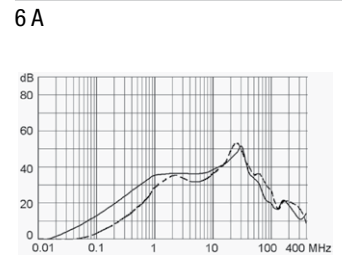
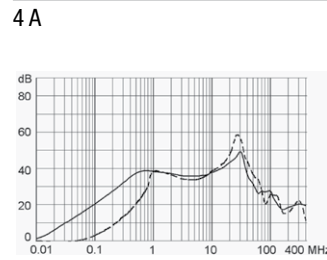
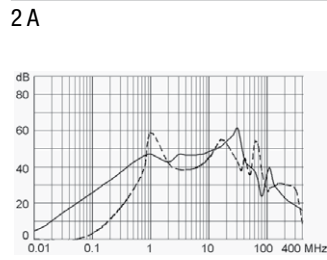
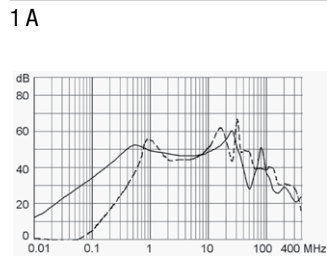

Medical version (M5)

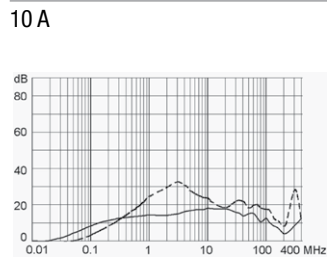
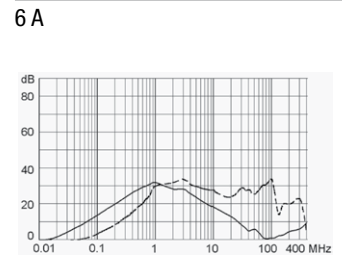
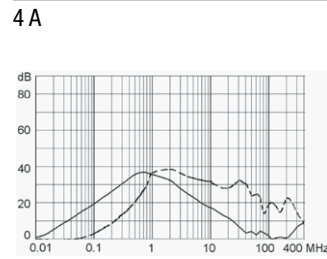
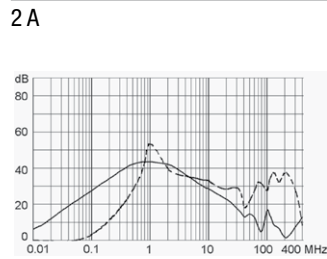
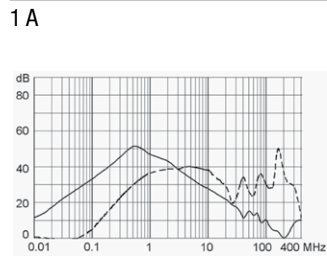

All Variants

Rated current	Filter-Type	Panel mounting	Mounting side	Line Switch	Illumination	Color	Pro-tection	Order Number
1	Standard Version	Snap-in	Front Side	1-pole	non-illuminated	black	I	DC12.1102.103
2	Standard Version	Snap-in	Front Side	1-pole	non-illuminated	black	I	DC12.2102.103
4	Standard Version	Snap-in	Front Side	1-pole	non-illuminated	black	I	DC12.3102.103
6	Standard Version	Snap-in	Front Side	1-pole	non-illuminated	black	I	DC12.4102.103
10	Standard Version	Snap-in	Front Side	1-pole	non-illuminated	black	I	DC12.5102.103
1	Standard Version	Snap-in	Front Side	2-pole	non-illuminated	black	I	DC12.1102.101
2	Standard Version	Snap-in	Front Side	2-pole	non-illuminated	black	I	DC12.2102.101
4	Standard Version	Snap-in	Front Side	2-pole	non-illuminated	black	I	DC12.3102.101
6	Standard Version	Snap-in	Front Side	2-pole	non-illuminated	black	I	DC12.4102.101
10	Standard Version	Snap-in	Front Side	2-pole	non-illuminated	black	I	DC12.5102.101
1	Standard Version	Screw	Front Side	1-pole	non-illuminated	black	I	DC12.1102.003
2	Standard Version	Screw	Front Side	1-pole	non-illuminated	black	I	DC12.2102.003
4	Standard Version	Screw	Front Side	1-pole	non-illuminated	black	I	DC12.3102.003
6	Standard Version	Screw	Front Side	1-pole	non-illuminated	black	I	DC12.4102.003
10	Standard Version	Screw	Front Side	1-pole	non-illuminated	black	I	DC12.5102.003

Rated current	Filter-Type	Panel mounting	Mounting side	Line Switch	Illumination	Color	Pro-tection	Order Number
10	Standard Version	Screw	Front Side	1-pole	non-illuminated	black	I	DC12.5102.003.21
1	Standard Version	Screw	Front Side	2-pole	non-illuminated	black	I	DC12.1102.001
2	Standard Version	Screw	Front Side	2-pole	non-illuminated	black	I	DC12.2102.001
4	Standard Version	Screw	Front Side	2-pole	non-illuminated	black	I	DC12.3102.001
6	Standard Version	Screw	Front Side	2-pole	non-illuminated	black	I	DC12.4102.001
10	Standard Version	Screw	Front Side	2-pole	non-illuminated	black	I	DC12.5102.001
10	Standard Version	Screw	Front Side	2-pole	non-illuminated	black	I	DC12.5102.001.21
1	Standard Version	Screw	Rear Side	1-pole	non-illuminated	black	I	DC12.1102.203
2	Standard Version	Screw	Rear Side	1-pole	non-illuminated	black	I	DC12.2102.203
4	Standard Version	Screw	Rear Side	1-pole	non-illuminated	black	I	DC12.3102.203
6	Standard Version	Screw	Rear Side	1-pole	non-illuminated	black	I	DC12.4102.203
10	Standard Version	Screw	Rear Side	1-pole	non-illuminated	black	I	DC12.5102.203
1	Standard Version	Screw	Rear Side	2-pole	non-illuminated	black	I	DC12.1102.201
2	Standard Version	Screw	Rear Side	2-pole	non-illuminated	black	I	DC12.2102.201
4	Standard Version	Screw	Rear Side	2-pole	non-illuminated	black	I	DC12.3102.201
6	Standard Version	Screw	Rear Side	2-pole	non-illuminated	black	I	DC12.4102.201
10	Standard Version	Screw	Rear Side	2-pole	non-illuminated	black	I	DC12.5102.201
1	Medical Version (M5)	Snap-in	Front Side	1-pole	non-illuminated	black	I	DC12.1202.103
2	Medical Version (M5)	Snap-in	Front Side	1-pole	non-illuminated	black	I	DC12.2202.103
4	Medical Version (M5)	Snap-in	Front Side	1-pole	non-illuminated	black	I	DC12.3202.103
6	Medical Version (M5)	Snap-in	Front Side	1-pole	non-illuminated	black	I	DC12.4202.103
10	Medical Version (M5)	Snap-in	Front Side	1-pole	non-illuminated	black	I	DC12.5202.103
1	Medical Version (M5)	Snap-in	Front Side	2-pole	non-illuminated	black	I	DC12.1202.101
1	Medical Version (M5)	Snap-in	Front Side	2-pole	non-illuminated	black	II	DC12.1202.121
1	Medical Version (M5)	Snap-in	Front Side	2-pole	non-illuminated	white	II	DC12.1202.131
2	Medical Version (M5)	Snap-in	Front Side	2-pole	non-illuminated	black	I	DC12.2202.101
2	Medical Version (M5)	Snap-in	Front Side	2-pole	non-illuminated	black	II	DC12.2202.121
2	Medical Version (M5)	Snap-in	Front Side	2-pole	non-illuminated	white	II	DC12.2202.131
4	Medical Version (M5)	Snap-in	Front Side	2-pole	non-illuminated	black	I	DC12.3202.101
4	Medical Version (M5)	Snap-in	Front Side	2-pole	non-illuminated	black	II	DC12.3202.121
4	Medical Version (M5)	Snap-in	Front Side	2-pole	non-illuminated	white	II	DC12.3202.131
6	Medical Version (M5)	Snap-in	Front Side	2-pole	non-illuminated	black	I	DC12.4202.101
6	Medical Version (M5)	Snap-in	Front Side	2-pole	non-illuminated	black	II	DC12.4202.121
6	Medical Version (M5)	Snap-in	Front Side	2-pole	non-illuminated	white	II	DC12.4202.131
10	Medical Version (M5)	Snap-in	Front Side	2-pole	non-illuminated	black	I	DC12.5202.101
10	Medical Version (M5)	Snap-in	Front Side	2-pole	non-illuminated	black	II	DC12.5202.121
10	Medical Version (M5)	Snap-in	Front Side	2-pole	non-illuminated	white	II	DC12.5202.131
6	Medical Version (M5)	Snap-in	Front Side	2-pole	illuminated green	black	I	DC12.4232.101
1	Medical Version (M5)	Screw	Front Side	1-pole	non-illuminated	black	I	DC12.1202.003
2	Medical Version (M5)	Screw	Front Side	1-pole	non-illuminated	black	I	DC12.2202.003
4	Medical Version (M5)	Screw	Front Side	1-pole	non-illuminated	black	I	DC12.3202.003
6	Medical Version (M5)	Screw	Front Side	1-pole	non-illuminated	black	I	DC12.4202.003
10	Medical Version (M5)	Screw	Front Side	1-pole	non-illuminated	black	I	DC12.5202.003
1	Medical Version (M5)	Screw	Front Side	2-pole	non-illuminated	black	I	DC12.1202.001
1	Medical Version (M5)	Screw	Front Side	2-pole	non-illuminated	black	II	DC12.1202.021
1	Medical Version (M5)	Screw	Front Side	2-pole	non-illuminated	white	II	DC12.1202.031
2	Medical Version (M5)	Screw	Front Side	2-pole	non-illuminated	black	I	DC12.2202.001
2	Medical Version (M5)	Screw	Front Side	2-pole	non-illuminated	black	II	DC12.2202.021
2	Medical Version (M5)	Screw	Front Side	2-pole	non-illuminated	white	II	DC12.2202.031
4	Medical Version (M5)	Screw	Front Side	2-pole	non-illuminated	black	I	DC12.3202.001
4	Medical Version (M5)	Screw	Front Side	2-pole	non-illuminated	black	II	DC12.3202.021
4	Medical Version (M5)	Screw	Front Side	2-pole	non-illuminated	white	II	DC12.3202.031
6	Medical Version (M5)	Screw	Front Side	2-pole	non-illuminated	black	I	DC12.4202.001
6	Medical Version (M5)	Screw	Front Side	2-pole	non-illuminated	black	I	DC12.4202.001.21
6	Medical Version (M5)	Screw	Front Side	2-pole	non-illuminated	black	II	DC12.4202.021

Rated current	Filter-Type	Panel mounting	Mounting side	Line Switch	Illumination	Color	Pro-tection	Order Number
6	Medical Version (M5)	Screw	Front Side	2-pole	non-illuminated	white	II	DC12.4202.031
10	Medical Version (M5)	Screw	Front Side	2-pole	non-illuminated	black	I	DC12.5202.001
10	Medical Version (M5)	Screw	Front Side	2-pole	non-illuminated	black	I	DC12.5202.001.21
10	Medical Version (M5)	Screw	Front Side	2-pole	non-illuminated	black	II	DC12.5202.021
10	Medical Version (M5)	Screw	Front Side	2-pole	non-illuminated	white	II	DC12.5202.031
1	Medical Version (M5)	Screw	Rear Side	2-pole	non-illuminated	black	I	DC12.1202.201
2	Medical Version (M5)	Screw	Rear Side	2-pole	non-illuminated	black	I	DC12.2202.201
4	Medical Version (M5)	Screw	Rear Side	2-pole	non-illuminated	black	I	DC12.3202.201
6	Medical Version (M5)	Screw	Rear Side	2-pole	non-illuminated	black	I	DC12.4202.201
10	Medical Version (M5)	Screw	Rear Side	2-pole	non-illuminated	black	I	DC12.5202.201
1	Medical Version (M80)	Screw	Rear Side	2-pole	non-illuminated	black	I	DC12.1602.201
2	Medical Version (M80)	Screw	Rear Side	2-pole	non-illuminated	black	I	DC12.2602.201
4	Medical Version (M80)	Screw	Rear Side	2-pole	non-illuminated	black	I	DC12.3602.201
6	Medical Version (M80)	Screw	Rear Side	2-pole	non-illuminated	black	I	DC12.4602.201
10	Medical Version (M80)	Screw	Rear Side	2-pole	non-illuminated	black	I	DC12.5602.201

Most Popular.

Availability for all products can be searched real-time: <http://www.schurter.com/en/Stock-Check/Stock-Check-SCHURTER>

Suffix "21" corresponds to the version with V-Lock mating cordset. The connector is equipped with a notch intended for use with the latching cordset. The cord latching system prevents against accidental removal of the cordset. Available only for screw-on versions.

Packaging unit 10 Pcs

Accessories

Description



Wire Harness
Wire harness for SCHURTER products

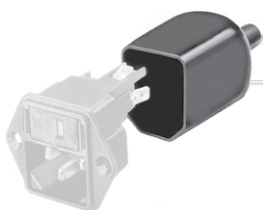

Assorted Covers
Rear Cover



Cord retaining kits
Cord retaining strain relief

Flat head, A	4700.0001
Countersunk, B	4700.0002

Mating Outlets/Connectors

Category / Description

[Connector Overview complete](#)



4782 Mounting: Power Cord, 3 x 1 mm ² / 3 x 18 AWG, Cable, Connector: IEC C13	4782
4022 Mounting: Power Supply Cord, 3 x 1.5 mm ² , Screw clamps, Connector: IEC C13	4022
4785 Mounting: Power Cord, 3 x 1 mm ² / 3 x 18 AWG, Cable, Connector: IEC C13	4785
4300-06 Mounting: Power Cord, 3 x 1 mm ² / 3 x 18 AWG, Cable, Connector: IEC C13	4300-06
4012 Mounting: Power Supply Cord, 3 x 1.5 mm ² , Screw clamps, Connector: IEC C13	4012
Connector further types to DC12	...

[Interconnection Cord Overview complete](#)



Cord Sets 10 A, Interconnection, 1.0 m, Connector IEC C13, cord end:	6007.0212
Cord Sets 10 A, Interconnection, 2.0 m, Connector IEC C13, cord end:	6007.0214
Interconnection Cord further types to DC12	...

[Power Supply Cord Overview complete](#)



Cord Sets 10 A, Europlug, 2.0 m, Connector IEC C13, cord end:	6004.0114
Cord Sets 10 A, Europlug, 2.5 m, Connector IEC C13, cord end:	6004.0215
Cord Sets 10 A, Europlug, 2.5 m, Connector IEC C13, cord end:	6003.0215
Cord Sets 10 A, Europlug, Black, 2.5 m, H05VV-F 3G1,0mm2, Connector IEC C13, 002500 mm, cord end:	6004.0225
Cord Sets 10 A, diverse, Black, 5.0 m, H05VV-F 3G1,0mm2, Connector IEC C13, 002500 mm, cord end:	6052.0026
Power Supply Cord further types to DC12	...

[Power Supply or Interconnection Cord Overview complete](#)



Kabelverbindung 10 A, United Kingdom, 2.0 m, Connector IEC C13, cord end:	6045.0114
Kabelverbindung 10 A, diverse, diverse m, Connector IEC C13, cord end:	6003.0205
Kabelverbindung 10 A, diverse, diverse m, Connector IEC C13, cord end:	6026.0205
Kabelverbindung 10 A, diverse, diverse m, Connector IEC C13, cord end:	6049.0007
Power Supply or Interconnection Cord further types to DC12	...

Mating Outlets/Connectors shuttered



[Power Cord Overview complete](#)

VAC13KS, Overview, diverse Connector IEC C13, cord end:	VAC13KS
Power Cord further types to DC12	...