

1

2

3

4

5

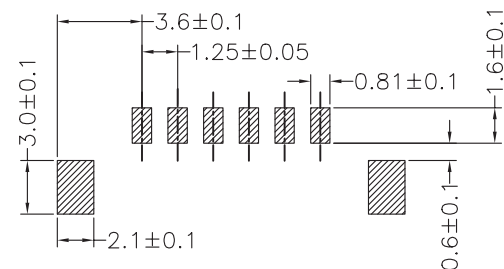

PCB LAYOUT - COMPONENT VIEW

TECHNICAL CHARACTERISTICS

MATERIAL
 INSULATOR: NYLON 46
 FLAMABILITY RATING: UL94-V0
 COLOR: IVORY
 CONTACT MATERIAL: COPPER ALLOY
 CONTACT TYPE: STAMPED
 CONTACT PLATING: TIN
 QUALITY CLASS: 25 MATING CYCLES
 PITCH: 1.25 MM

ENVIRONMENTAL
 OPERATING TEMPERATURE: -40 UP TO 85°C
 COMPLIANCE: LEAD FREE AND ROHS

ELECTRICAL
 CURRENT RATING: 1 A
 WORKING VOLTAGE: 125 VAC
 INSULATOR RESISTANCE: >100 MOHM
 DIELECTRIC WITHSTANDING VOLTAGE: 250 VAC/MN
 CONTACT RESISTANCE: 20 mOHM MAX

SOLDERING
 JEDEC LEAD FREE REFLOW SOLDERING PROCESS

PACKAGING
 TAPE AND REEL

DIMENSION

A = 1.25 x (NB PIN - 1)
 B = 1.25 x (NB PIN + 1) + 3.5
 C = 1.25 x (NB PIN + 1) + 0.5

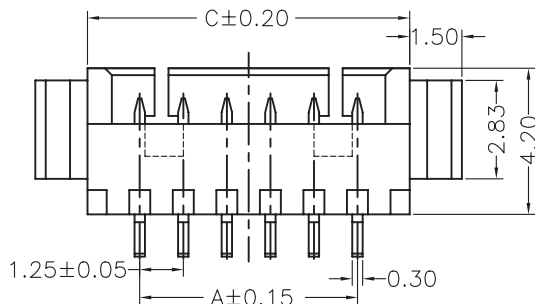
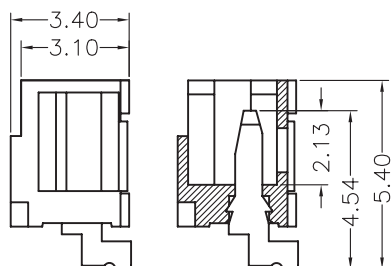
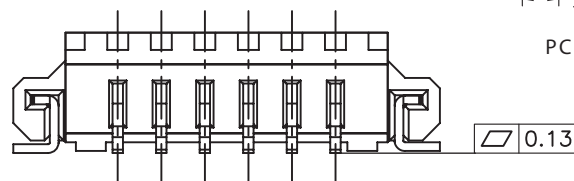

4~15P

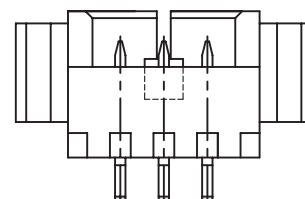

2P;3P

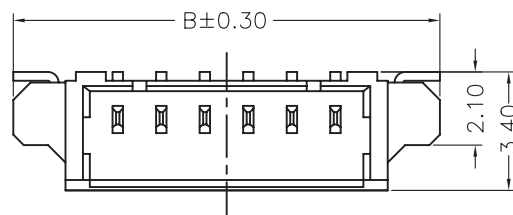

RoHS Compliant

PROJECTION:

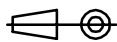

GENERAL TOLERANCE

.X = +/- 0.2

.XX = +/- 0.15



APPROVAL: BBu

UNIT: MM

SCALE:

SHEET: 1/3

DRAW: ANDY

DESCRIPTION: 1.25 MM SMT MALE HORIZONTAL SHROUDED HEADER

WERI PART NO: 653 1xx 131 822

SIZE

A4

REV	DATE	FILE	BY
H	06-AUG-15	COLOR	AK

1

2

3

4

5

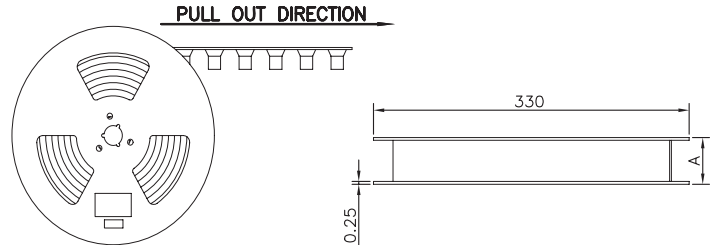

Note:

- 1.Material : Black Conductive Polystyrene Alloy
100% recyclable.
- 2.Thickness : 0.35±0.05mm
- 3.Component load per 13" reel :1500 pcs.
- 4.CARTON SIZE:350*350*296(MM)

Pin No	W	A	PCS/R	R/CTN	Q'TY
02	24	29	1500	7	10500
03	24	29	1500	7	10500
04	24	29	1500	7	10500
05	24	29	1500	7	10500
06	24	29	1500	7	10500
07	24	29	1500	7	10500
08	24	29	1500	7	10500
09	24	29	1500	7	10500
10	32	37	1500	6	9000
11	32	37	1500	6	9000
12	44	37	1500	6	9000
13	32	37	1500	6	9000
14	32	37	1500	6	9000
15	44	49	1500	5	7500

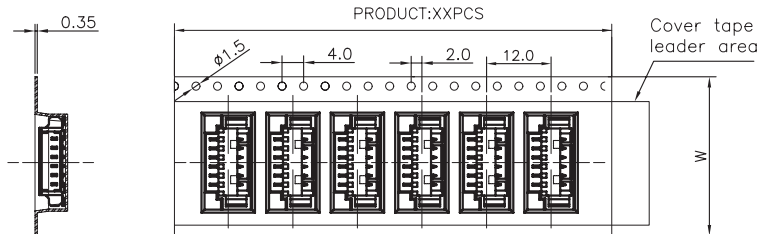

For Reel width (dimension W)24mm ,Single row hole

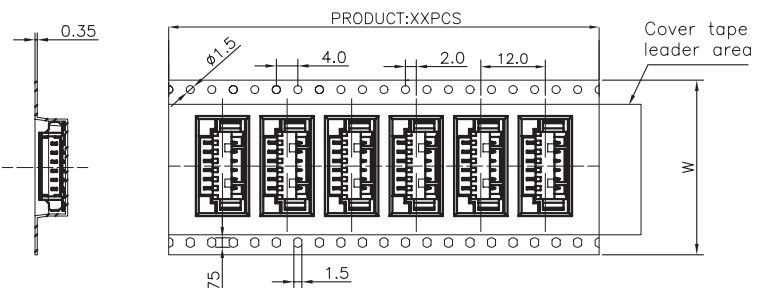

For Reel width (dimension W)32,44mm ,Double rows hole

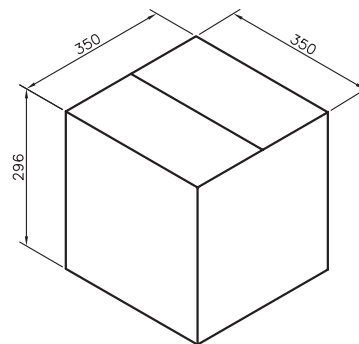

RoHS Compliant			
G			
F			
E			
D			
C			
B			
A			
REV	DATE	FILE	BY

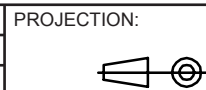

APPROVAL: BBu

GENERAL TOLERANCE

.X = +/- 0.2

.XX = +/- 0.15

UNIT: MM

SCALE:

SHEET: 2/3

DRAW: PEARL



DESCRIPTION: 1.25 MM SMT MALE HORIZONTAL SHROUDED HEADER

WERI PART NO: 653 1xx 131 822

SIZE

A4

A

B

C

D

1

2

3

4

5

Cautions and Warnings:

This electronic component is designed and developed with the intention for use in general electronics equipments.

Before incorporating the components into any equipments in the field such as aerospace, aviation, nuclear control, submarine, transportation, (automotive control, train control, ship control), transportation signal, disaster prevention, medical, public information network etc. where higher safety and reliability are especially required or if there is possibility of direct damage or injury to human body, Würth Elektronik must be asked for a written approval.

In addition, even electronic component in general electronic equipments, when used in electrical circuits that require high safety, reliability functions or performance, the sufficient reliability evaluation-check for the safety must be performed before by the user before usage.

A

B

C

RoHS Compliant

G				PROJECTION: 	GENERAL TOLERANCE .X = +/- 0.2 .XX = +/- 0.15		
F							
E							
D							
C				APPROVAL: JC	UNIT: MM	DESCRIPTION: DISCLAIMER	SIZE A4
B					SCALE:		
A	10-SEP-14	PDF	QL		SHEET: 3/3	WERI PART NO: DISCLAIMER	
REV	DATE	FILE	BY		DRAW: QL		

D