

UF07A THRU UF07M



1 Amp Ultra Fast Recovery

Features

- Low Cost
- Ultra fast Recovery
- High Reliability
- Case Material: Molded Plastic. UL Flammability Classification Rating 94V-0 and MSL Rating 1

Maximum Ratings

- Operating Temperature: -65°C to +150°C
- Storage Temperature: -65°C to +150°C
- Maximum Thermal Resistance; 180°C/W Junction To Ambient.

MCC Part Number	Device Marking	Maximum Recurrent Peak Reverse Voltage	Maximum RMS Voltage	Maximum DC Blocking Voltage
UF07A	U1	50V	35V	50V
UF07B	U2	100V	70V	100V
UF07D	U3	200V	140V	200V
UF07G	U4	400V	280V	400V
UF07J	U5	600V	420V	600V
UF07K	U6	800V	560V	800V
UF07M	U7	1000V	700V	1000V

Electrical Characteristics @ 25°C Unless Otherwise Specified

Average Forward Current	$I_{F(AV)}$	1.0A	$T_L = 90^\circ\text{C}$
Peak Forward Surge Current	I_{FSM}	30A	8.3ms, half sine
Maximum Instantaneous Forward Voltage UF07A-07D UF07G UF07J-07M	V_F	1.0V 1.40V 1.70V	$I_{FM} = 1.0A;$ $T_a = 25^\circ\text{C}$
Maximum DC Reverse Current At Rated DC Blocking Voltage	I_R	10 μA 50 μA	$T_a = 25^\circ\text{C}$ $T_a = 125^\circ\text{C}$
Maximum Reverse Recovery Time UF07A-07D UF07G U07J-07M	T_{rr}	35ns 50ns 75ns	$I_F = 0.5A, I_R = 1.0A,$ $T_{rr} = 0.25A$
Typical Junction Capacitance	C_J	20pF	Measured at 1.0MHz, $V_R = 4.0V$

Recovery Silicon Rectifier 50 to 1000 Volts

SOD-123FL

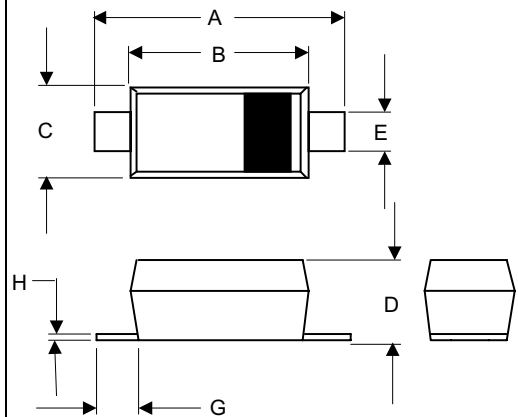

DIM	DIMENSIONS				NOTE
	INCHES		MM		
	MIN	MAX	MIN	MAX	
A	.140	.152	3.55	3.85	
B	.100	.112	2.55	2.85	
C	.055	.071	1.40	1.80	
D	.037	.053	0.95	1.35	
E	.020	.039	0.50	1.00	
G	.010	-----	0.25	-----	
H	-----	.008	-----	.20	

SUGGESTED SOLDER PAD LAYOUT

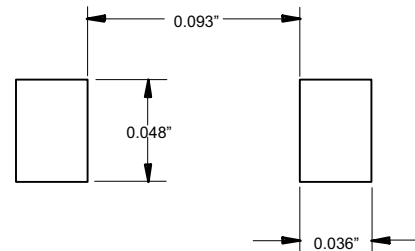

UF07A THRU UF07M

Figure 1
Typical Forward Characteristics

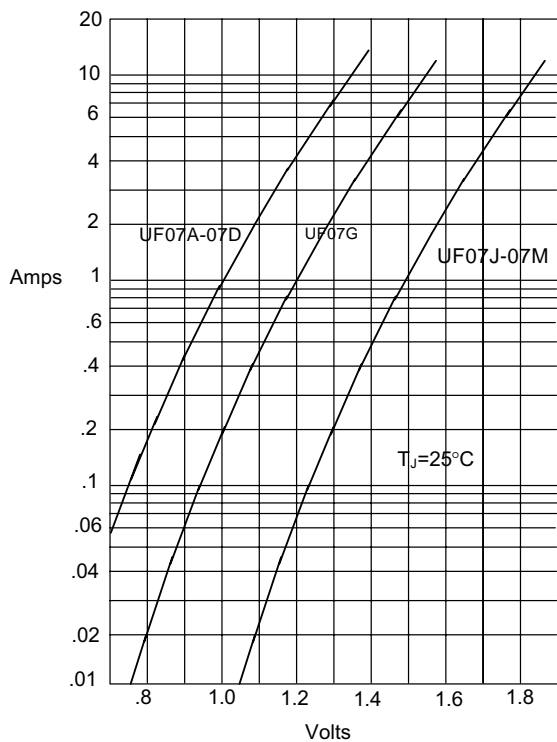

Instantaneous Forward Current - Amperes versus
Instantaneous Forward Voltage - Volts

Figure 2
Forward Derating Curve

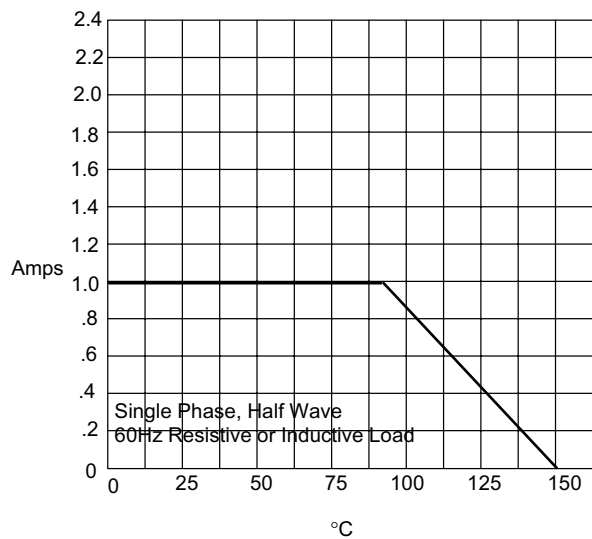

Average Forward Rectified Current - Amperes versus
Lead Temperature - $^\circ\text{C}$

Figure 3
Junction Capacitance

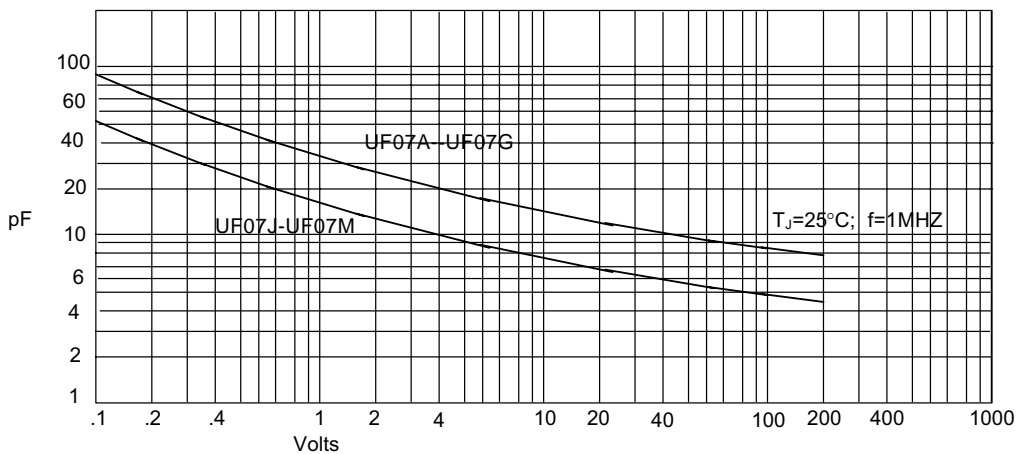

Junction Capacitance - pF versus
Reverse Voltage - Volts

Figure 4
Peak Forward Surge Current

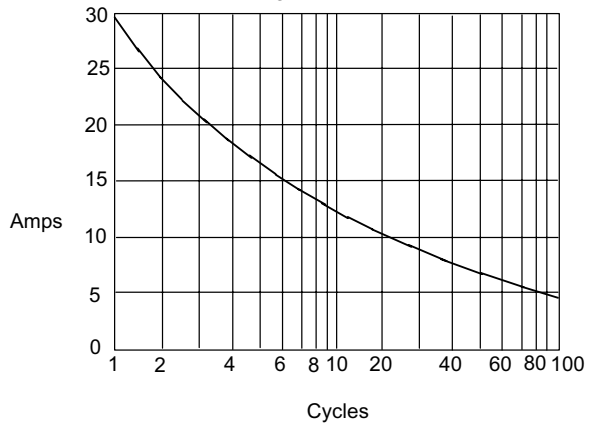

Peak Forward Surge Current - Amperes *versus*
Number Of Cycles At 60Hz - Cycles

Figure 5
Reverse Recovery Time Characteristic And Test Circuit Diagram

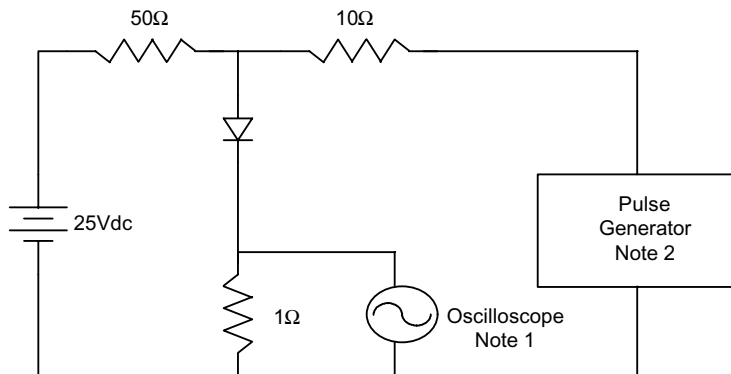

- Notes:
1. Rise Time = 7ns max.
Input impedance = 1 megohm, 22pF
 2. Rise Time = 10ns max.
 3. Resistors are non-inductive

