



OD2-P85W2010

OD Value

DISPLACEMENT MEASUREMENT SENSORS

SICK
Sensor Intelligence.



Ordering information

Type	Part no.
OD2-P85W2010	6036613

Other models and accessories → www.sick.com/OD_Value



Detailed technical data

Performance

Measuring range	65 mm ... 105 mm, 6 % ... 90 % remission
Resolution	10 μm ¹⁾
Repeatability	30 μm ^{2) 1) 3) 4)}
Linearity	± 40 μm ^{1) 5) 4) 6)}
Response time	1 ms / 10 ms / 35 ms ⁷⁾
Measuring frequency	2 kHz
Light source	Laser, red
Laser class	2 (EN 60825-1) ⁸⁾
Typ. light spot size (distance)	0.8 mm x 1.3 mm (85 mm)
Additional function	Mean-value setting 1 ... 64x, automatic sensitivity adjustment, Analog outputs can be taught in, Invertable analog output, Teach-in of switching output, Invertable switching output, multi-functional input: laser-off / external teach-in / trigger, switching mode: distance to object (DtO), switching mode: window (Wnd)

¹⁾ At averaging function medium.

²⁾ 6 % ... 90 % remission.

³⁾ Constant ambient conditions.

⁴⁾ For best performance consider warm up time ≤ 5 minutes.

⁵⁾ Measurement on 90 % remission (ceramic, white)

⁶⁾ When calibrated in the application regularly.

⁷⁾ Automatic sensitivity adjustment ≤ 4 ms, 6 ms for the models with measuring range of 100 mm ... 400 mm.

⁸⁾ Wavelength: 655 nm, max. output: 1 mW.

Interfaces

Switching output	2 x PNP (100 mA) ¹⁾
Multifunctional input (MF)	1 x MF ²⁾
Data interface	1 x 4 mA ... 20 mA (< 300 Ω)

¹⁾ PNP: HIGH = V_S - (< 2 V) / LOW = < 2 V; NPN: HIGH = < 2 V / LOW = V_S.

²⁾ MF can be used as laser-off, trigger, external teach-in, or deactivated; response time ≤ 3 ms.

Mechanics/electronics

Supply voltage V_s	DC 12 V ... 24 V ¹⁾
Power consumption	≤ 2.88 W ²⁾
Warm-up time	≤ 30 min
Housing material	PBT housing with PMMA lens
Connection type	Male connector, M12, 8-pin
Indication	Distance bar graph, up to 8 status LEDs
Weight	70 g

¹⁾ DC 12 V (-5 %) ... 24 V (+10 %); DC 18 V (-5 %) ... DC 24 V (+10 %) when using analog voltage output.

²⁾ Without load, with current output.

Ambient data

Enclosure rating	IP 67
Protection class	III
Ambient temperature	Operation: -10 °C ... $+40$ °C Storage: -20 °C ... $+60$ °C
Relative air humidity (non-condensing)	35 % ... 95 %
Temperature drift	± 0.08 % FS/K (FS = Full Scale = Measuring range of sensor)
Typ. Ambient light immunity	Artificial light: $\leq 3,000$ lx Sunlight: $\leq 10,000$ lx
Vibration resistance	10 Hz ... 55 Hz (amplitude 1.5 mm, x-, y-, z-axis 2 hours each)
Shock resistance	50 G (x, y, z axis 3 times each)

Dimensional drawing (Dimensions in mm (inch))

OD2-x85W20xx

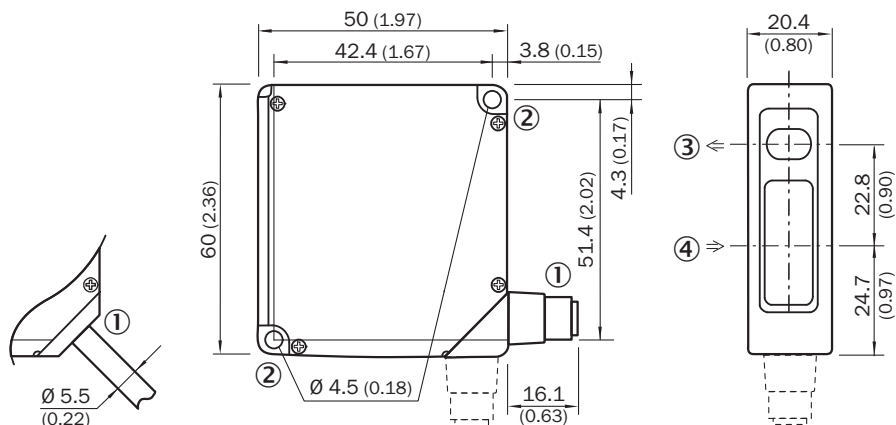

- ① 2 m cable or M12 connector; 90° rotatable
- ② Mounting hole, $\varnothing 4.5$ mm
- ③ Optical axis sender
- ④ Optical axis receiver

Connection type

OD2-xxxxxA0 OD2-xxxxxC0 OD2-xxxxxI0 OD2-xxxxxU0 connector M12, 8-pin

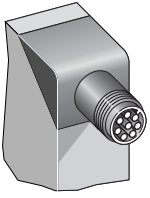

Connection diagram

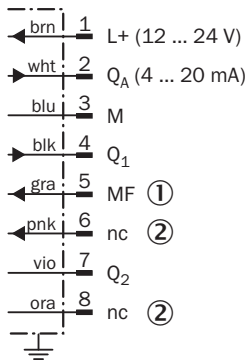

- ① Multifunctional input (MF)
- ② Not assigned

Adjustment possible

OD2-xxxxxlx

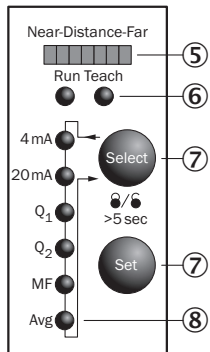

- ⑤ Distance indicator
- ⑥ Mode indicator (Run/Teach)
- ⑦ Operating elements
- ⑧ Status indicator in- and outputs (Run-mode)/menu indicator (Teach-mode)

Light spot size

OD2-x85W20xx

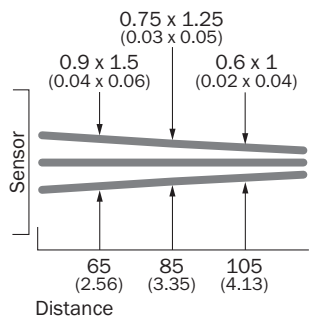

All dimensions in mm (inch)

Linearity

OD2-x85xxxxx

Linearity [%FS]

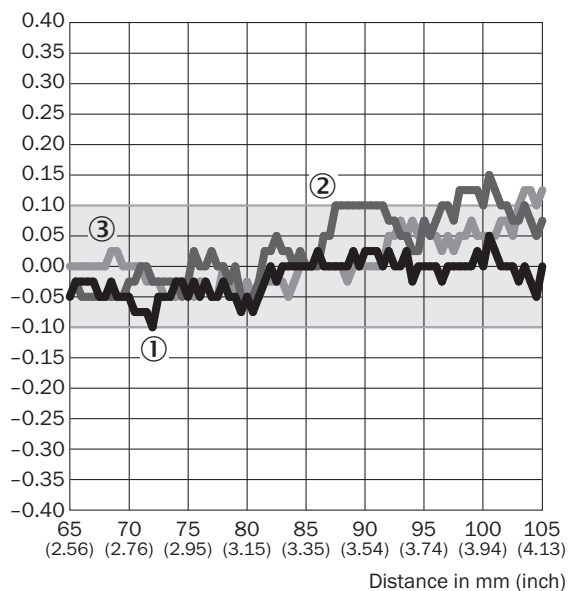

- ① White ceramic
- ② Black paper
- ③ Stainless steel

Recommended accessories

Other models and accessories → www.sick.com/OD_Value

	Brief description	Type	Part no.
	Plug connectors and cables		

	Brief description	Type	Part no.
	Head A: female connector, M12, 8-pin, straight Head B: cable Cable: special color code, PVC, shielded, 2 m	DOL-1208-G02MF	6020663
	Head A: female connector, M12, 8-pin, straight Head B: cable Cable: special color code, PVC, shielded, 5 m	DOL-1208-G05MF	6020664
	Head A: female connector, M12, 8-pin, straight Head B: cable Cable: special color code, PVC, shielded, 10 m	DOL-1208-G10MF	6048434

SICK AT A GLANCE

SICK is one of the leading manufacturers of intelligent sensors and sensor solutions for industrial applications. A unique range of products and services creates the perfect basis for controlling processes securely and efficiently, protecting individuals from accidents and preventing damage to the environment.

We have extensive experience in a wide range of industries and understand their processes and requirements. With intelligent sensors, we can deliver exactly what our customers need. In application centers in Europe, Asia and North America, system solutions are tested and optimized in accordance with customer specifications. All this makes us a reliable supplier and development partner.

Comprehensive services complete our offering: SICK LifeTime Services provide support throughout the machine life cycle and ensure safety and productivity.

For us, that is “Sensor Intelligence.”

WORLDWIDE PRESENCE:

Contacts and other locations –www.sick.com