



**TAOS Inc.**

**is now**

**ams AG**

The technical content of this TAOS datasheet is still valid.

**Contact information:**

**Headquarters:**

ams AG

Tobelbaderstrasse 30

8141 Unterpremstaetten, Austria

Tel: +43 (0) 3136 500 0

e-Mail: [ams\\_sales@ams.com](mailto:ams_sales@ams.com)

Please visit our website at [www.ams.com](http://www.ams.com)

- 128 × 1 Sensor-Element Organization
- 400 Dots-Per-Inch (DPI) Sensor Pitch
- High Linearity and Uniformity
- Wide Dynamic Range . . . 4000:1 (72 dB)
- Output Referenced to Ground
- Low Image Lag . . . 0.5% Typ
- Operation to 8 MHz
- Single 3-V to 5-V Supply
- Rail-to-Rail Output Swing (AO)
- No External Load Resistor Required
- Replacement for TSL1401R-LF
- RoHS Compliant

CL PACKAGE  
(TOP VIEW)

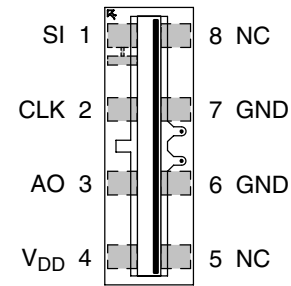

NC – No internal connection  
Package Drawing is Not to Scale

### Description

The TSL1401CL linear sensor array consists of a 128 × 1 array of photodiodes, associated charge amplifier circuitry, and an internal pixel data-hold function that provides simultaneous-integration start and stop times for all pixels. The array is made up of 128 pixels, each of which has a photo-sensitive area of 3,524.3 square micrometers. There is 8- $\mu$ m spacing between pixels. Operation is simplified by internal control logic that requires only a serial-input (SI) signal and a clock.

### Functional Block Diagram

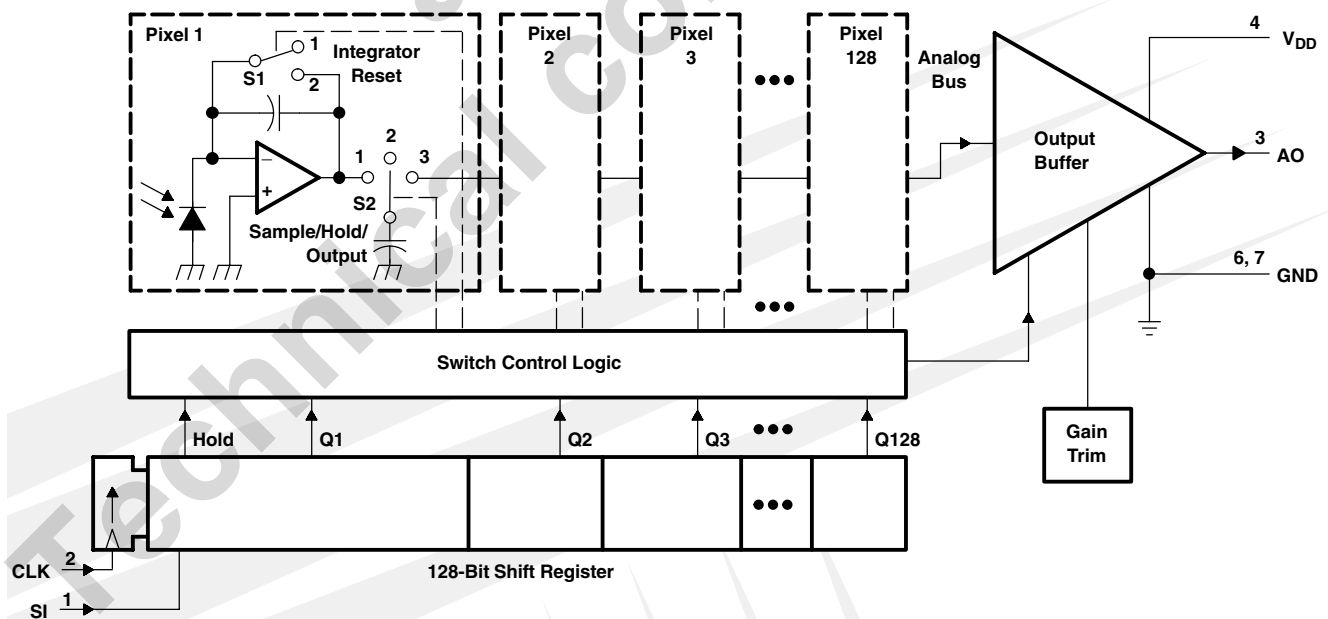

# TSL1401CL

## 128 × 1 LINEAR SENSOR ARRAY WITH HOLD

TAOS136 – JULY 2011

### Terminal Functions

TERMINAL NAME	NO.	DESCRIPTION
AO	3	Analog output.
CLK	2	Clock. The clock controls charge transfer, pixel output, and reset.
GND	6, 7	Ground (substrate). All voltages are referenced to the substrate.
NC	5, 8	No internal connection.
SI	1	Serial input. SI defines the start of the data-out sequence.
V <sub>DD</sub>	4	Supply voltage. Supply voltage for both analog and digital circuits.

### Detailed Description

The sensor consists of 128 photodiodes arranged in a linear array. Light energy impinging on a photodiode generates photocurrent, which is integrated by the active integration circuitry associated with that pixel.

During the integration period, a sampling capacitor connects to the output of the integrator through an analog switch. The amount of charge accumulated at each pixel is directly proportional to the light intensity and the integration time.

The output and reset of the integrators is controlled by a 128-bit shift register and reset logic. An output cycle is initiated by clocking in a logic 1 on SI. For proper operation, after meeting the minimum hold time condition, SI must go low before the next rising edge of the clock. An internal signal, called Hold, is generated from the rising edge of SI and transmitted to analog switches in the pixel circuit. This causes all 128 sampling capacitors to be disconnected from their respective integrators and starts an integrator reset period. As the SI pulse is clocked through the shift register, the charge stored on the sampling capacitors is sequentially connected to a charge-coupled output amplifier that generates a voltage on analog output AO. Simultaneously, during the first 18 clock cycles, all pixel integrators are reset, and the next integration cycle begins on the 19<sup>th</sup> clock. On the 129<sup>th</sup> clock rising edge, the SI pulse is clocked out of the shift register and the analog output AO assumes a high impedance state. Note that this 129<sup>th</sup> clock pulse is required to terminate the output of the 128<sup>th</sup> pixel, and return the internal logic to a known state. If a minimum integration time is desired, the next SI pulse may be presented after a minimum delay of  $t_{qt}$  (pixel charge transfer time) after the 129<sup>th</sup> clock pulse.

AO is an op amp-type output that does not require an external pull-down resistor. This design allows a rail-to-rail output voltage swing. With V<sub>DD</sub> = 5 V, the output is nominally 0 V for no light input, 2 V for normal white level, and 4.8 V for saturation light level. When the device is not in the output phase, AO is in a high-impedance state.

The voltage developed at analog output (AO) is given by:

$$V_{out} = V_{drk} + (R_e)(E_e)(t_{int})$$

where:

- V<sub>out</sub> is the analog output voltage for white condition
- V<sub>drk</sub> is the analog output voltage for dark condition
- R<sub>e</sub> is the device responsivity for a given wavelength of light given in V/(μJ/cm<sup>2</sup>)
- E<sub>e</sub> is the incident irradiance in μW/cm<sup>2</sup>
- t<sub>int</sub> is integration time in seconds

A 0.1 μF bypass capacitor should be connected between V<sub>DD</sub> and ground as close as possible to the device.

The TSL1401CL is intended for use in a wide variety of applications, including: image scanning, mark and code reading, optical character recognition (OCR) and contact imaging, edge detection and positioning, and optical linear and rotary encoding.

### Absolute Maximum Ratings†

Supply voltage range, $V_{DD}$ .....	-0.3 V to 6 V
Input voltage range, $V_I$ .....	-0.3 V to $V_{DD} + 0.3V$
Input clamp current, $I_{IK}$ ( $V_I < 0$ ) or ( $V_I > V_{DD}$ ) .....	-20 mA to 20 mA
Output clamp current, $I_{OK}$ ( $V_O < 0$ or $V_O > V_{DD}$ ) .....	-25 mA to 25 mA
Voltage range applied to any output in the high impedance or power-off state, $V_O$ ...	-0.3 V to $V_{DD} + 0.3 V$
Continuous output current, $I_O$ ( $V_O = 0$ to $V_{DD}$ ) .....	-25 mA to 25 mA
Continuous current through $V_{DD}$ or GND .....	-40 mA to 40 mA
Analog output current range, $I_O$ .....	-25 mA to 25 mA
Maximum light exposure at 638 nm .....	5 mJ/cm <sup>2</sup>
Operating free-air temperature range, $T_A$ .....	-25°C to 85°C
Storage temperature range, $T_{stg}$ .....	-25°C to 85°C
Lead temperature 1,6 mm (1/16 inch) from case for 10 seconds‡ .....	260°C
ESD tolerance, human body model .....	2000 V

† Stresses beyond those listed under “Absolute Maximum Ratings” may cause permanent damage to the device. These are stress ratings only, and functional operation of the device at these or any other conditions beyond those indicated under “Recommended Operating Conditions” is not implied. Exposure to absolute-maximum-rated conditions for extended periods may affect device reliability.

‡ Not recommended for solder reflow.

### Recommended Operating Conditions (see Figure 1 and Figure 2)

	MIN	NOM	MAX	UNIT
Supply voltage, $V_{DD}$	3	5	5.5	V
Input voltage, $V_I$	0		$V_{DD}$	V
High-level input voltage, $V_{IH}$	2		$V_{DD}$	V
Low-level input voltage, $V_{IL}$	0		0.8	V
Wavelength of light source, $\lambda$	400		1000	nm
Clock frequency, $f_{clock}$	5		8000	kHz
Sensor integration time, $t_{int}$ (see Note 1)	0.03375		100	ms
Setup time, serial input, $t_{su(SI)}$	20			ns
Hold time, serial input, $t_h(SI)$ (see Note 2)	0			ns
Operating free-air temperature, $T_A$	0		70	°C

NOTES: 1. Integration time is calculated as follows:

$$t_{int(min)} = (128 - 18) \times \text{clock period} + 20 \mu\text{s}$$

where 128 is the number of pixels in series, 18 is the required logic setup clocks, and 20  $\mu\text{s}$  is the pixel charge transfer time ( $t_{qt}$ )

2. SI must go low before the rising edge of the next clock pulse.



# TSL1401CL

## 128 × 1 LINEAR SENSOR ARRAY WITH HOLD

TAOS136 – JULY 2011

**Electrical Characteristics at  $f_{\text{clock}} = 1 \text{ MHz}$ ,  $V_{\text{DD}} = 5 \text{ V}$ ,  $T_{\text{A}} = 25^{\circ}\text{C}$ ,  $\lambda_{\text{p}} = 640 \text{ nm}$ ,  $t_{\text{int}} = 5 \text{ ms}$ ,  $R_{\text{L}} = 330 \Omega$ ,  $E_{\text{e}} = 11 \mu\text{W}/\text{cm}^2$  (unless otherwise noted) (see Note 3)**

PARAMETER		TEST CONDITIONS	MIN	TYP	MAX	UNIT
$V_{\text{out}}$	Analog output voltage (white, average over 128 pixels)	See Note 4	1.6	2	2.4	V
$V_{\text{drk}}$	Analog output voltage (dark, average over 128 pixels)	$E_{\text{e}} = 0$	0	0.1	0.2	V
PRNU	Pixel response nonuniformity	See Note 5		±4%	±10%	
	Nonlinearity of analog output voltage	See Note 6		±0.4%		FS
	Output noise voltage	See Note 7		1		mVrms
$R_{\text{e}}$	Responsivity	See Note 8	25	35	45	V/ ( $\mu\text{J}/\text{cm}^2$ )
$V_{\text{sat}}$	Analog output saturation voltage	$V_{\text{DD}} = 5 \text{ V}$ , $R_{\text{L}} = 330 \Omega$	4.5	4.8		V
		$V_{\text{DD}} = 3 \text{ V}$ , $R_{\text{L}} = 330 \Omega$	2.5	2.8		
SE	Saturation exposure	$V_{\text{DD}} = 5 \text{ V}$ , See Note 9		136		nJ/cm <sup>2</sup>
		$V_{\text{DD}} = 3 \text{ V}$ , See Note 9		78		
DSNU	Dark signal nonuniformity	All pixels, $E_{\text{e}} = 0$ , See Note 10		0.02	0.05	V
IL	Image lag	See Note 11		0.5%		
$I_{\text{DD}}$	Supply current	$V_{\text{DD}} = 5 \text{ V}$ , $E_{\text{e}} = 0$		2.8	4.5	mA
		$V_{\text{DD}} = 3 \text{ V}$ , $E_{\text{e}} = 0$		2.6	4.5	
$I_{\text{IH}}$	High-level input current	$V_{\text{I}} = V_{\text{DD}}$			1	$\mu\text{A}$
$I_{\text{IL}}$	Low-level input current	$V_{\text{I}} = 0$			1	$\mu\text{A}$
$C_{\text{i}}$	Input capacitance			5		pF

- NOTES: 3. All measurements made with a 0.1  $\mu\text{F}$  capacitor connected between  $V_{\text{DD}}$  and ground.  
4. The array is uniformly illuminated with a diffused LED source having a peak wavelength of 640 nm.  
5. PRNU is the maximum difference between the voltage from any single pixel and the average output voltage from all pixels of the device under test when the array is uniformly illuminated at the white irradiance level. PRNU includes DSNU.  
6. Nonlinearity is defined as the maximum deviation from a best-fit straight line over the dark-to-white irradiance levels, as a percent of analog output voltage (white).  
7. RMS noise is the standard deviation of a single-pixel output under constant illumination as observed over a 5-second period.  
8.  $R_{\text{e}(\text{min})} = [V_{\text{out}(\text{min})} - V_{\text{drk}(\text{max})}] \div (E_{\text{e}} \times t_{\text{int}})$   
9.  $\text{SE}(\text{min}) = [V_{\text{sat}(\text{min})} - V_{\text{drk}(\text{min})}] \times (E_{\text{e}} \times t_{\text{int}}) \div [V_{\text{out}(\text{max})} - V_{\text{drk}(\text{min})}]$   
10. DSNU is the difference between the maximum and minimum output voltage for all pixels in the absence of illumination.  
11. Image lag is a residual signal left in a pixel from a previous exposure. It is defined as a percent of white-level signal remaining after a pixel is exposed to a white condition followed by a dark condition:

$$\text{IL} = \frac{V_{\text{out(IL)}} - V_{\text{drk}}}{V_{\text{out(white)}} - V_{\text{drk}}} \times 100$$

### Timing Requirements (see Figure 1 and Figure 2)

		MIN	NOM	MAX	UNIT
$t_{\text{su(SI)}}$	Setup time, serial input (see Note 12)	20			ns
$t_{\text{h(SI)}}$	Hold time, serial input (see Note 12 and Note 13)	0			ns
$t_{\text{w}}$	Pulse duration, clock high or low	50			ns
$t_{\text{r}}$ , $t_{\text{f}}$	Input transition (rise and fall) time	0		500	ns
$t_{\text{qt}}$	Pixel charge transfer time	20			$\mu\text{s}$

- NOTES: 12. Input pulses have the following characteristics:  $t_{\text{r}} = 6 \text{ ns}$ ,  $t_{\text{f}} = 6 \text{ ns}$ .  
13. SI must go low before the rising edge of the next clock pulse.

### Dynamic Characteristics over recommended ranges of supply voltage and operating free-air temperature (see Figures 7 and 8)

PARAMETER	TEST CONDITIONS	MIN	TYP	MAX	UNIT
$t_{\text{s}}$	Analog output settling time to $\pm 1\%$		120		ns

PARAMETER MEASUREMENT INFORMATION

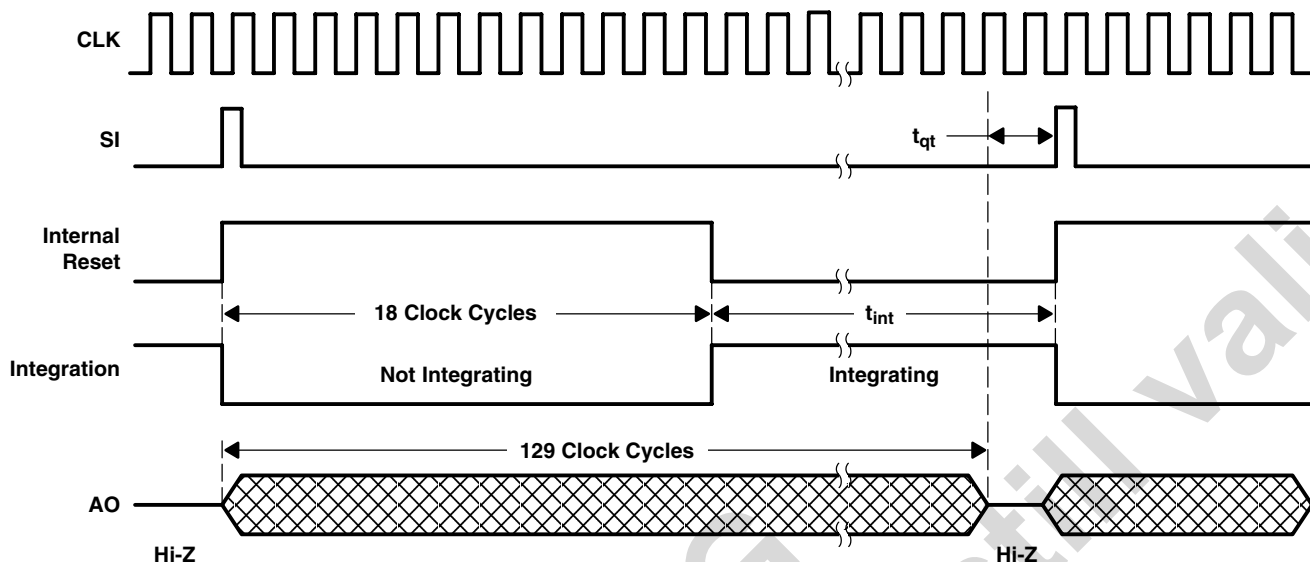

Figure 1. Timing Waveforms

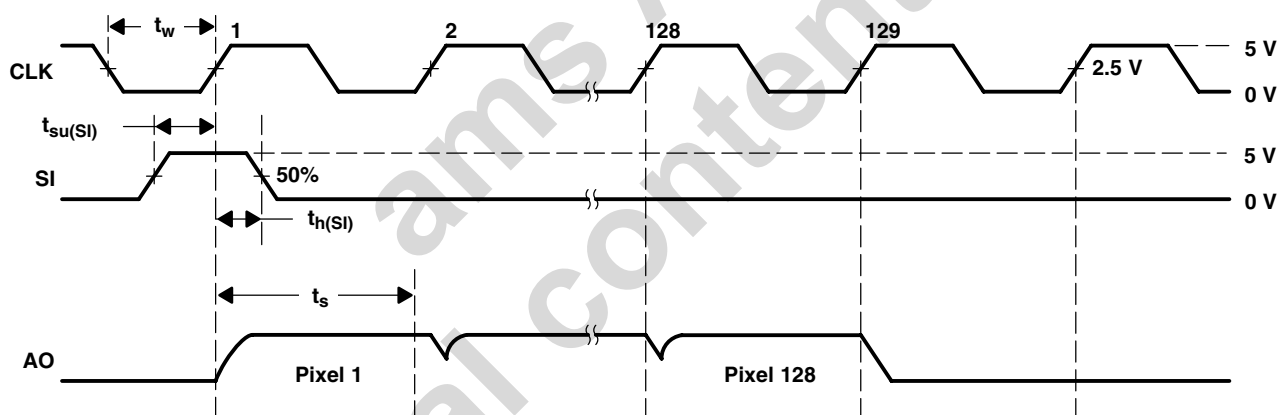

Figure 2. Operational Waveforms

# TSL1401CL

## 128 × 1 LINEAR SENSOR ARRAY WITH HOLD

TAOS136 – JULY 2011

### TYPICAL CHARACTERISTICS

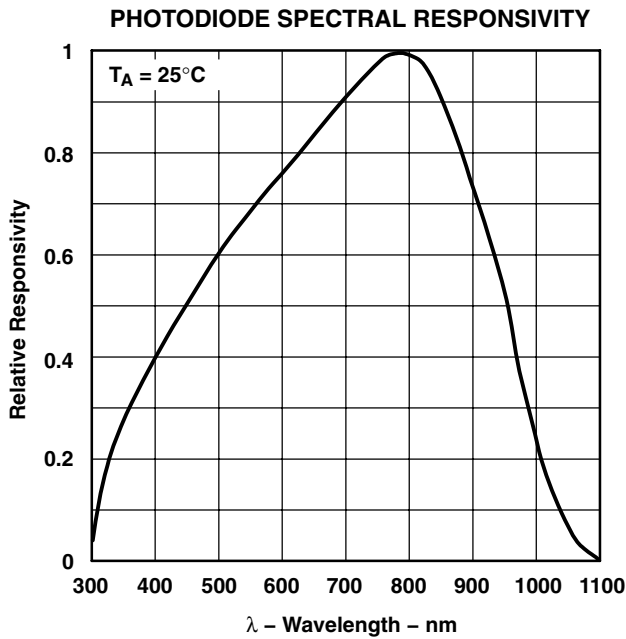

Figure 3

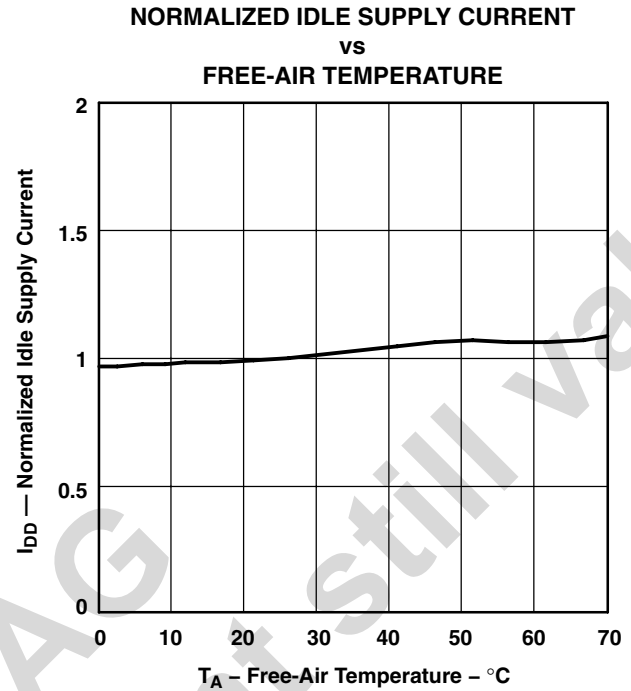

Figure 4

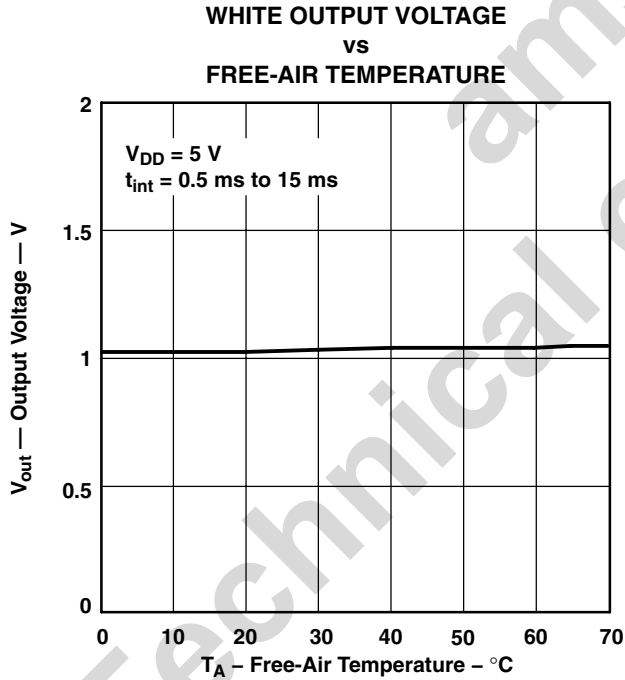

Figure 5

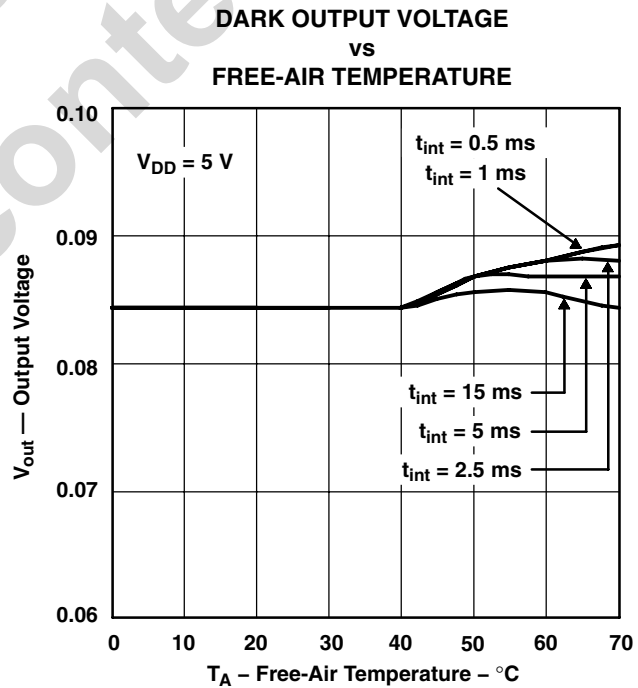
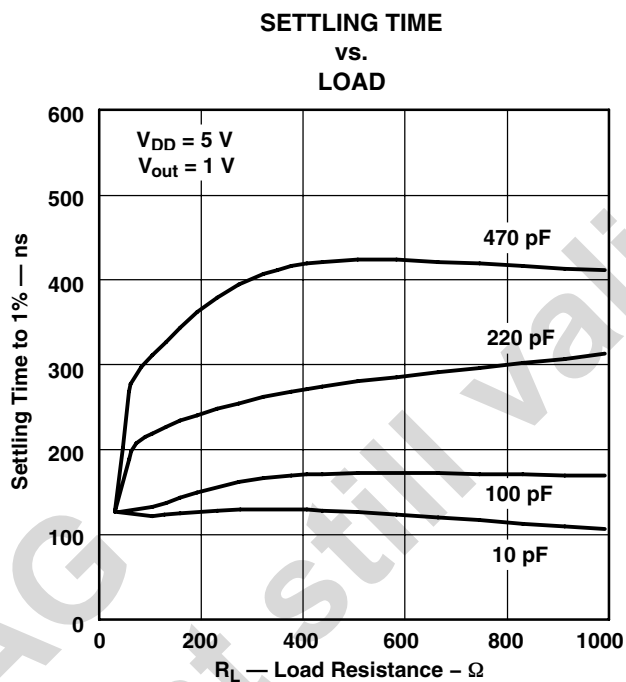
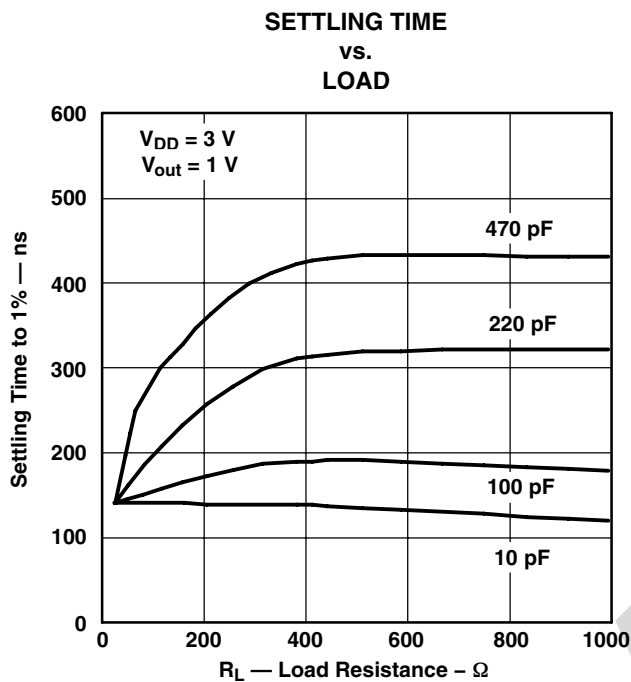

Figure 6

TYPICAL CHARACTERISTICS





# TSL1401CL

## 128 × 1 LINEAR SENSOR ARRAY WITH HOLD

TAOS136 – JULY 2011

### PRINCIPLES OF OPERATION

#### Integration Time

The integration time of the linear array is the period during which light is sampled and charge accumulates on each pixel's integrating capacitor. The flexibility to adjust the integration period is a powerful and useful feature of the TAOS TSL14xx linear array family. By changing the integration time, a desired output voltage can be obtained on the output pin while avoiding saturation for a wide range of light levels.

The integration time is the time between the SI (Start Integration) positive pulse and the HOLD positive pulse minus the 18 setup clocks. The TSL14xx linear array is normally configured with the SI and HOLD pins tied together. This configuration will be assumed unless otherwise noted. Sending a high pulse to SI (observing timing rules for setup and hold to clock edge) starts a new cycle of pixel output and integration setup. However, a minimum of  $(n+1)$  clocks, where  $n$  is the number of pixels, must occur before the next high pulse is applied to SI. It is not necessary to send SI immediately on/after the  $(n+1)$  clocks. A wait time adding up to a maximum total of 100 ms between SI pulses can be added to increase the integration time creating a higher output voltage in low light applications.

Each pixel of the linear array consists of a light-sensitive photodiode. The photodiode converts light intensity to a voltage. The voltage is sampled on the Sampling Capacitor by closing switch S2 (position 1) (see the Functional Block Diagram on page 1). Logic controls the resetting of the Integrating Capacitor to zero by closing switch S1 (position 2).

At SI input, all of the pixel voltages are simultaneously scanned and held by moving S2 to position 2 for all pixels. During this event, S2 for pixel 1 is in position 3. This makes the voltage of pixel 1 available on the analog output. On the next clock, S2 for pixel 1 is put into position 2 and S2 for pixel 2 is put into position 3 so that the voltage of pixel 2 is available on the output.

Following the SI pulse and the next 17 clocks after the SI pulse is applied, the S1 switch for all pixels remains in position 2 to reset (zero out) the integrating capacitor so that it is ready to begin the next integration cycle. On the rising edge of the 19<sup>th</sup> clock, the S1 switch for all the pixels is put into position 1 and all of the pixels begin a new integration cycle.

The first 18 pixel voltages are output during the time the integrating capacitor is being reset. On the 19<sup>th</sup> clock following an SI pulse, pixels 1 through 18 have switch S2 in position 1 so that the sampling capacitor can begin storing charge. For the period from the 19<sup>th</sup> clock through the  $n^{\text{th}}$  clock, S2 is put into position 3 to read the output voltage during the  $n^{\text{th}}$  clock. On the next clock the previous pixel S2 switch is put into position 1 to start sampling the integrating capacitor voltage. For example, S2 for pixel 19 moves to position 1 on the 20<sup>th</sup> clock. On the  $n+1$  clock, the S2 switch for the last ( $n^{\text{th}}$ ) pixel is put into position 1 and the output goes to a high-impedance state.

If a SI was initiated on the  $n+1$  clock, there would be no time for the sampling capacitor of pixel  $n$  to charge to the voltage level of the integrating capacitor. The minimum time needed to guarantee the sampling capacitor for pixel  $n$  will charge to the voltage level of the integrating capacitor is the charge transfer time of 20  $\mu\text{s}$ . Therefore, after  $n+1$  clocks, an extra 20  $\mu\text{s}$  wait must occur before the next SI pulse to start a new integration and output cycle.

The minimum integration time for any given array is determined by time required to clock out all the pixels in the array and the time to discharge the pixels. The time required to discharge the pixels is a constant. Therefore, the minimum integration period is simply a function of the clock frequency and the number of pixels in the array. A slower clock speed increases the minimum integration time and reduces the maximum light level for saturation on the output. The minimum integration time shown in this data sheet is based on the maximum clock frequency of 8 MHz.



### APPLICATION INFORMATION

The minimum integration time can be calculated from the equation:

$$T_{int(min)} = \left( \frac{1}{\text{maximum clock frequency}} \right) \times (n - 18) \text{ pixels} + 20\mu\text{s}$$

where:

$n$  is the number of pixels

In the case of the TSL1401CL with the maximum clock frequency of 8 MHz, the minimum integration time would be:

$$T_{int(min)} = 0.125\mu\text{s} \times (128 - 18) + 20\mu\text{s} = 33.75\mu\text{s}$$

It is good practice on initial power up to run the clock ( $n+1$ ) times after the first SI pulse to clock out indeterminate data from power up. After that, the SI pulse is valid from the time following ( $n+1$ ) clocks. The output will go into a high-impedance state after the  $n+1$  high clock edge. It is good practice to leave the clock in a low state when inactive because the SI pulse required to start a new cycle is a low-to-high transition.

The integration time chosen is valid as long as it falls in the range between the minimum and maximum limits for integration time. If the amount of light incident on the array during a given integration period produces a saturated output (Max Voltage output), then the data is not accurate. If this occurs, the integration period should be reduced until the analog output voltage for each pixel falls below the saturation level. The goal of reducing the period of time the light sampling window is active is to lower the output voltage level to prevent saturation. However, the integration time must still be greater than or equal to the minimum integration period.

If the light intensity produces an output below desired signal levels, the output voltage level can be increased by increasing the integration period provided that the maximum integration time is not exceeded. The maximum integration time is limited by the length of time the integrating capacitors on the pixels can hold their accumulated charge. The maximum integration time should not exceed 100 ms for accurate measurements.

It should be noted that the data from the light sampled during one integration period is made available on the analog output during the next integration period and is clocked out sequentially at a rate of one pixel per clock period. In other words, at any given time, two groups of data are being handled by the linear array: the previous measured light data is clocked out as the next light sample is being integrated.

Although the linear array is capable of running over a wide range of operating frequencies up to a maximum of 8 MHz, the speed of the A/D converter used in the application is likely to be the limiter for the maximum clock frequency. The voltage output is available for the whole period of the clock, so the setup and hold times required for the analog-to-digital conversion must be less than the clock period.

# TSL1401CL

## 128 × 1 LINEAR SENSOR ARRAY WITH HOLD

TAOS136 – JULY 2011

### APPLICATION INFORMATION: HARDWARE

#### PCB Pad Layout

Suggested PCB pad layout guidelines for the CL package are shown in Figure 9.

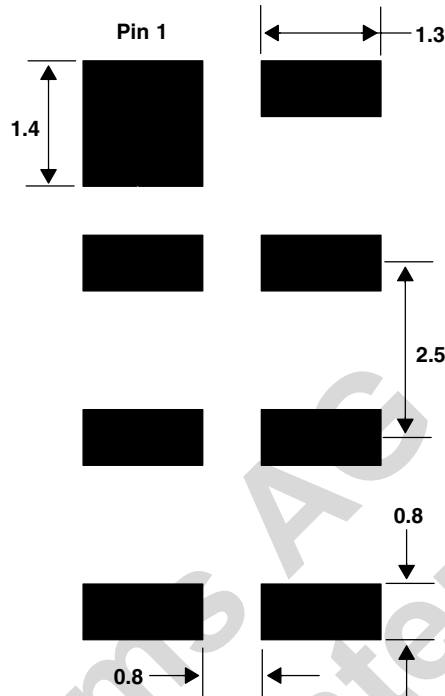

- NOTES: A. All linear dimensions are in millimeters.  
B. This drawing is subject to change without notice.

Figure 9. Suggested CL Package PCB Layout

PACKAGE INFORMATION

TOP VIEW

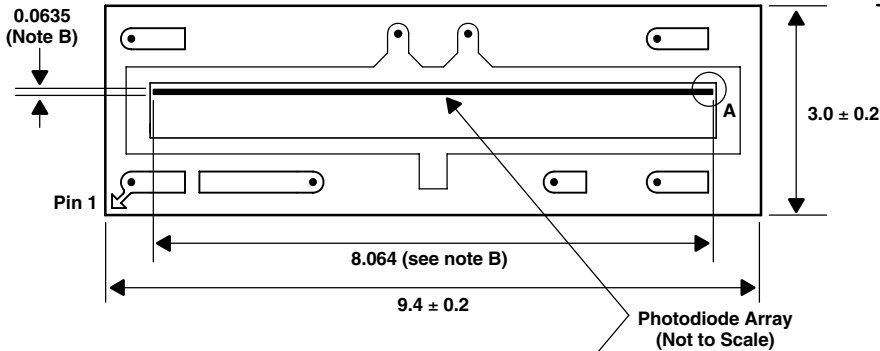

ARRAY DETAIL A  
(Note B)

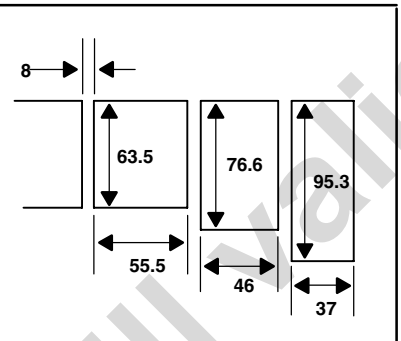

SIDE VIEW

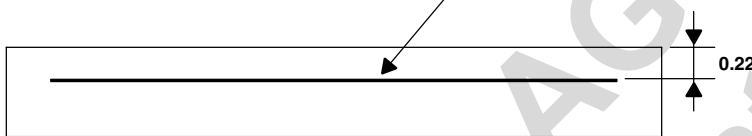

END VIEW

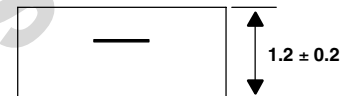

BOTTOM VIEW

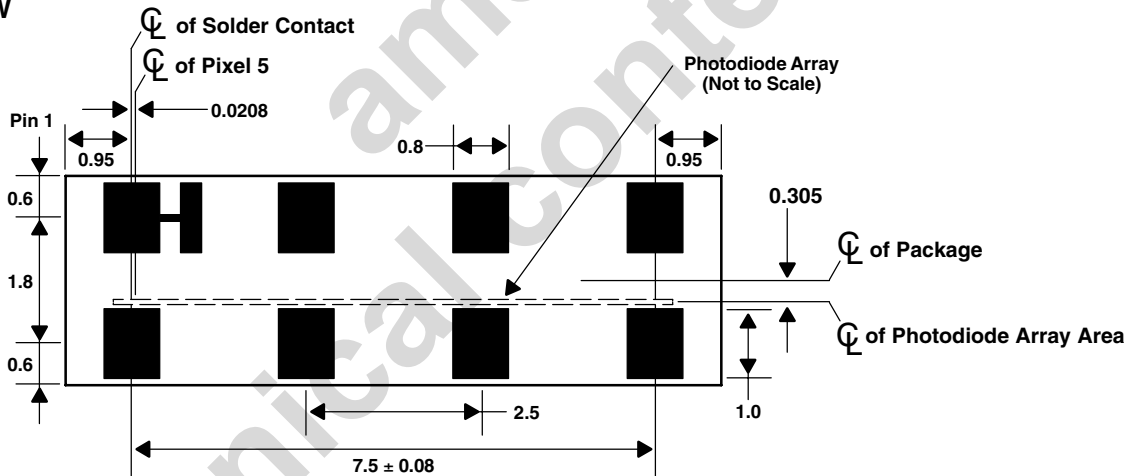

- NOTES: A. All linear dimensions are in millimeters. Dimension tolerance is  $\pm 0.05$  mm unless otherwise noted.  
 B. Nominal photodiode array dimension. The array is made up of 124 inner pixels, 2 next-to-end pixels, and 2 end pixels. Pixel #1 is closer to Pin 1. The inner pixels measure  $63.5 \mu\text{m}$  (H) by  $55.5 \mu\text{m}$  (W), the next-to-end pixels are  $76.6 \mu\text{m}$  (H) by  $46 \mu\text{m}$  (W), and the end pixels are  $95.3 \mu\text{m}$  (H) by  $37 \mu\text{m}$  (W). There is  $8\text{-}\mu\text{m}$  spacing between all pixels. See Array Detail A.  
 C. Package top surface is molded with an electrically nonconductive clear plastic compound having an index of refraction of 1.56.  
 D. Contact finish is soft gold plated.  
 E. This package contains no lead (Pb).  
 F. This drawing is subject to change without notice.

Figure 10. Package CL Configuration

**TSL1401CL**  
**128 × 1 LINEAR SENSOR ARRAY WITH HOLD**

TAOS136 – JULY 2011

**CARRIER TAPE AND REEL INFORMATION**

**TOP VIEW**

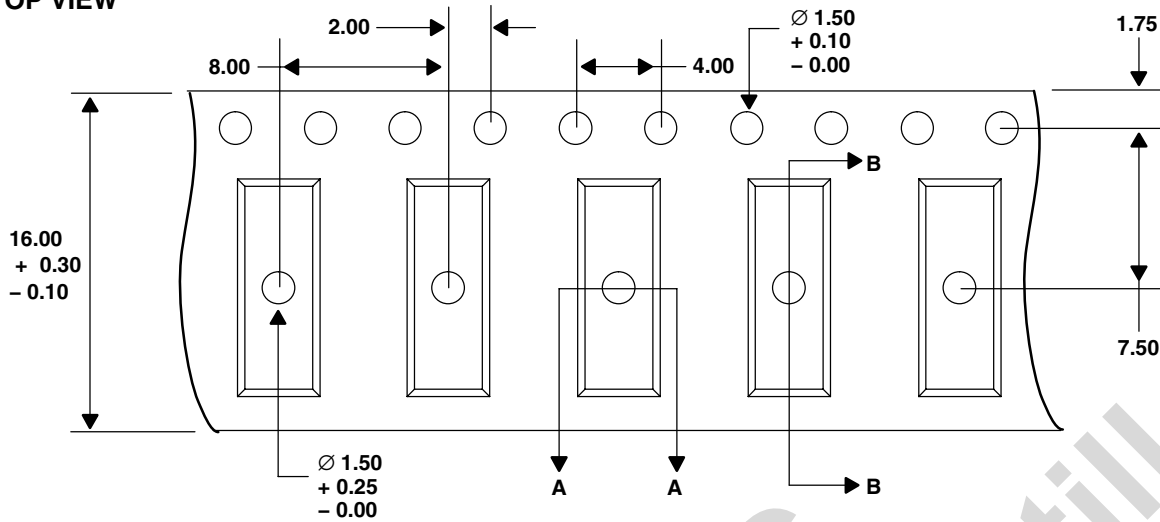

**DETAIL A**

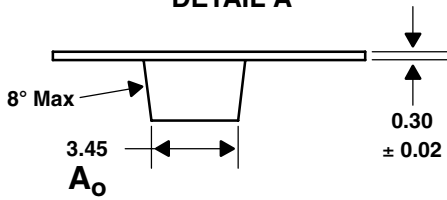

**DETAIL B**

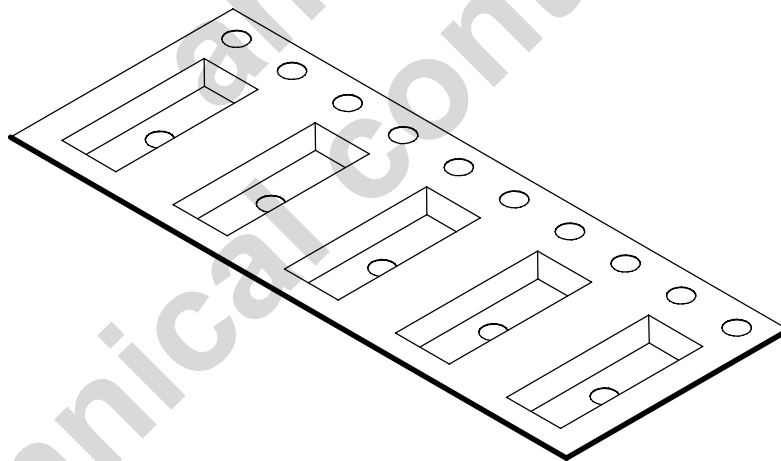
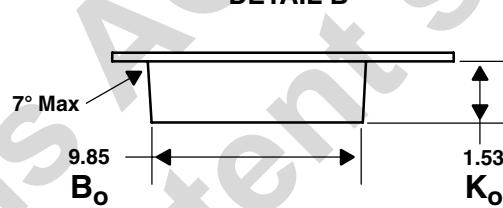

- NOTES: A. All linear dimensions are in millimeters. Dimension tolerance is  $\pm 0.10$  mm unless otherwise noted.  
 B. The dimensions on this drawing are for illustrative purposes only. Dimensions of an actual carrier may vary slightly.  
 C. Symbols on drawing  $A_0$ ,  $B_0$ , and  $K_0$  are defined in ANSI EIA Standard 481-B 2001.  
 D. Each reel is 178 millimeters in diameter and contains 1000 parts.  
 E. TAOS packaging tape and reel conform to the requirements of EIA Standard 481-B.  
 F. In accordance with EIA standard, device pin 1 is located next to the sprocket holes in the tape.  
 G. This drawing is subject to change without notice.

**Figure 11. Package CL Carrier Tape**

### SOLDERING INFORMATION

The CL package has been tested and has demonstrated an ability to be reflow soldered to a PCB substrate.

The solder reflow profile describes the expected maximum heat exposure of components during the solder reflow process of product on a PCB. Temperature is measured on top of component. The components should be limited to a maximum of three passes through this solder reflow profile.

**Table 1. Solder Reflow Profile**

PARAMETER	REFERENCE	DEVICE
Average temperature gradient in preheating		2.5°C/sec
Soak time	$t_{\text{soak}}$	2 to 3 minutes
Time above 217°C (T1)	$t_1$	Max 60 sec
Time above 230°C (T2)	$t_2$	Max 50 sec
Time above $T_{\text{peak}} - 10^\circ\text{C}$ (T3)	$t_3$	Max 10 sec
Peak temperature in reflow	$T_{\text{peak}}$	260°C
Temperature gradient in cooling		Max -5°C/sec

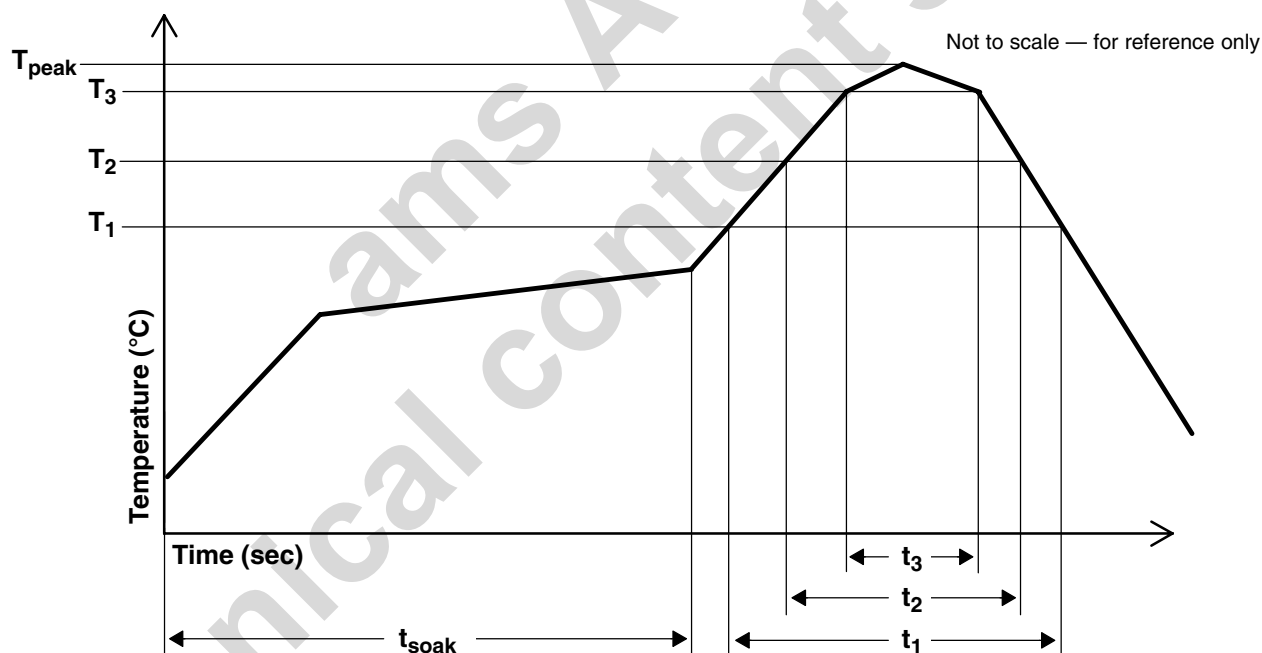

**Figure 12. Solder Reflow Profile Graph**

# TSL1401CL

## 128 × 1 LINEAR SENSOR ARRAY WITH HOLD

TAOS136 – JULY 2011

---

### STORAGE INFORMATION

#### Moisture Sensitivity

Optical characteristics of the device can be adversely affected during the soldering process by the release and vaporization of moisture that has been previously absorbed into the package. To ensure the package contains the smallest amount of absorbed moisture possible, each device is dry-baked prior to being packed for shipping. Devices are packed in a sealed aluminized envelope called a moisture barrier bag with silica gel to protect them from ambient moisture during shipping, handling, and storage before use.

The CL package has been assigned a moisture sensitivity level of MSL 5a and the devices should be stored under the following conditions:

Temperature Range	5°C to 50°C
Relative Humidity	60% maximum
Total Time	6 months from the date code on the aluminized envelope — if unopened
Opened Time	24 hours or fewer

Rebaking will be required if the devices have been stored unopened for more than 6 months or if the aluminized envelope has been open for more than 24 hours. If rebaking is required, it should be done at 60°C for 24 hours.

ams AG  
Technical content still valid

**PRODUCTION DATA** — information in this document is current at publication date. Products conform to specifications in accordance with the terms of Texas Advanced Optoelectronic Solutions, Inc. standard warranty. Production processing does not necessarily include testing of all parameters.

### **LEAD-FREE (Pb-FREE) and GREEN STATEMENT**

**Pb-Free (RoHS)** TAOS' terms *Lead-Free* or *Pb-Free* mean semiconductor products that are compatible with the current RoHS requirements for all 6 substances, including the requirement that lead not exceed 0.1% by weight in homogeneous materials. Where designed to be soldered at high temperatures, TAOS Pb-Free products are suitable for use in specified lead-free processes.

**Green (RoHS & no Sb/Br)** TAOS defines *Green* to mean Pb-Free (RoHS compatible), and free of Bromine (Br) and Antimony (Sb) based flame retardants (Br or Sb do not exceed 0.1% by weight in homogeneous material).

**Important Information and Disclaimer** The information provided in this statement represents TAOS' knowledge and belief as of the date that it is provided. TAOS bases its knowledge and belief on information provided by third parties, and makes no representation or warranty as to the accuracy of such information. Efforts are underway to better integrate information from third parties. TAOS has taken and continues to take reasonable steps to provide representative and accurate information but may not have conducted destructive testing or chemical analysis on incoming materials and chemicals. TAOS and TAOS suppliers consider certain information to be proprietary, and thus CAS numbers and other limited information may not be available for release.

### **NOTICE**

Texas Advanced Optoelectronic Solutions, Inc. (TAOS) reserves the right to make changes to the products contained in this document to improve performance or for any other purpose, or to discontinue them without notice. Customers are advised to contact TAOS to obtain the latest product information before placing orders or designing TAOS products into systems.

TAOS assumes no responsibility for the use of any products or circuits described in this document or customer product design, conveys no license, either expressed or implied, under any patent or other right, and makes no representation that the circuits are free of patent infringement. TAOS further makes no claim as to the suitability of its products for any particular purpose, nor does TAOS assume any liability arising out of the use of any product or circuit, and specifically disclaims any and all liability, including without limitation consequential or incidental damages.

TEXAS ADVANCED OPTOELECTRONIC SOLUTIONS, INC. PRODUCTS ARE NOT DESIGNED OR INTENDED FOR USE IN CRITICAL APPLICATIONS IN WHICH THE FAILURE OR MALFUNCTION OF THE TAOS PRODUCT MAY RESULT IN PERSONAL INJURY OR DEATH. USE OF TAOS PRODUCTS IN LIFE SUPPORT SYSTEMS IS EXPRESSLY UNAUTHORIZED AND ANY SUCH USE BY A CUSTOMER IS COMPLETELY AT THE CUSTOMER'S RISK.

LUMENOLOGY, TAOS, the TAOS logo, and Texas Advanced Optoelectronic Solutions are registered trademarks of Texas Advanced Optoelectronic Solutions Incorporated.



**TSL1401CL**  
**128 × 1 LINEAR SENSOR ARRAY WITH HOLD**

TAOS136 – JULY 2011

---

ams AG  
Technical content still valid