

Applications

- Receive Chain Protection
- Commercial and Military Radar
- Electronic Warfare
- Communications

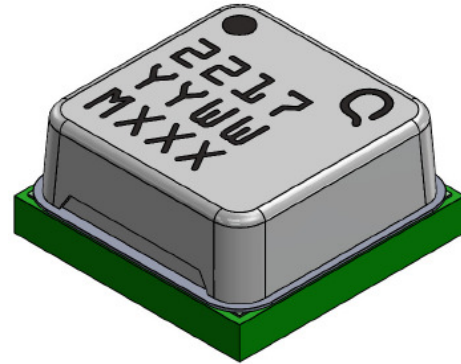

Product Features

- Frequency Range: 0.1 to 20.0 GHz
- Insertion Loss: < 0.9 dB
- Peak Power Handling: 10 W (pulsed)
- Flat Leakage: < 18.5 dBm
- Spike Leakage < 20.5 dBm
- Passive (no DC bias required)
- Recovery time < 115 ns
- QFN Package Dimensions: 3.50 x 3.50 x 1.64 mm

Functional Block Diagram

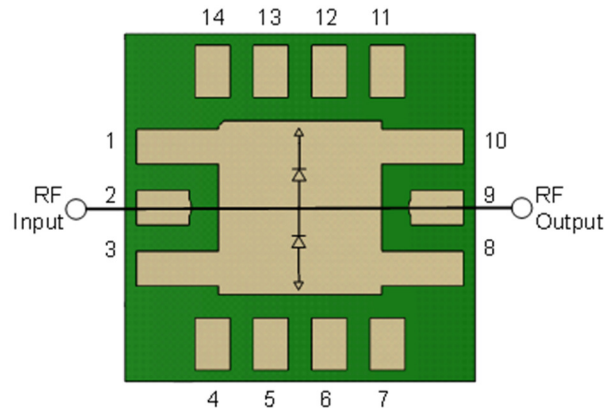

General Description

The TriQuint TGL2217-SM is a packaged high power, wideband GaAs VPIN limiter capable of protecting sensitive receive channel components against high power incident signals. The TGL2217-SM does not require DC bias and achieves a low insertion loss all in a small form factor. These features allow for simple integration with minimal impact to system performance.

The TGL2217-SM operates from 0.1–20.0 GHz with low insertion loss of less than 0.9 dB. Receive protection is rated up to 10 W incident pulsed-power with a low flat leakage of less than 18.5 dBm.

The TGL2217-SM is offered in a small 3.5 x 3.5 mm QFN package for simple board level assembly. Fully matched to 50 ohms on both RF ports, it is well suited for both commercial and defense related applications.

Lead-free and RoHS compliant.

Evaluation boards available on request.

Pad Configuration

Pad Number	Symbol
1, 3, 8, 10, 15	GND
2	RF Input
4–7, 11–14	NC
9	RF Output

NOTE: The RF Input and RF Output ports are not interchangeable.

Ordering Information

Part	ECCN	Description
TGL2217-SM	EAR99	0.1–20.0 GHz 10W VPIN Limiter
TGL2217-SM_EVB	EAR99	0.1–20.0 GHz 10W VPIN Limiter Evaluation Board

Absolute Maximum Ratings

Parameter	Value
Incident Power, Pulsed, 50 Ω, 85 °C	40 dBm
Incident Power, CW, 50 Ω, 25 °C	36 dBm
Incident Power, CW, 50 Ω, 85 °C	33 dBm
Mounting Temperature (30 s max)	260 °C
Storage Temperature	-40 to 150 °C

Operation of this device outside the parameter ranges given above may cause permanent damage. These are stress ratings only, and functional operation of the device at these conditions is not implied.

Recommended Operating Conditions

Parameter	Value
Passive – No bias	

Electrical specifications are measured at specified test conditions. Specifications are not guaranteed over all operating conditions.

Electrical Specifications

Test conditions unless otherwise noted: 25 °C

Parameter	Min	Typical	Max	Units
Operational Frequency Range	0.1		20.0	GHz
Insertion Loss		< 0.9		dB
Input Return Loss		> 13		dB
Output Return Loss		> 13		dB
Flat Leakage Power at P _{IN} > 30 dBm		< 18.5		dBm
Pulse Recovery Time		< 115		ns
Spike Leakage		< 20.5		dBm
Insertion Loss Temperature Coefficient		0.002		dB/ °C

Thermal and Reliability Information

Parameter	Test Conditions	Value	Units
Incident Power ¹ (RF Operational Life Test ²)	10 GHz Pulsed, PW=10 us, DC=10%, 50 Ω, 25 °C	TBD	W

Notes:

1. Testing in work. Similar performance to other Qorvo VPIN Limiters (e.g. TGL2205)
2. Test terminated after TBD hours.p

Typical Performance: Small Signal

Test conditions unless otherwise noted: 25 °C

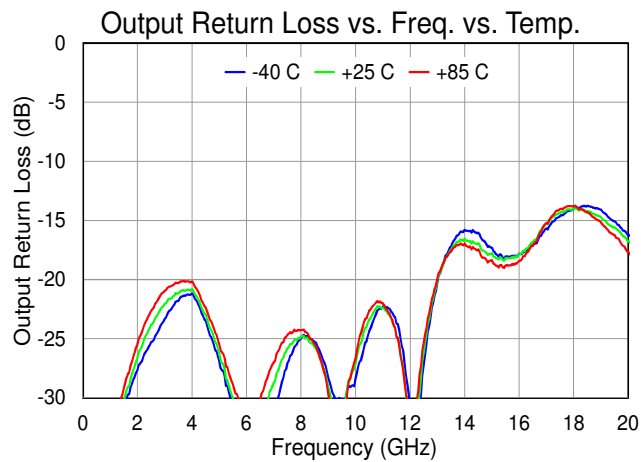
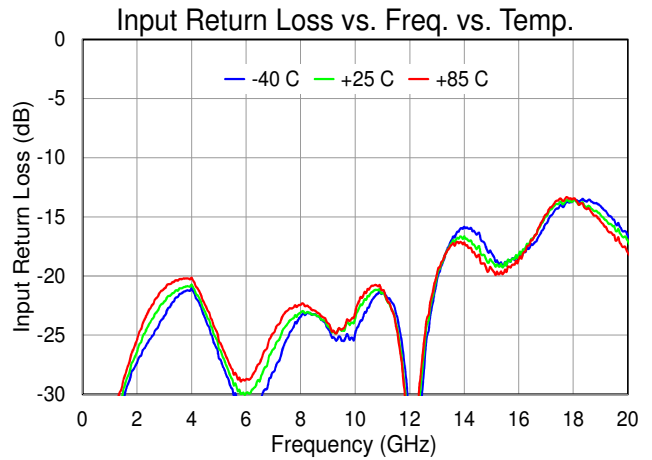
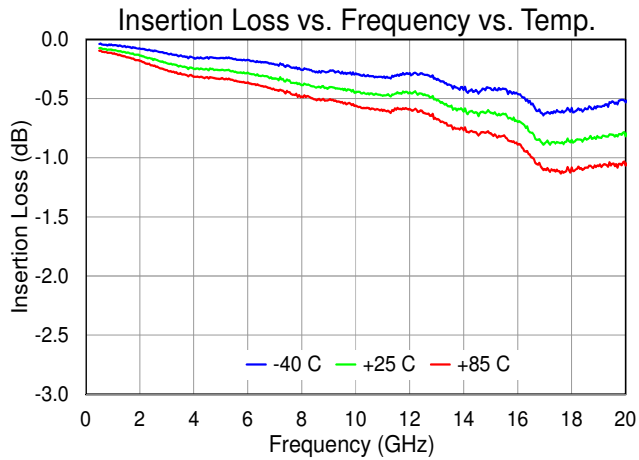

Typical Performance: Large Signal

Test conditions unless otherwise noted: 25 °C

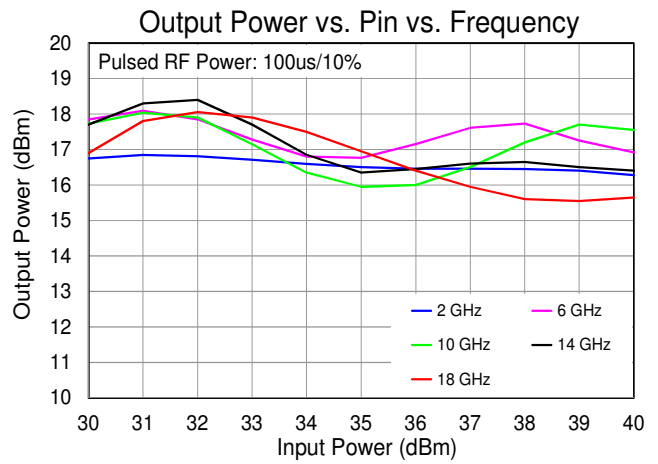
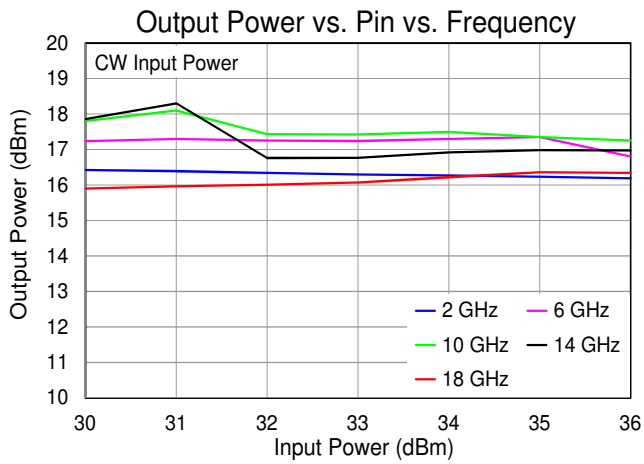
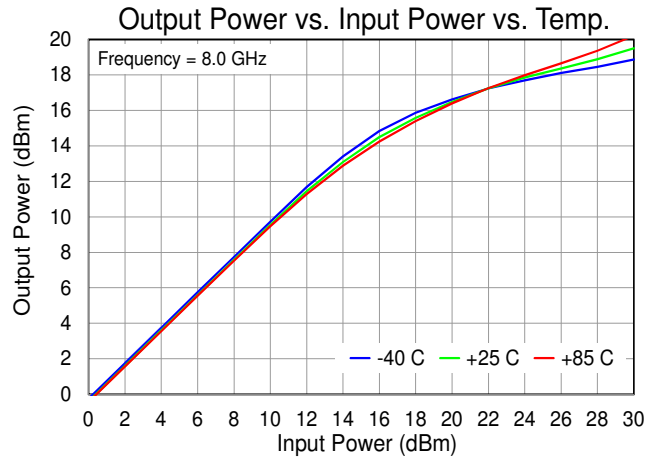
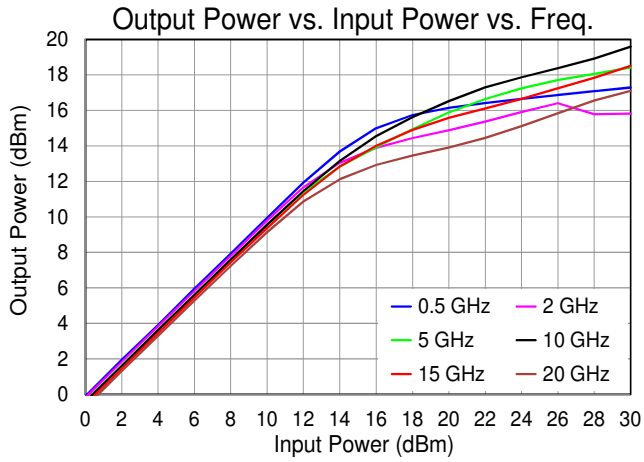

Applications Circuit

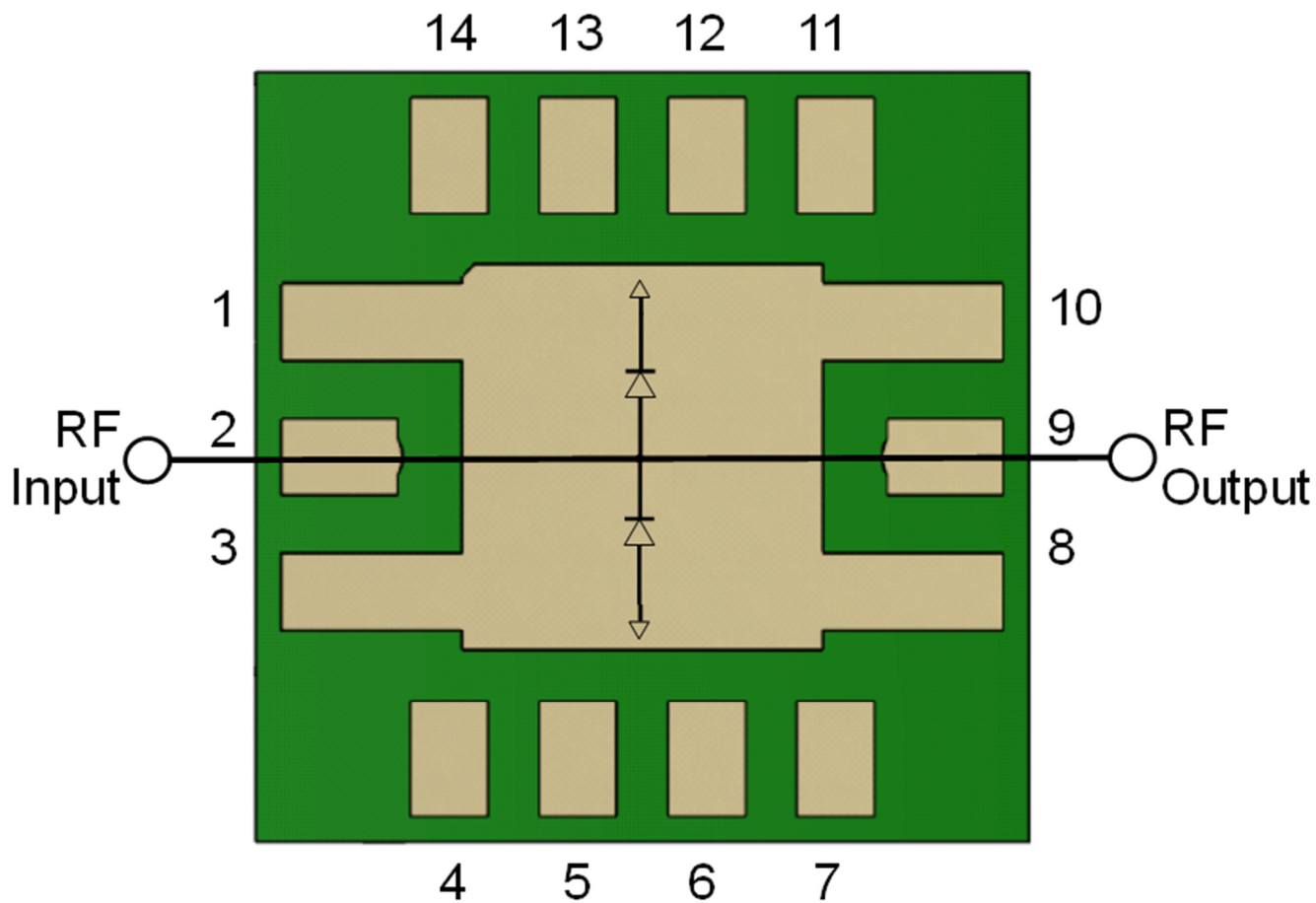

NOTE: The RF Input and RF Output ports are not interchangeable.

Applications Information – Evaluation Board (EVB)

EVB Layout

RF layer is 0.008" thick Rogers RO4003C, $\epsilon_r=3.38$. Metal layers are 0.5-oz copper. The microstrip line taper at the connector interface is optimized for the Southwest Microwave end-launch connector 1092-01A-5.

The pad pattern shown has been developed and tested for optimized assembly at TriQuint Semiconductor. The PCB land pattern has been developed to accommodate lead and package tolerances. Since surface mount processes vary from company to company, careful process development is recommended.

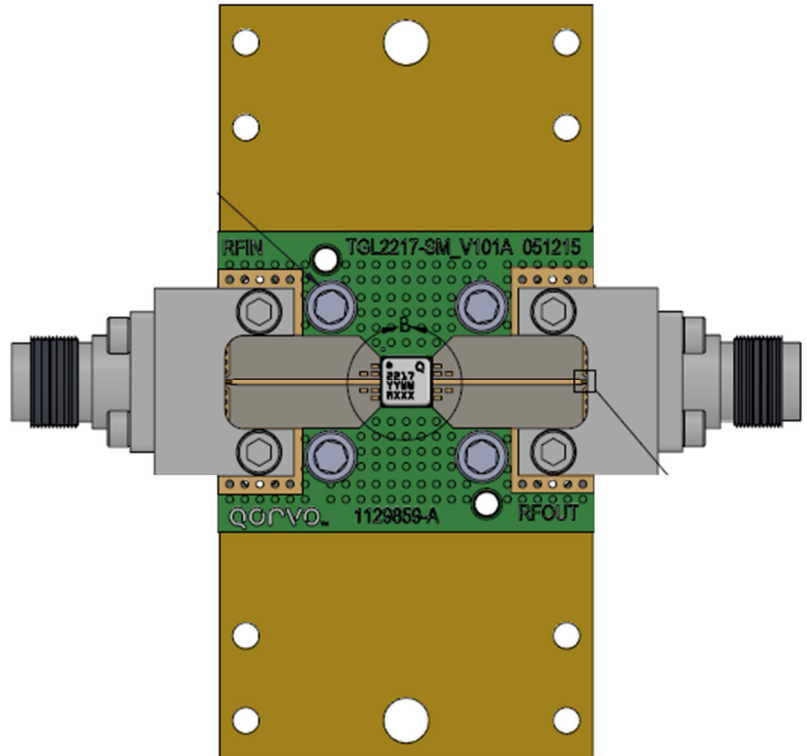

EVB Package Mounting Detail

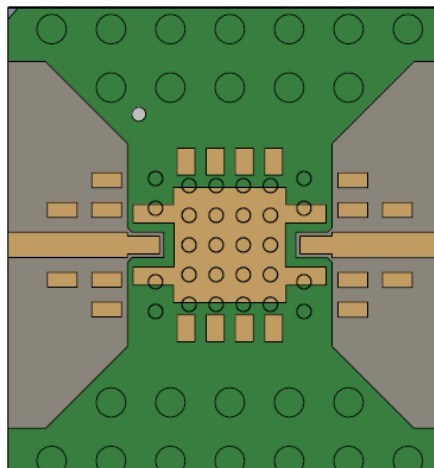

Note:
 Multiple copper-filled vias should be employed under die to minimize inductance and thermal resistance.

Mechanical Drawing and Pad Description

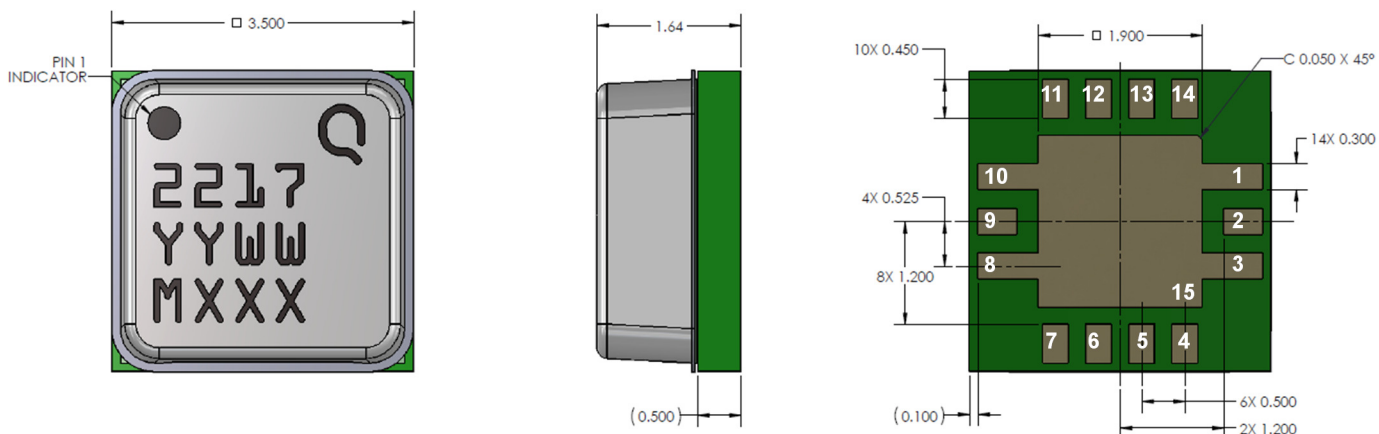

Units: millimeters

Tolerances:

.xx = ± 0.25

.xxx = ± 0.100

PART MARKING:

2217: PART NUMBER

YY: PART ASSY YEAR

WW: PART ASSY WEEK

MXXX: BATCH ID

Package Pad	Symbol	Description
1, 3, 8, 10, 15	GND	On PCB, multiple copper-filled vias should be employed under the center pad (15) to minimize inductance and thermal resistance
2	RF Input	RF Input, matched to 50 Ohms, not DC blocked
4–7, 11–14	NC	No connection; connecting to GND may improve performance
9	RF Output	RF Output, matched to 50 Ohms, not DC blocked

NOTE: The RF Input and RF Output ports are not interchangeable.

Recommended Soldering Temperature Profile

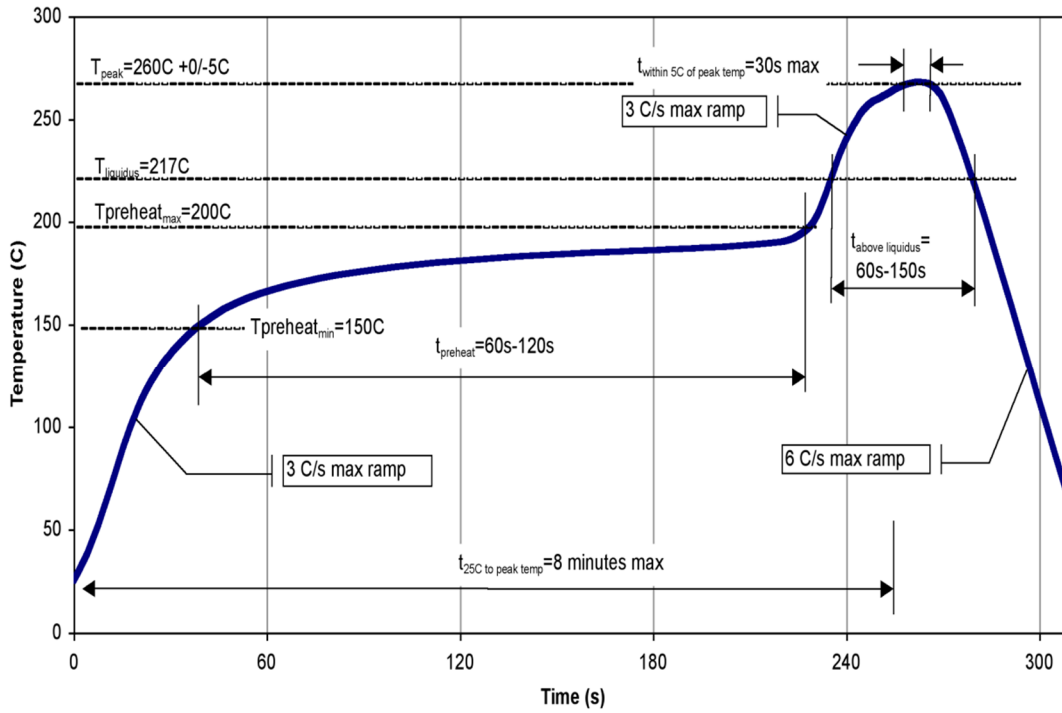

Product Compliance Information

ESD Sensitivity Ratings



Caution! ESD-Sensitive Device

ESD Rating: TBD
Value: TBD
Test: Human Body Model (HBM)
Standard: JEDEC Standard JESD22-A114

MSL Rating

Level TBD at 260 °C convection reflow
This part is rated Moisture Sensitive Level TBD at 260 °C per JEDEC standard IPC/JEDEC J-STD-202

ECCN

US Department of Commerce: EAR99

Solderability

Compatible with both lead-free (260 °C maximum reflow temperature) and tin/lead (245 °C maximum reflow temperature) soldering processes.

RoHS-Compliance

This part is compliant with EU 2002/95/EC RoHS directive (Restrictions on the Use of Certain Hazardous Substances in Electrical and Electronic Equipment).

This product also has the following attributes:

- Lead Free
- Halogen Free (Chlorine, Bromine)
- Antimony Free
- TBBP-A (C15H12Br4O2) Free
- PFOS Free
- SVHC Free

Contact Information

For the latest specifications, additional product information, worldwide sales and distribution locations, and information about TriQuint:

Web: www.triquint.com Tel: +1.972.994.8465
Email: customer.support@qorvo.com

For information about the merger of RFMD and TriQuint as Qorvo:

Web: www.qorvo.com

For technical questions and application information: Email: info-products@tqs.com

Important Notice

The information contained herein is believed to be reliable. TriQuint makes no warranties regarding the information contained herein. TriQuint assumes no responsibility or liability whatsoever for any of the information contained herein. TriQuint assumes no responsibility or liability whatsoever for the use of the information contained herein. The information contained herein is provided "AS IS, WHERE IS" and with all faults, and the entire risk associated with such information is entirely with the user. All information contained herein is subject to change without notice. Customers should obtain and verify the latest relevant information before placing orders for TriQuint products. The information contained herein or any use of such information does not grant, explicitly or implicitly, to any party any patent rights, licenses, or any other intellectual property rights, whether with regard to such information itself or anything described by such information.

TriQuint products are not warranted or authorized for use as critical components in medical, life-saving, or life-sustaining applications, or other applications where a failure would reasonably be expected to cause severe personal injury or death.