

# PCS3P2005A

## Product Preview

# General Purpose Peak EMI Reduction IC

### Description

PCS3P2005A is a versatile, 3.3 V/5 V, 1x spread spectrum frequency modulator designed to reduce electromagnetic interference (EMI) at the clock source, allowing system wide reduction of EMI of down stream clock and data dependent signals. The device allows significant system cost savings by reducing the number of circuit board layers ferrite beads, shielding and other passive components that are traditionally required to pass EMI regulations.

PCS3P2005A modulates the output of a PLL in order to “spread” the bandwidth of a synthesized clock, and more importantly, decreases the peak amplitudes of its harmonics. This results in significantly lower system EMI compared to the typical narrow band signal produced by oscillators and most frequency generators. Lowering EMI by increasing a signal’s bandwidth is called ‘spread spectrum clock generation.’

PCS3P2005A accepts an input from an external reference clock and locks to a 1x modulated clock output. Two logic pins S0 and D\_C enable selecting one of the 4 different frequency deviations. Refer to the *Deviation Selection Table* for more details. Frequency Range Selection pin enables operation in one of the two frequency ranges. PCS3P2005A operates over a supply voltage range of 5 V / 3.3 V. PCS3P2005A is available in 8 Pin TSSOP and SOIC Packages, over Commercial and Industrial temperature range.

### Applications

PCS3P2005A is targeted for use in a broad range of notebook and desktop PCs and consumer electronic applications.

### Features

- 1x, LVC MOS Peak EMI Reduction
- Input Frequency:
  - 10 MHz – 30 MHz @ 3.3 V
  - 30 MHz – 100 MHz @ 5 V
- Output Frequency:
  - 10 MHz – 30 MHz @ 3.3 V
  - 30 MHz – 100 MHz @ 5 V
- Four Different Frequency Deviation Selection
- Selectable Spread Options: Down Spread and Center Spread
- Frequency Range Selection
- Supply Voltage:
  - 5 V  $\pm$  0.5 V
  - 3.3 V  $\pm$  0.3 V
- 8 Pin TSSOP, SOIC Package
- Commercial and Industrial Temperature Range
- These are Pb-Free Devices

This document contains information on a product under development. ON Semiconductor reserves the right to change or discontinue this product without notice.



ON Semiconductor®

<http://onsemi.com>



SOIC-8  
S SUFFIX  
CASE 751BD



TSSOP-8  
T SUFFIX  
CASE 948AL

### PIN CONFIGURATION

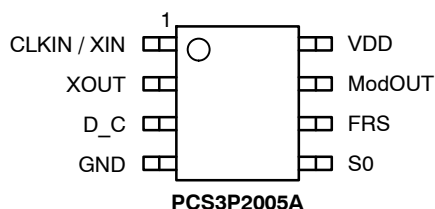

PCS3P2005A

(Top View)

### ORDERING INFORMATION

See detailed ordering and shipping information in the package dimensions section on page 7 of this data sheet.

# PCS3P2005A

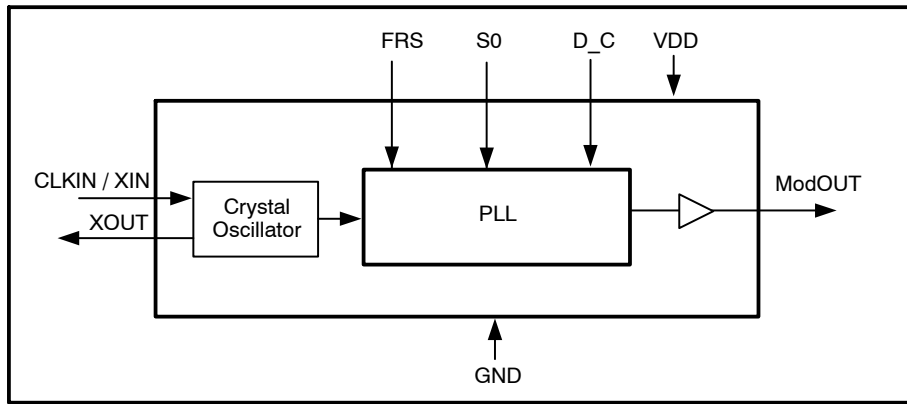

Figure 1. Block Diagram

Table 1. ABSOLUTE MAXIMUM RATINGS

Symbol	Parameter	Rating	Unit
VDD, V <sub>IN</sub>	Voltage on any input pin with respect to Ground	-0.5 to +7.0	V
T <sub>STG</sub>	Storage temperature	-65 to +125	°C
T <sub>s</sub>	Max. Soldering Temperature (10 sec)	260	°C
T <sub>J</sub>	Junction Temperature	150	°C
T <sub>DV</sub>	Static Discharge Voltage (As per JEDEC STD22- A114-B)	2	KV

Stresses exceeding Maximum Ratings may damage the device. Maximum Ratings are stress ratings only. Functional operation above the Recommended Operating Conditions is not implied. Extended exposure to stresses above the Recommended Operating Conditions may affect device reliability.

Table 2. PIN DESCRIPTION

Pin#	Pin Name	Type	Description
1	CLKIN / XIN	I	External reference Clock input or Crystal connection.
2	XOUT	O	Crystal connection. If using an external reference, this pin must be left unconnected.
3	D_C	I	Deviation Selection. Has an internal pull-up resistor. Refer to <i>Deviation Selection Table</i> .
4	GND	P	Ground connection.
5	S0	I	Deviation Selection. Has an internal pull-up resistor. Refer to <i>Deviation Selection Table</i> .
6	FRS	I	Frequency Range Selection. Has an internal pull-up resistor.
7	ModOUT	O	Buffered Modulated Clock Output.
8	VDD	P	Power supply for the entire chip (3.3 V/5 V).

Table 3. FREQUENCY RANGE SELECTION TABLE

FRS	Frequency (MHz)
0	10 – 30
1	30 – 100

Table 4. DEVIATION SELECTION TABLE

Deviation (%)							
D_C	S0	FS = 0			FS = 1		
		10 MHz	20 MHz	30 MHz	30 MHz	80 MHz	100 MHz
0	0	-4.5	-3.6	-1.7	-4.8	-3.6	-2.6
0	1	-2.6	-2	-1	-2.7	-2	-1.5
1	0	±2.6	±2	±1	±2.75	±2	±1.5
1	1	±1.7	±1.25	±0.7	±1.8	±1.25	±1

# PCS3P2005A

**Table 5. OPERATING CONDITIONS**

Symbol	Parameter		Min	Max	Unit
VDD <sub>(5V)</sub>	Supply Voltage		4.5	5.5	V
VDD <sub>(3.3V)</sub>	Supply Voltage		3	3.6	V
T <sub>A</sub>	Operating Temperature	Commercial	0	+70	°C
		Industrial	-40	+85	
C <sub>L</sub>	Load Capacitance			15	pF
C <sub>IN</sub>	Input Capacitance			7	pF

**Table 6. DC ELECTRICAL CHARACTERISTICS FOR VDD = 5 V ± 0.5 V**

Symbol	Parameter		Min	Typ	Max	Unit
VDD	Operating voltage		4.5	5.0	5.5	V
V <sub>IL</sub>	Input low voltage		GND - 0.3		0.8	V
V <sub>IH</sub>	Input high voltage		2.0		VDD + 0.3	V
I <sub>IL</sub>	Input low current				100	μA
I <sub>IH</sub>	Input high current				100	μA
V <sub>OL</sub>	Output low voltage (I <sub>OL</sub> = 12 mA)				0.4	V
V <sub>OH</sub>	Output high voltage (I <sub>OH</sub> = -12 mA)		2.5			V
I <sub>CC</sub>	Static supply current (CLKIN / XIN pulled to GND)				12	mA
I <sub>DD</sub>	Dynamic supply current (Unloaded Output)	FS = 0 (@ 30 MHz)			34	mA
		FS = 1 (@ 100 MHz)			40	
Z <sub>OUT</sub>	Output impedance			30		Ω

**Table 7. AC ELECTRICAL CHARACTERISTICS FOR VDD = 5 V ± 0.5 V**

Symbol	Parameter		Min	Typ	Max	Unit
CLKIN / XIN	Input Clock Frequency	FRS = 0	10		30	MHz
		FRS = 1	30		100	
MODOUT	Output Clock Frequency	FRS = 0	10		30	MHz
		FRS = 1	30		100	
t <sub>LH</sub> (Notes 1, 2)	Output Rise time (measured between 20% to 80%)			1.6	2	nS
t <sub>HL</sub> (Notes 1, 2)	Output Fall time (measured between 80% to 20%)			1.2	1.6	nS
t <sub>D</sub> (Notes 1, 2)	Output duty cycle		45	50	55	%
t <sub>JC</sub> (Note 2)	Jitter (cycle-to-cycle) @ FS = 0, 24 MHz & FS = 1, 80 MHz			±250	±350	pS
t <sub>ON</sub> (Notes 1, 2)	PLL lock time (Stable VDD, valid Clock presented on CLKIN / XIN)				3	mS

1. All parameters are specified with 15 pF loaded output.
2. Parameter is guaranteed by design and characterization. Not 100% tested in production.

# PCS3P2005A

**Table 8. DC ELECTRICAL CHARACTERISTICS FOR VDD = 3.3 V ± 0.3 V**

Symbol	Parameter	Min	Typ	Max	Unit
VDD	Operating voltage	3	3.3	3.6	V
V <sub>IL</sub>	Input low voltage	GND – 0.3		0.8	V
V <sub>IH</sub>	Input high voltage	2.0		VDD + 0.3	V
I <sub>IL</sub>	Input low current			100	μA
I <sub>IH</sub>	Input high current			100	μA
V <sub>OL</sub>	Output low voltage (I <sub>OL</sub> = 12 mA)			0.4	V
V <sub>OH</sub>	Output high voltage (I <sub>OH</sub> = –12 mA)	2.5			V
I <sub>CC</sub>	Static supply current (CLKIN / XIN pulled to GND)			11	mA
I <sub>DD</sub>	Dynamic supply current (Unloaded Output)	FS = 0 (@ 30 MHz)		26	mA
		FS = 1 (@ 100 MHz)		32	
Z <sub>OUT</sub>	Output impedance		40		Ω

**Table 9. AC ELECTRICAL CHARACTERISTICS FOR VDD = 3.3 V ± 0.3 V**

Symbol	Parameter	Min	Typ	Max	Unit	
CLKIN / XIN	Input Clock Frequency	FRS = 0	10		30	MHz
		FRS = 1	30		100	
MODOUT	Output Clock Frequency	FRS = 0	10		30	MHz
		FRS = 1	30		100	
t <sub>LH</sub> (Notes 3, 4)	Output Rise time (measured between 20% to 80%)		1.9	2.5	nS	
t <sub>HL</sub> (Notes 3, 4)	Output Fall time (measured between 80% to 20%)		1.5	2	nS	
t <sub>D</sub> (Notes 3, 4)	Output duty cycle	45	50	55	%	
t <sub>JC</sub> (Note 3)	Jitter (cycle-to-cycle) @ FS = 0, 24 MHz & FS = 1, 80 MHz		±250	±350	pS	
t <sub>ON</sub> (Notes 3, 4)	PLL lock time (Stable VDD, valid Clock presented on CLKIN / XIN)			3	mS	

3. All parameters are specified with 15 pF loaded output.

4. Parameter is guaranteed by design and characterization. Not 100% tested in production.

# PCS3P2005A

## PACKAGE DIMENSIONS

TSSOP8, 4.4x3  
CASE 948AL-01  
ISSUE O

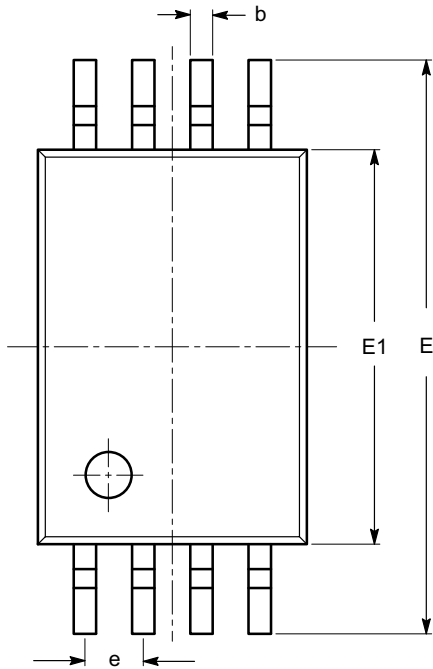

SYMBOL	MIN	NOM	MAX
A			1.20
A1	0.05		0.15
A2	0.80	0.90	1.05
b	0.19		0.30
c	0.09		0.20
D	2.90	3.00	3.10
E	6.30	6.40	6.50
E1	4.30	4.40	4.50
e	0.65 BSC		
L	1.00 REF		
L1	0.50	0.60	0.75
$\theta$	0°		8°

TOP VIEW

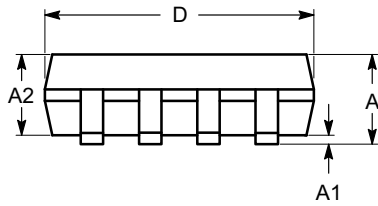

SIDE VIEW

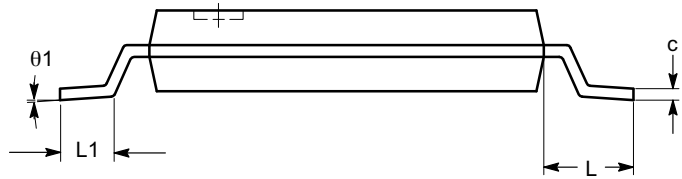

END VIEW

### Notes:

- (1) All dimensions are in millimeters. Angles in degrees.
- (2) Complies with JEDEC MO-153.

# PCS3P2005A

## PACKAGE DIMENSIONS

SOIC 8, 150 mils  
CASE 751BD-01  
ISSUE O

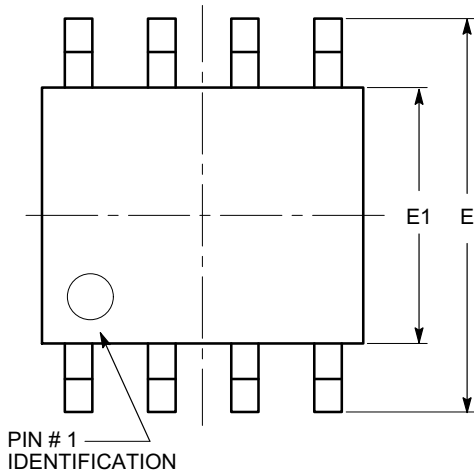

TOP VIEW

SYMBOL	MIN	NOM	MAX
A	1.35		1.75
A1	0.10		0.25
b	0.33		0.51
c	0.19		0.25
D	4.80		5.00
E	5.80		6.20
E1	3.80		4.00
e	1.27 BSC		
h	0.25		0.50
L	0.40		1.27
$\theta$	0°		8°

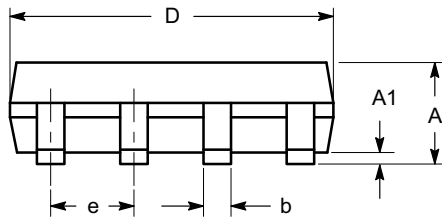

SIDE VIEW

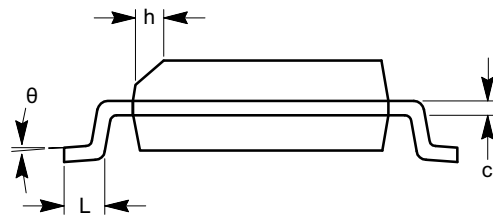

END VIEW

**Notes:**

- (1) All dimensions are in millimeters. Angles in degrees.
- (2) Complies with JEDEC MS-012.

# PCS3P2005A

**Table 10. ORDERING INFORMATION**

Part Number	Marking	Package Type	Temperature
PCS3P2005AG-08SR	3P2005AG	8-PIN SOIC, TAPE AND REEL, Green	Commercial
PCS3P2005AG-08ST	3P2005AG	8-PIN SOIC, TUBE, Green	Commercial
PCS3P2005AG-08TR	3P2005AG	8-PIN TSSOP, TAPE AND REEL, Green	Commercial
PCS3P2005AG-08TT	3P2005AG	8-PIN TSSOP, TUBE, Green	Commercial
PCS3I2005AG-08SR	3I2005AG	8-PIN SOIC, TAPE AND REEL, Green	Industrial
PCS3I2005AG-08ST	3I2005AG	8-PIN SOIC, TUBE, Green	Industrial
PCS3I2005AG-08TR	3I2005AG	8-PIN TSSOP, TAPE AND REEL, Green	Industrial
PCS3I2005AG-08TT	3I2005AG	8-PIN TSSOP, TUBE, Green	Industrial

**ON Semiconductor** and  are registered trademarks of Semiconductor Components Industries, LLC (SCILLC). SCILLC reserves the right to make changes without further notice to any products herein. SCILLC makes no warranty, representation or guarantee regarding the suitability of its products for any particular purpose, nor does SCILLC assume any liability arising out of the application or use of any product or circuit, and specifically disclaims any and all liability, including without limitation special, consequential or incidental damages. "Typical" parameters which may be provided in SCILLC data sheets and/or specifications can and do vary in different applications and actual performance may vary over time. All operating parameters, including "Typicals" must be validated for each customer application by customer's technical experts. SCILLC does not convey any license under its patent rights nor the rights of others. SCILLC products are not designed, intended, or authorized for use as components in systems intended for surgical implant into the body, or other applications intended to support or sustain life, or for any other application in which the failure of the SCILLC product could create a situation where personal injury or death may occur. Should Buyer purchase or use SCILLC products for any such unintended or unauthorized application, Buyer shall indemnify and hold SCILLC and its officers, employees, subsidiaries, affiliates, and distributors harmless against all claims, costs, damages, and expenses, and reasonable attorney fees arising out of, directly or indirectly, any claim of personal injury or death associated with such unintended or unauthorized use, even if such claim alleges that SCILLC was negligent regarding the design or manufacture of the part. SCILLC is an Equal Opportunity/Affirmative Action Employer. This literature is subject to all applicable copyright laws and is not for resale in any manner.

## PUBLICATION ORDERING INFORMATION

### LITERATURE FULFILLMENT:

Literature Distribution Center for ON Semiconductor  
P.O. Box 5163, Denver, Colorado 80217 USA  
**Phone:** 303-675-2175 or 800-344-3860 Toll Free USA/Canada  
**Fax:** 303-675-2176 or 800-344-3867 Toll Free USA/Canada  
**Email:** [orderlit@onsemi.com](mailto:orderlit@onsemi.com)

**N. American Technical Support:** 800-282-9855 Toll Free  
USA/Canada  
**Europe, Middle East and Africa Technical Support:**  
Phone: 421 33 790 2910  
**Japan Customer Focus Center**  
Phone: 81-3-5773-3850

**ON Semiconductor Website:** [www.onsemi.com](http://www.onsemi.com)

**Order Literature:** <http://www.onsemi.com/orderlit>

For additional information, please contact your local Sales Representative