

# Aluminum electrolytic capacitors

Axial-lead and soldering star capacitors

**Series/Type:** B41693, B41793

**Date:** December 2014

### Applications

- Automotive electronics

### Features

- High vibration stability, special design with high vibration stability up to 45 g available upon request
- High operating temperature capability up to 150 °C
- Rated voltage up to 100 V DC
- Low ESR
- High reliability
- High ripple current capability
- Long useful life
- Storage for up to 15 years at a temperature of up to 35 °C.  
If the capacitor is stored for longer than two years, the operating voltage must be applied for one hour to ensure the specified leakage current.
- RoHS-compatible

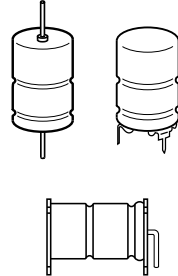

### Construction

- Charge/discharge-proof, polar
- Aluminum case with insulating sleeve
- Negative pole connected to case

### Terminals

- Axial leads, welded to ensure perfect electrical contact
- Soldering star for upright mounting on PCB available
- Alternative axial-lead design with double-sided plates for horizontal mounting available upon request

### Taping and packing

- Axial-lead capacitors will be delivered in pallet package  
Capacitors with  $d \times l \leq 16 \times 30$  mm are also available taped on reel
- Soldering star capacitors are packed in cardboard

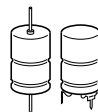
**Specifications and characteristics in brief**

Rated voltage $V_R$	25 ... 100 V DC						
Surge voltage $V_S$	$1.15 \cdot V_R$						
Rated capacitance $C_R$	100 ... 4000 $\mu\text{F}$						
Capacitance tolerance	$-10/+30\% \triangle Q$						
Leakage current $I_{\text{leak}}$ (5 min, 20 °C)	$I_{\text{leak}} \leq 0.006 \mu\text{A} \cdot \left( \frac{C_R}{\mu\text{F}} \cdot \frac{V_R}{\text{V}} \right) + 4 \mu\text{A}$						
Self-inductance ESL <sup>1)</sup>	Diameter d (mm)	12	14	16	18	20/21	
	Terminals	Length l (mm)					Approx. ESL (nH)
	axial	25	–	22	–	30	–
		29	–	–	–	–	38
		30	21	24	29	34	–
		35	–	–	31	–	–
		39	–	–	33	38	45
	soldering star	49	–	–	–	–	50
		25	–	6	–	8	–
		30	6	7	8	10	–
35		–	–	9	–	–	
39		–	–	9	11	13	
49	–	–	–	–	14		
Useful life <sup>2)</sup> 150 °C; $V_R$ ; $0.5 \cdot I_{\text{AC,R}}$ 125 °C; $V_R$ ; $I_{\text{AC,R}}$ 85 °C; $V_R$ ; $I_{\text{AC,max}}$ 40 °C; $V_R$ ; $2.1 \cdot I_{\text{AC,R}}$	> 1000 h	Requirements:					
	> 5000 h	$ \Delta C/C  \leq 30\%$ of initial value					
	> 15000 h	ESR $\leq 3$ times initial specified limit <sup>3)</sup>					
	> 200000 h	$I_{\text{leak}} \leq$ initial specified limit					
Voltage endurance test 125 °C; $V_R$	2000 h	Post test requirements:					
		$ \Delta C/C  \leq 10\%$ of initial value					
		ESR $\leq 1.3$ times of initial specified limit <sup>3)</sup>					
Vibration resistance test	$I_{\text{leak}} \leq$ initial specified limit						
	To IEC 60068-2-6, test Fc: Frequency range 10 Hz ... 2 kHz, displacement amplitude max. 1.5 mm, acceleration max. 20 g, duration 3 × 2 h. Capacitor mounted by its wire leads at a distance of (6 ± 1) mm from the case and additionally clamped by the case.						
IEC climatic category	To IEC 60068-1: 55/125/56 (–55 °C/+125 °C/56 days damp heat test)						
Detail specification	Similar to CECC 30301-802						
Sectional specification	IEC 60384-4						

1) If optimum circuit design is used, the values are lower by 30%.

2) Refer to chapter "General technical information, 5 Useful life" on how to interpret useful life.

3) ESR<sub>max</sub> at 100 Hz, 20 °C



**B41693, B41793**

**High reliability – up to 150 °C**

**B41693, Axial-lead capacitors**

**Dimensional drawing**

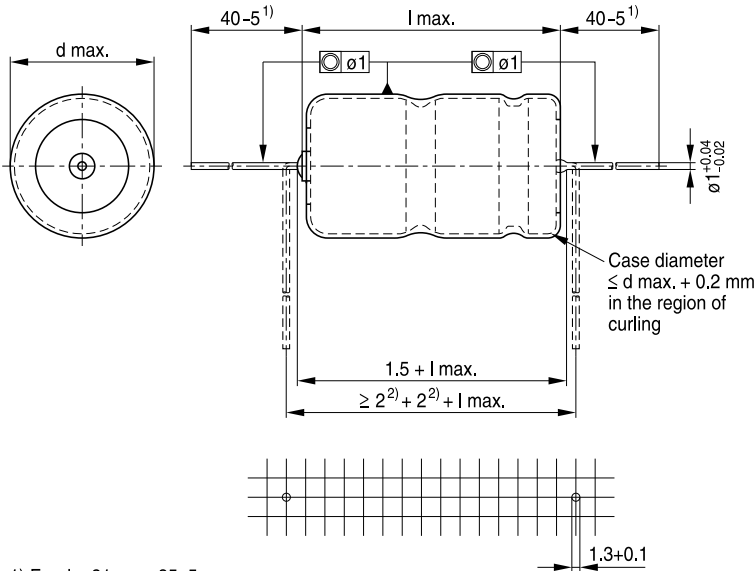

1) For  $d = 21 \text{ mm}$ : 35-5

2) Minimum 2 mm bending distance per wire recommended

KAL1552-3-E

**Dimensions, weights and packing units**

$d \times l$ mm	$d_{\max} \times l_{\max}$ mm	Approx. weight g	Packing units (pcs.)	
			Pallet	Reel
12 × 30	12.5 × 30.5	5.1	288	450
14 × 25	14.5 × 25.5	5.7	200	350
14 × 30	14.5 × 30.5	6.8	200	350
16 × 30	16.5 × 30.5	8.9	180	250
16 × 35	16.5 × 35.5	10.4	180	—
16 × 39	16.5 × 40	11.7	180	—
18 × 25	18.5 × 25.5	9.3	160	—
18 × 30	18.5 × 30.5	11.1	160	—
18 × 39	18.5 × 40	14.7	160	—
20 × 29	20.5 × 29.5	13.5	140	—
21 × 39	21.5 × 40	20.0	140	—
21 × 49	21.5 × 50	25.0	110	—

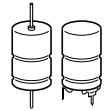
**B41793, Soldering star capacitors**
**Dimensional drawings**

 Mounting holes  $d = 12 \text{ mm} \dots 14 \text{ mm}$ 

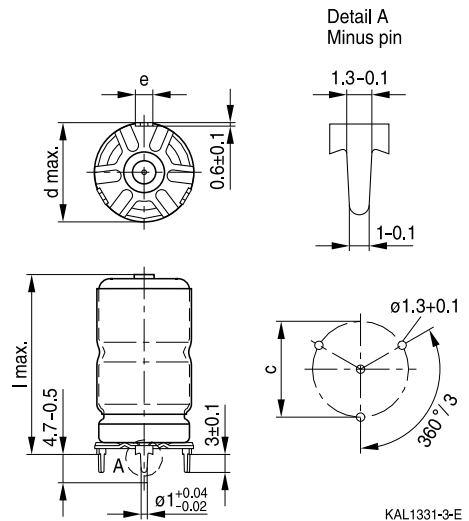
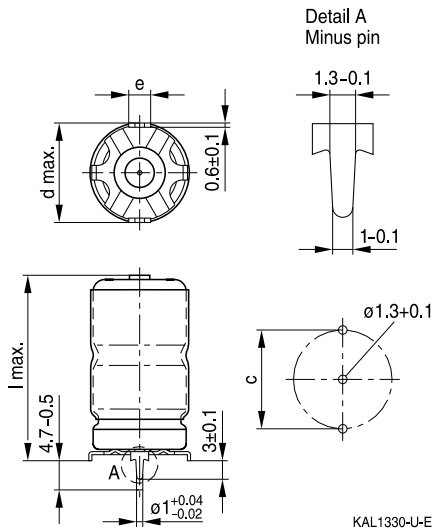
 Mounting holes  $d = 16 \text{ mm} \dots 21 \text{ mm}$ 

**Dimensions, weights and packing units**

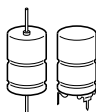
$d \times l$ mm	$d_{\max} \times l_{\max}$ mm	$c \pm 0.1$ mm	$e \pm 0.1$ mm	Approx. weight g	Packing units pcs.
12 × 30	13.5 × 32	12.5	3.0	5.4	480
14 × 25	15.5 × 27	14.5	3.0	6.1	480
14 × 30	15.5 × 32	14.5	3.0	7.2	480
16 × 30	17.5 × 32	16.5	3.0	9.4	300
16 × 35	17.5 × 37	16.5	3.0	10.9	200
16 × 39	17.5 × 41.5	16.5	3.0	12.2	200
18 × 25	19.5 × 27	18.5	3.0	9.9	300
18 × 30	19.5 × 32	18.5	3.0	11.8	300
18 × 39	19.5 × 41.5	18.5	3.0	15.4	200
21 × 39	22.5 × 41.5	21.5	3.5	21.0	324
21 × 49	22.5 × 51.5	21.5	3.5	26.0	264

**B41693, B41793**
**High reliability – up to 150 °C**
**Overview of available types**

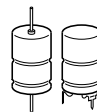
$V_R$ (V DC)	25	40	63	75	100
	Case dimensions $d \times l$ (mm)				
$C_R$ ( $\mu\text{F}$ )					
100			12 × 30	12 × 30	12 × 30
150					14 × 30
220			14 × 30	16 × 30	16 × 30
330		12 × 30	16 × 30 18 × 25	16 × 35	
470	14 × 25	14 × 30	16 × 39	18 × 39 20 × 29	18 × 39 20 × 29
560			20 × 29		
680		16 × 30 18 × 25	18 × 39	21 × 39	21 × 39
820		16 × 35			
1000	16 × 30 18 × 25	16 × 39 18 × 30	21 × 39	21 × 49	21 × 49
1200		20 × 29	21 × 49		
1500	16 × 39	18 × 39			
1800	20 × 29				
2000	18 × 39				
2200		21 × 39			
2700		21 × 49			
3000	21 × 39				
4000	21 × 49				

**Case dimensions and ordering codes**

$V_R$	$C_R$	Case dimensions $d \times l$ mm	Ordering code Axial pallet	Ordering code Axial reel	Ordering code Soldering star	
25	100 Hz	14 × 25	B41693A5477Q001	B41693A5477Q003	B41793A5477Q001	
	20 °C	16 × 30	B41693A5108Q001	B41693A5108Q003	B41793A5108Q001	
	V DC	1000	18 × 25	B41693B5108Q001		B41793B5108Q001
		1500	16 × 39	B41693A5158Q001		B41793A5158Q001
		1800	20 × 29	B41693A5188Q001		
		2000	18 × 39	B41693A5208Q001		B41793A5208Q001
		3000	21 × 39	B41693A5308Q001		B41793A5308Q001
		4000	21 × 49	B41693A5408Q001		B41793A5408Q001
40	330	12 × 30	B41693A7337Q001	B41693A7337Q003	B41793A7337Q001	
	470	14 × 30	B41693A7477Q001	B41693A7477Q003	B41793A7477Q001	
	680	16 × 30	B41693A7687Q001	B41693A7687Q003	B41793A7687Q001	
	680	18 × 25	B41693B7687Q001		B41793B7687Q001	
	820	16 × 35	B41693A7827Q001		B41793A7827Q001	
	1000	16 × 39	B41693B7108Q001		B41793B7108Q001	
	1000	18 × 30	B41693A7108Q001		B41793A7108Q001	
	1200	20 × 29	B41693A7128Q001			
	1500	18 × 39	B41693A7158Q001		B41793A7158Q001	
	2200	21 × 39	B41693A7228Q001		B41793A7228Q001	
	2700	21 × 49	B41693A7278Q001		B41793A7278Q001	
	63	100	12 × 30	B41693A8107Q001	B41693A8107Q003	B41793A8107Q001
		220	14 × 30	B41693A8227Q001	B41693A8227Q003	B41793A8227Q001
330		16 × 30	B41693A8337Q001	B41693A8337Q003	B41793A8337Q001	
330		18 × 25	B41693B8337Q001		B41793B8337Q001	
470		16 × 39	B41693A8477Q001		B41793A8477Q001	
560		20 × 29	B41693A8567Q001			
680		18 × 39	B41693A8687Q001		B41793A8687Q001	
1000		21 × 39	B41693A8108Q001		B41793A8108Q001	
1200		21 × 49	B41693A8128Q001		B41793A8128Q001	

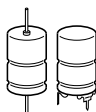

**B41693, B41793**

**High reliability – up to 150 °C**

**Case dimensions and ordering codes**

$V_R$	$C_R$	Case dimensions	Ordering code	Ordering code	Ordering code
	100 Hz	$d \times l$	Axial pallet	Axial reel	Soldering star
	20 °C	mm			
$V_{DC}$	$\mu F$				
75	100	12 × 30	B41693C0107Q001	B41693C0107Q003	B41793C0107Q001
	220	16 × 30	B41693C0227Q001	B41693C0227Q003	B41793C0227Q001
	330	16 × 35	B41693C0337Q001		B41793C0337Q001
	470	18 × 39	B41693C0477Q001		B41793C0477Q001
	470	20 × 29	B41693D0477Q001		
	680	21 × 39	B41693C0687Q001		B41793C0687Q001
	1000	21 × 49	B41693C0108Q001		B41793C0108Q001
100	100	12 × 30	B41693B9107Q001	B41693B9107Q003	B41793B9107Q001
	150	14 × 30	B41693B9157Q001	B41693B9157Q003	B41793B9157Q001
	220	16 × 30	B41693A9227Q001	B41693A9227Q003	B41793A9227Q001
	470	18 × 39	B41693A9477Q001		B41793A9477Q001
	470	20 × 29	B41693B9477Q001		
	680	21 × 39	B41693A9687Q001		B41793A9687Q001
	1000	21 × 49	B41693A9108Q001		B41793A9108Q001

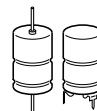

**Technical data**

$C_R$	Case dimensions	$ESR_{max}$ 100 Hz 20 °C μF	$ESR_{max}$ 100 Hz -40 °C mΩ	$ESR_{max}$ 10 kHz 20 °C mΩ	$Z_{max}$ 100 kHz 20 °C mΩ	$I_{AC,max}$ 10 kHz 105 °C A	$I_{AC,max}$ 10 kHz 125 °C A	$I_{AC,R}$ 10 kHz 125 °C A	$I_{AC,max}$ 10 kHz 150 °C A
<b><math>V_R = 25</math> V DC</b>									
470	14 × 25	260	1900	140	102	3.6	2.8	1.95	1.0
1000	16 × 30	130	900	75	55	5.3	4.2	2.9	1.4
1000	18 × 25	120	900	70	50	5.8	4.6	3.15	1.6
1500	16 × 39	85	600	50	39	7.4	5.8	4.0	2.0
1800	20 × 29	70	600	40	30	8.2	6.4	4.45	2.2
2000	18 × 39	70	500	42	26	7.9	6.2	4.3	4.1
3000	21 × 39	43	450	25	21	11.8	9.2	6.4	3.2
4000	21 × 49	33	320	20	16	14.9	11.7	8.0	4.0
<b><math>V_R = 40</math> V DC</b>									
330	12 × 30	320	2500	150	140	3.7	2.9	2.0	1.0
470	14 × 30	220	1700	110	102	4.5	3.5	2.45	1.2
680	16 × 30	160	1200	80	75	5.2	4.1	2.85	1.4
680	18 × 25	150	1200	75	70	5.6	4.4	3.05	1.5
820	16 × 35	130	900	69	65	6.2	4.9	3.4	1.7
1000	16 × 39	110	700	57	55	7.2	5.7	3.9	1.9
1000	18 × 30	115	700	65	62	5.7	4.5	3.1	1.5
1200	20 × 29	85	600	45	44	8.0	6.3	4.35	2.2
1500	18 × 39	75	500	45	43	7.9	6.2	4.3	2.1
2200	21 × 39	50	450	26	26	11.7	9.2	6.3	6.1
2700	21 × 49	40	330	21	21	14.7	11.5	7.9	3.9
<b><math>V_R = 63</math> V DC</b>									
100	12 × 30	700	3300	230	215	3.2	2.5	1.7	0.85
220	14 × 30	320	1700	110	102	4.6	3.6	2.5	1.25
330	16 × 30	220	1200	80	75	5.3	4.2	2.9	1.45
330	18 × 25	210	1200	74	70	5.9	4.6	3.2	1.6
470	16 × 39	150	900	55	52	7.3	5.7	4.0	2.0
560	20 × 29	120	630	45	44	8.1	6.4	4.4	2.2
680	18 × 39	110	550	45	44	7.9	6.2	4.3	2.1
1000	21 × 39	70	440	27	27	11.8	9.2	6.4	3.2
1200	21 × 49	58	380	22	22	14.7	11.5	8.0	4.0

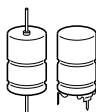

**B41693, B41793**
**High reliability – up to 150 °C**
**Technical data**

$C_R$ 100 Hz 20 °C $\mu\text{F}$	Case dimensions $d \times l$ mm	$\text{ESR}_{\text{max}}$ 100 Hz 20 °C m $\Omega$	$\text{ESR}_{\text{max}}$ 100 Hz -40 °C m $\Omega$	$\text{ESR}_{\text{max}}$ 10 kHz 20 °C m $\Omega$	$Z_{\text{max}}$ 100 kHz 20 °C m $\Omega$	$I_{\text{AC,max}}$ 10 kHz 105 °C A	$I_{\text{AC,max}}$ 10 kHz 125 °C A	$I_{\text{AC,R}}$ 10 kHz 125 °C A	$I_{\text{AC,max}}$ 10 kHz 150 °C A
<b><math>V_R = 75 \text{ V DC}</math></b>									
100	12 × 30	600	3000	200	190	3.5	2.7	1.85	0.9
220	16 × 30	300	1500	100	95	5.1	4.0	2.8	1.4
330	16 × 35	210	1050	75	72	6.3	5.0	3.4	1.7
470	18 × 39	140	700	50	48	7.9	6.2	4.3	2.1
470	20 × 29	135	720	45	44	8.2	6.4	4.4	2.2
680	21 × 39	95	500	30	30	11.5	9.0	6.2	3.1
1000	21 × 49	65	350	22	22	14.8	11.6	8.0	4.0
<b><math>V_R = 100 \text{ V DC}</math></b>									
100	12 × 30	750	4000	320	310	2.3	1.8	1.3	0.6
150	14 × 30	550	2900	230	225	3.0	2.4	1.7	0.8
220	16 × 30	350	1900	160	157	3.7	2.9	2.0	1.0
470	18 × 39	170	900	75	73	6.9	5.4	3.7	1.8
470	20 × 29	175	900	78	76	6.0	4.7	3.2	1.6
680	21 × 39	120	670	58	56	8.5	6.7	4.6	2.3
1000	21 × 49	85	500	44	43	11.2	8.8	6.1	3.0

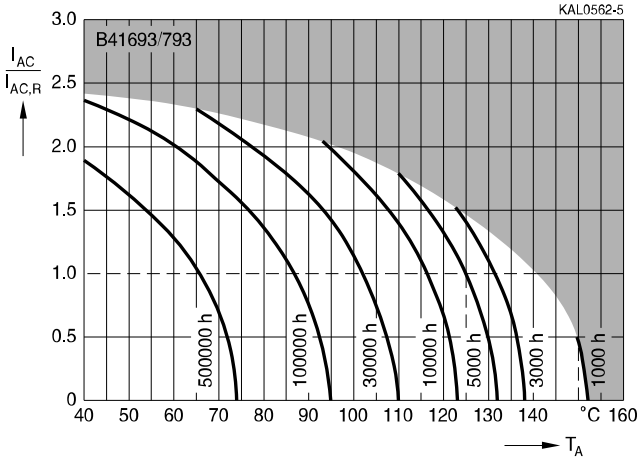

**Useful life<sup>1)</sup>**

depending on ambient temperature  $T_A$  under ripple current operating conditions at  $V_R$



**Useful life<sup>1)</sup>**

depending on case temperature  $T_C$  under ripple current operating conditions at  $V_R$

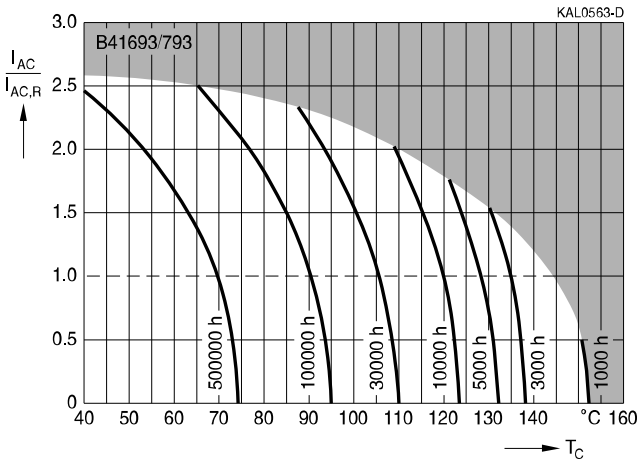

1) Refer to chapter "General technical information, 5 Useful life" on how to interpret useful life.



**B41693, B41793**

**High reliability – up to 150 °C**

**Frequency factor of permissible ripple current  $I_{AC}$  versus frequency  $f$**

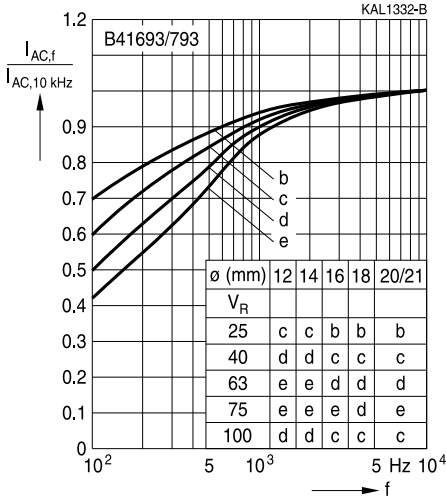

**Frequency characteristics of ESR**  
Typical behavior

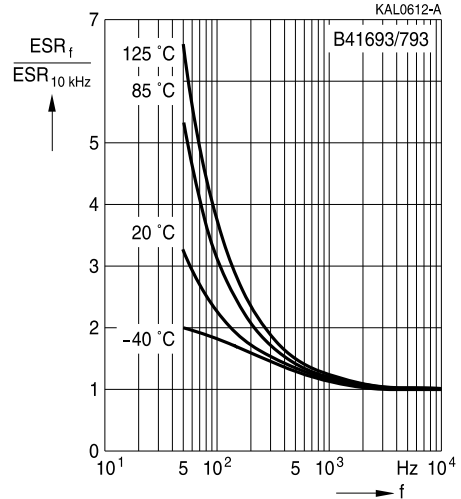

**Equivalent series resistance ESR versus frequency  $f$**

Typical behavior for 470  $\mu$ F/63V

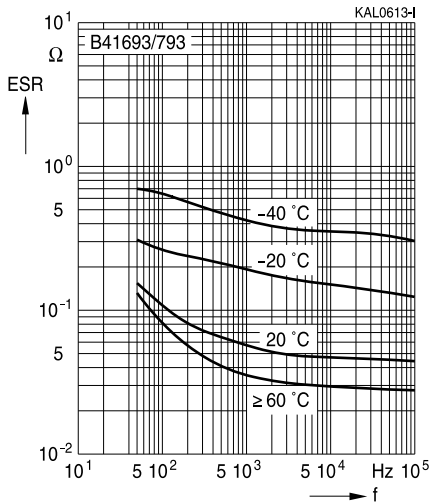

**Impedance  $Z$  versus frequency  $f$**

Typical behavior for 470  $\mu$ F/63V

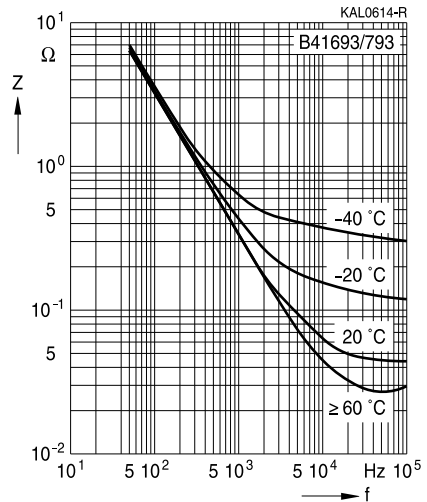



## Cautions and warnings

### Personal safety

The electrolytes used by EPCOS have been optimized both with a view to the intended application and with regard to health and environmental compatibility. They do not contain any solvents that are detrimental to health, e.g. dimethyl formamide (DMF) or dimethyl acetamide (DMAC).

Furthermore, some of the high-voltage electrolytes used by EPCOS are self-extinguishing.

As far as possible, EPCOS does not use any dangerous chemicals or compounds to produce operating electrolytes. However, in exceptional cases, such materials must be used in order to achieve specific physical and electrical properties because no alternative materials are currently known. However, the amount of dangerous materials used in our products is limited to an absolute minimum.

Materials and chemicals used in EPCOS aluminum electrolytic capacitors are continuously adapted in compliance with the EPCOS Corporate Environmental Policy and the latest EU regulations and guidelines such as RoHS, REACH/SVHC, GADSL, and ELV.

MDS (Material Data Sheets) are available on the EPCOS website for all types listed in the data book. MDS for customer specific capacitors are available upon request.

MSDS (Material Safety Data Sheets) are available for all of our electrolytes upon request.

Nevertheless, the following rules should be observed when handling aluminum electrolytic capacitors: No electrolyte should come into contact with eyes or skin. If electrolyte does come into contact with the skin, wash the affected areas immediately with running water. If the eyes are affected, rinse them for 10 minutes with plenty of water. If symptoms persist, seek medical treatment. Avoid inhaling electrolyte vapor or mists. Workplaces and other affected areas should be well ventilated. Clothing that has been contaminated by electrolyte must be changed and rinsed in water.

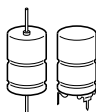

**B41693, B41793**

**High reliability – up to 150 °C**

### Product safety

The table below summarizes the safety instructions that must be observed without fail. A detailed description can be found in the relevant sections of chapter "General technical information".

Topic	Safety information	Reference chapter "General technical information"
Polarity	Make sure that polar capacitors are connected with the right polarity.	1 "Basic construction of aluminum electrolytic capacitors"
Reverse voltage	Voltages of opposite polarity should be prevented by connecting a diode.	3.1.6 "Reverse voltage"
Mounting position of screw-terminal capacitors	Screw terminal capacitors must not be mounted with terminals facing down unless otherwise specified.	11.1. "Mounting positions of capacitors with screw terminals"
Robustness of terminals	The following maximum tightening torques must not be exceeded when connecting screw terminals: M5: 2.5 Nm M6: 4.0 Nm	11.3 "Mounting torques"
Mounting of single-ended capacitors	The internal structure of single-ended capacitors might be damaged if excessive force is applied to the lead wires. Avoid any compressive, tensile or flexural stress. Do not move the capacitor after soldering to PC board. Do not pick up the PC board by the soldered capacitor. Do not insert the capacitor on the PC board with a hole space different to the lead space specified.	11.4 "Mounting considerations for single-ended capacitors"
Soldering	Do not exceed the specified time or temperature limits during soldering.	11.5 "Soldering"
Soldering, cleaning agents	Do not allow halogenated hydrocarbons to come into contact with aluminum electrolytic capacitors.	11.6 "Cleaning agents"
Upper category temperature	Do not exceed the upper category temperature.	7.2 "Maximum permissible operating temperature"
Passive flammability	Avoid external energy, e.g. fire.	8.1 "Passive flammability"

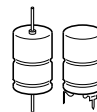

Topic	Safety information	Reference chapter "General technical information"
Active flammability	Avoid overload of the capacitors.	8.2 "Active flammability"
Maintenance	Make periodic inspections of the capacitors. Before the inspection, make sure that the power supply is turned off and carefully discharge the electricity of the capacitors. Do not apply excessive mechanical stress to the capacitor terminals when mounting.	10 "Maintenance"
Storage	Do not store capacitors at high temperatures or high humidity. Capacitors should be stored at +5 to +35 °C and a relative humidity of ≤ 75%.	7.3 "Shelf life and storage conditions"
		Reference chapter "Capacitors with screw terminals"
Breakdown strength of insulating sleeves	Do not damage the insulating sleeve, especially when ring clips are used for mounting.	"Screw terminals – accessories"

### Display of ordering codes for EPCOS products

The ordering code for one and the same product can be represented differently in data sheets, data books, other publications and the website of EPCOS, or in order-related documents such as shipping notes, order confirmations and product labels. The varying representations of the ordering codes are due to different processes employed and do not affect the specifications of the respective products. Detailed information can be found on the Internet under [www.epcos.com/orderingcodes](http://www.epcos.com/orderingcodes)

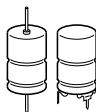

**B41693, B41793**

**High reliability – up to 150 °C**

## Symbols and terms

Symbol	English	German
C	Capacitance	Kapazität
$C_R$	Rated capacitance	Nennkapazität
$C_S$	Series capacitance	Serienkapazität
$C_{S,T}$	Series capacitance at temperature T	Serienkapazität bei Temperatur T
$C_f$	Capacitance at frequency f	Kapazität bei Frequenz f
d	Case diameter, nominal dimension	Gehäusedurchmesser, Nennmaß
$d_{max}$	Maximum case diameter	Maximaler Gehäusedurchmesser
ESL	Self-inductance	Eigeninduktivität
ESR	Equivalent series resistance	Ersatzserienwiderstand
$ESR_f$	Equivalent series resistance at frequency f	Ersatzserienwiderstand bei Frequenz f
$ESR_T$	Equivalent series resistance at temperature T	Ersatzserienwiderstand bei Temperatur T
f	Frequency	Frequenz
I	Current	Strom
$I_{AC}$	Alternating current (ripple current)	Wechselstrom
$I_{AC,RMS}$	Root-mean-square value of alternating current	Wechselstrom, Effektivwert
$I_{AC,f}$	Ripple current at frequency f	Wechselstrom bei Frequenz f
$I_{AC,max}$	Maximum permissible ripple current	Maximal zulässiger Wechselstrom
$I_{AC,R}$	Rated ripple current	Nennwechselstrom
$I_{leak}$	Leakage current	Reststrom
$I_{leak,op}$	Operating leakage current	Betriebsreststrom
l	Case length, nominal dimension	Gehäuselänge, Nennmaß
$l_{max}$	Maximum case length (without terminals and mounting stud)	Maximale Gehäuselänge (ohne Anschlüsse und Gewindebolzen)
R	Resistance	Widerstand
$R_{ins}$	Insulation resistance	Isolationswiderstand
$R_{symm}$	Balancing resistance	Symmetrierwiderstand
T	Temperature	Temperatur
$\Delta T$	Temperature difference	Temperaturdifferenz
$T_A$	Ambient temperature	Umgebungstemperatur
$T_C$	Case temperature	Gehäusetemperatur
$T_B$	Capacitor base temperature	Temperatur des Gehäusebodens
t	Time	Zeit
$\Delta t$	Period	Zeitraum
$t_b$	Service life (operating hours)	Brauchbarkeitsdauer (Betriebszeit)



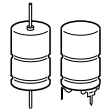

Symbol	English	German
V	Voltage	Spannung
V <sub>F</sub>	Forming voltage	Formierspannung
V <sub>op</sub>	Operating voltage	Betriebsspannung
V <sub>R</sub>	Rated voltage, DC voltage	Nennspannung, Gleichspannung
V <sub>S</sub>	Surge voltage	Spitzenspannung
X <sub>C</sub>	Capacitive reactance	Kapazitiver Blindwiderstand
X <sub>L</sub>	Inductive reactance	Induktiver Blindwiderstand
Z	Impedance	Scheinwiderstand
Z <sub>T</sub>	Impedance at temperature T	Scheinwiderstand bei Temperatur T
tan δ	Dissipation factor	Verlustfaktor
λ	Failure rate	Ausfallrate
ε <sub>0</sub>	Absolute permittivity	Elektrische Feldkonstante
ε <sub>r</sub>	Relative permittivity	Dielektrizitätszahl
ω	Angular velocity; 2 · π · f	Kreisfrequenz; 2 · π · f

**Note**

All dimensions are given in mm.

## Important notes

The following applies to all products named in this publication:

1. Some parts of this publication contain **statements about the suitability of our products for certain areas of application**. These statements are based on our knowledge of typical requirements that are often placed on our products in the areas of application concerned. We nevertheless expressly point out **that such statements cannot be regarded as binding statements about the suitability of our products for a particular customer application**. As a rule, EPCOS is either unfamiliar with individual customer applications or less familiar with them than the customers themselves. For these reasons, it is always ultimately incumbent on the customer to check and decide whether an EPCOS product with the properties described in the product specification is suitable for use in a particular customer application.
2. We also point out that **in individual cases, a malfunction of electronic components or failure before the end of their usual service life cannot be completely ruled out in the current state of the art, even if they are operated as specified**. In customer applications requiring a very high level of operational safety and especially in customer applications in which the malfunction or failure of an electronic component could endanger human life or health (e.g. in accident prevention or lifesaving systems), it must therefore be ensured by means of suitable design of the customer application or other action taken by the customer (e.g. installation of protective circuitry or redundancy) that no injury or damage is sustained by third parties in the event of malfunction or failure of an electronic component.
3. **The warnings, cautions and product-specific notes must be observed.**
4. In order to satisfy certain technical requirements, **some of the products described in this publication may contain substances subject to restrictions in certain jurisdictions (e.g. because they are classed as hazardous)**. Useful information on this will be found in our Material Data Sheets on the Internet ([www.epcos.com/material](http://www.epcos.com/material)). Should you have any more detailed questions, please contact our sales offices.
5. We constantly strive to improve our products. Consequently, **the products described in this publication may change from time to time**. The same is true of the corresponding product specifications. Please check therefore to what extent product descriptions and specifications contained in this publication are still applicable before or when you place an order. We also **reserve the right to discontinue production and delivery of products**. Consequently, we cannot guarantee that all products named in this publication will always be available. The aforementioned does not apply in the case of individual agreements deviating from the foregoing for customer-specific products.
6. Unless otherwise agreed in individual contracts, **all orders are subject to the current version of the "General Terms of Delivery for Products and Services in the Electrical Industry" published by the German Electrical and Electronics Industry Association (ZVEI)**.

## Important notes

7. The trade names EPCOS, Alu-X, CeraDiode, CeraLink, CeraPad, CeraPlas, CSMP, CSSP, CTVS, DeltaCap, DigiSiMic, DSSP, FilterCap, FormFit, LeaXield, MiniBlue, MiniCell, MKD, MKK, MLSC, MotorCap, PCC, PhaseCap, PhaseCube, PhaseMod, PhiCap, PQSine, SIFERRIT, SIFI, SIKOREL, SilverCap, SIMDAD, SiMic, SIMID, SineFormer, SIOV, SIP5D, SIP5K, TFAP, ThermoFuse, WindCap are **trademarks registered or pending** in Europe and in other countries. Further information will be found on the Internet at [www.epcos.com/trademarks.vvv](http://www.epcos.com/trademarks.vvv)