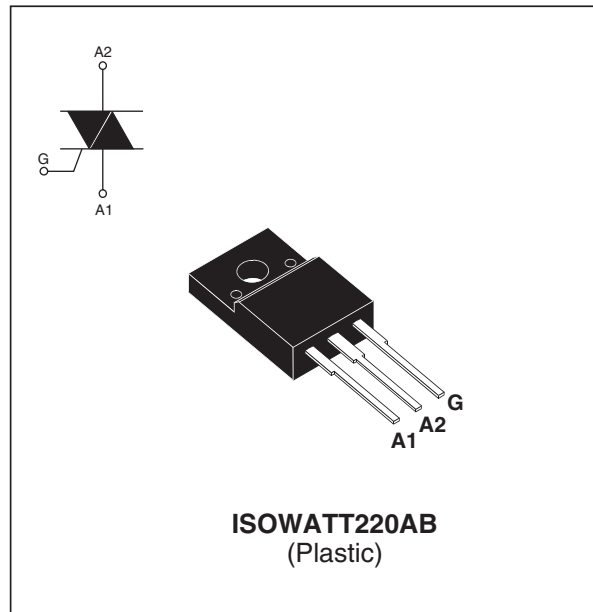


**MAIN FEATURES**

Symbol	Value	Unit
$I_{T(RMS)}$	8	A
$V_{DRM}/V_{RRM}$	600 and 800	V
$I_{GT}$	20 to 30	mA

**DESCRIPTION**

Based on ST' Snubberless technology providing high commutation performances, the T820-600W/800W are specially recommended for use on inductive loads, thanks to their high commutation performances, such as washing-machines drum motor controllers. They comply with UL standards (ref. E81734).



**ABSOLUTE RATINGS** (limiting values)

Symbol	Parameter		Value	Unit
$I_{T(RMS)}$	RMS on-state current (Full sine wave)		$T_c = 100^\circ\text{C}$ 8	A
$I_{TSM}$	Non repetitive surge peak on-state current (Full cycle, $T_j$ initial = $25^\circ\text{C}$ )	F = 50Hz t = 20ms	100	A
		F = 60Hz t = 16.7ms	105	
$I^2t$	$I^2t$ Value for fusing	tp = 10 ms	55	$\text{A}^2\text{s}$
dl/dt	Critical rate of rise of on-state current $I_G = 2 \times I_{GT}$ , tr ≤ 100ns	F = 120 Hz $T_j = 125^\circ\text{C}$	50	$\text{A}/\mu\text{s}$
$V_{DSM}/V_{RSM}$	Non repetitive surge peak off-state voltage	tp = 10ms $T_j = 25^\circ\text{C}$	$V_{DRM}/V_{RRM} + 100$	V
$I_{GM}$	Peak gate current	tp = 20μs $T_j = 125^\circ\text{C}$	4	A
$P_{G(AV)}$	Average gate power dissipation		$T_j = 125^\circ\text{C}$ 1	W
$T_{stg}$ $T_j$	Storage junction temperature range Operating junction temperature range		- 40 to + 150 - 40 to + 125	$^\circ\text{C}$

## T820W / T830W

### ELECTRICAL CHARACTERISTICS (T<sub>j</sub> = 25°C, unless otherwise specified)

Symbol	Test Conditions	Quadrant		T820	T830	Unit
I <sub>GT</sub> <sup>(1)</sup>	V <sub>D</sub> =12V R <sub>L</sub> =33Ω	I-II-III	MAX.	20	30	mA
V <sub>GT</sub>		I-II-III	MAX.	1.3		V
V <sub>GD</sub>	V <sub>D</sub> =V <sub>DRM</sub> R <sub>L</sub> =3.3kΩ T <sub>j</sub> = 125°C	I-II-III	MIN.	0.2		V
I <sub>H</sub> <sup>(2)</sup>	I <sub>T</sub> = 250mA		MAX.	35	50	mA
I <sub>L</sub>	I <sub>G</sub> = 1.2I <sub>GT</sub>	I - III	MAX.	50	70	mA
		II	MAX.	60	80	mA
dV/dt <sup>(2)</sup>	V <sub>D</sub> =67% V <sub>DRM</sub> Gate open T <sub>j</sub> = 125°C		MIN.	300	500	V/μs
(dI/dt) <sub>c</sub> <sup>(2)</sup>	Without snubber T <sub>j</sub> = 125°C		MIN.	4.5	5.5	A/ms

### STATIC CHARACTERISTICS

Symbol	Test Conditions			Value	Unit
V <sub>TM</sub> <sup>(2)</sup>	I <sub>TM</sub> = 11A t <sub>p</sub> = 380μs	T <sub>j</sub> = 25°C	MAX.	1.4	V
V <sub>TO</sub> <sup>(2)</sup>	Threshold voltage	T <sub>j</sub> = 125°C	MAX.	0.85	V
R <sub>d</sub> <sup>(2)</sup>	Dynamic resistance	T <sub>j</sub> = 125°C	MAX.	40	mΩ
I <sub>DRM</sub> I <sub>RRM</sub>	V <sub>DRM</sub> = V <sub>RRM</sub>	T <sub>j</sub> = 25°C T <sub>j</sub> = 125°C	MAX	5 1	μA mA

**Note 1:** Minimum IGT is guaranteed at 5% of IGT max.

**Note 2:** For both polarities of A2 referenced to A1.

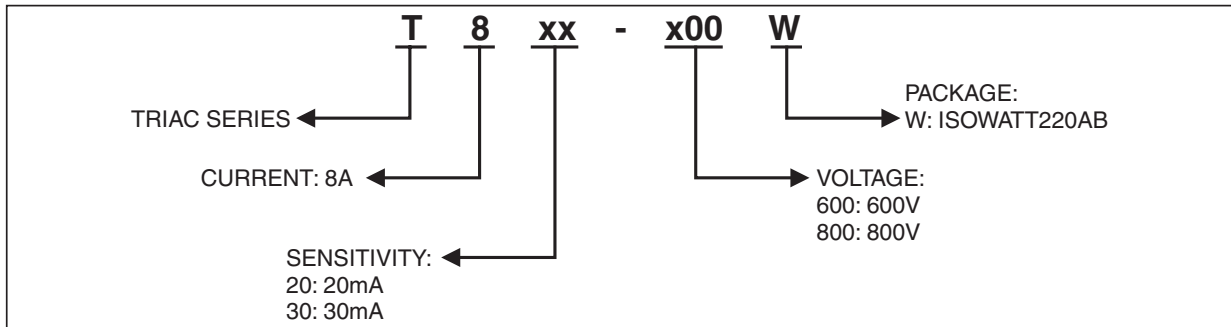
### THERMAL RESISTANCES

Symbol	Parameter	Value	Unit
R <sub>th(j-a)</sub>	Junction to ambient	60	°C/W
R <sub>th(j-c)</sub>	Junction to case (AC)	3.1	°C/W

### PRODUCT SELECTOR

Part Number	Voltage	Sensitivity	Type	Package
T820-600W	600V	20 mA	Snubberless	ISOWATT220AB
T820-800W	800V	20 mA	Snubberless	ISOWATT220AB
T830-600W	600V	30 mA	Snubberless	ISOWATT220AB
T830-800W	800V	30 mA	Snubberless	ISOWATT220AB

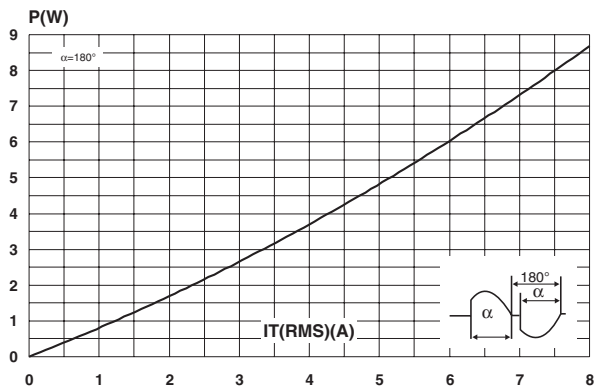
**ORDERING INFORMATION**



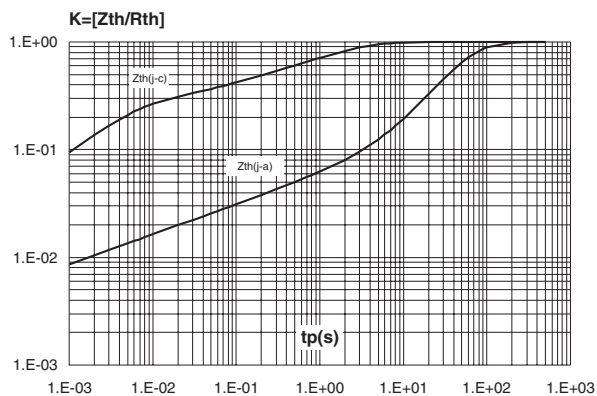
**OTHER INFORMATION**

Part Number	Marking	Weight	Base quantity	Packing mode
T820-600W	T820600W	2.3 g	50	Tube
T820-800W	T820800W	2.3 g	50	Tube
T830-600W	T830600W	2.3 g	50	Tube
T830-800W	T830800W	2.3 g	50	Tube

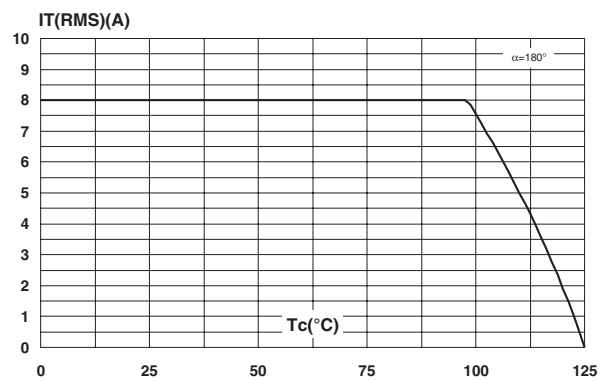
**Fig. 1:** Maximum power dissipation versus RMS on-state current.



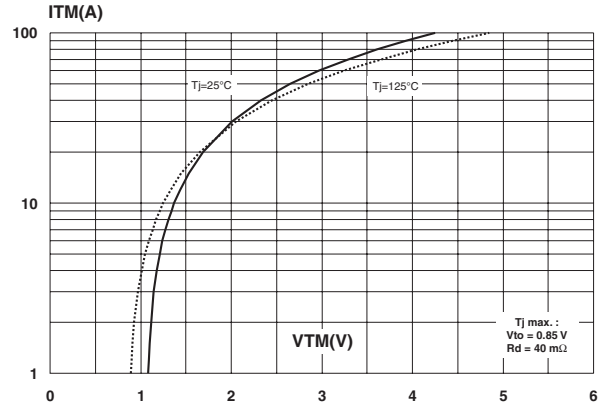
**Fig. 3:** Relative variation of thermal impedance versus pulse duration.



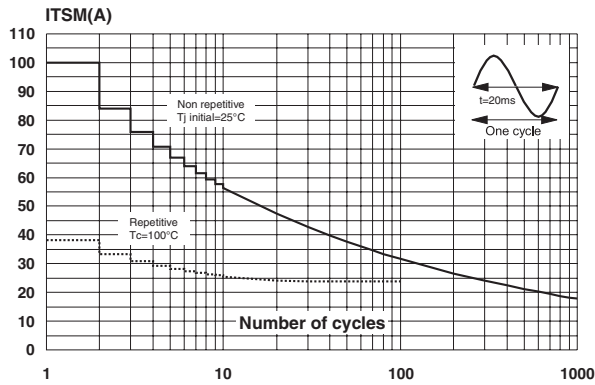
**Fig. 2:** RMS on-state current versus case temperature.



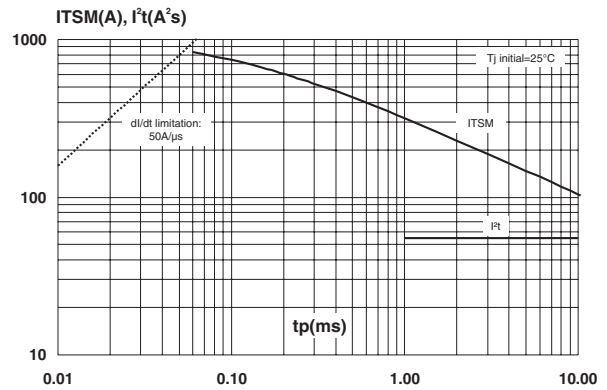
**Fig. 4:** On-state characteristics (maximum values).



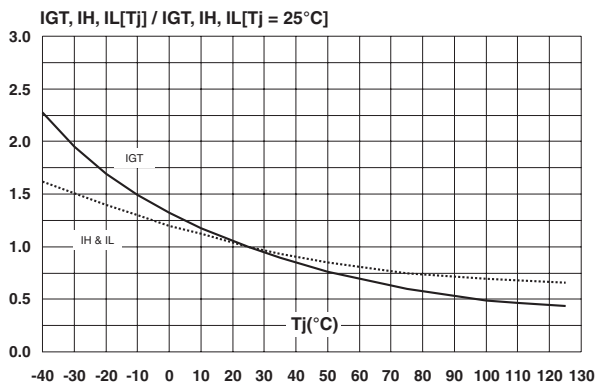
**Fig. 5:** Surge peak on-state current versus number of cycles.



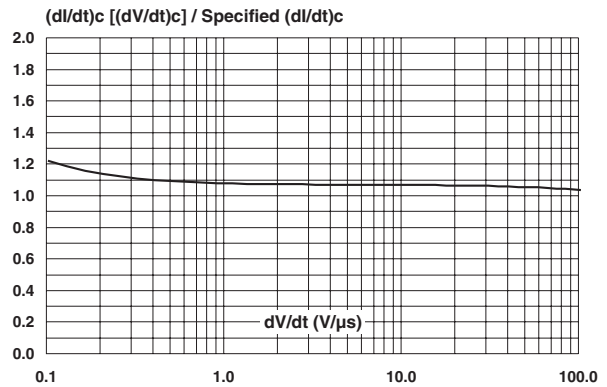
**Fig. 6:** Non repetitive surge peak on-state current for a sinusoidal pulse with width  $t_p < 10\text{ms}$ , and corresponding value of  $I^2t$ .



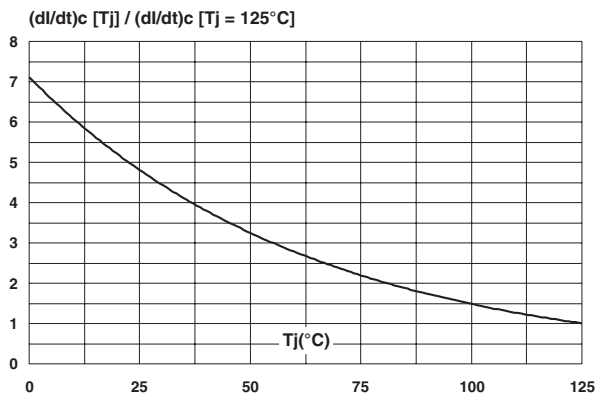
**Fig. 7:** Relative variation of gate trigger current, holding current and latching current versus junction temperature (typical values).

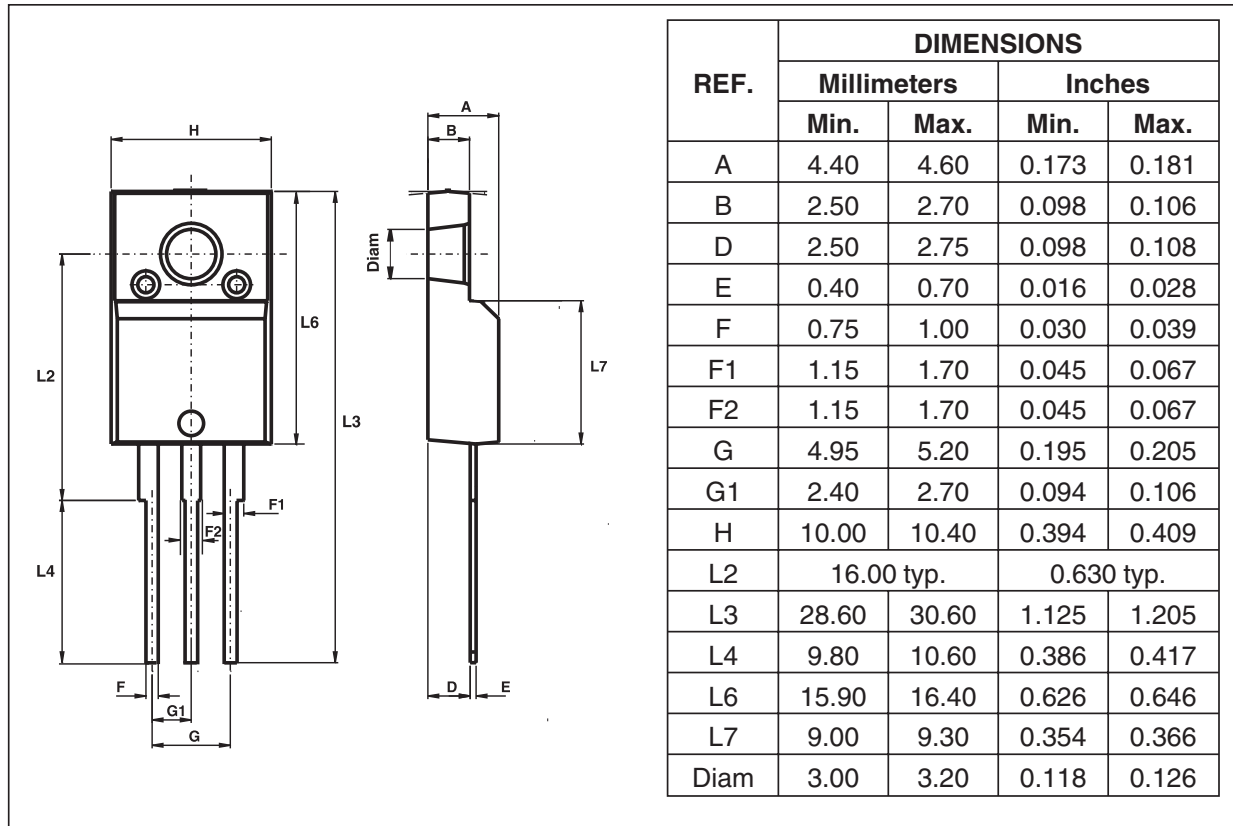


**Fig. 8:** Relative variation of critical rate of decrease of main current versus reapplied  $dV/dt$  (typical values).



**Fig. 9:** Relative variation of critical rate of decrease of main current versus junction temperature.



**PACKAGE MECHANICAL DATA**  
 ISOWATT220AB


- Cooling method : C
- Recommended torque value : 0.55 m.N.
- Maximum torque value : 0.70 m.N.