

MORNSUN®

LS05 Series 5W, AC-DC CONVERTER

LS05 Series -----are high efficient green power modules with miniature packaging provided by Mornsun. The series is featured by wide input voltage range, high efficiency, high reliability, low power consumption and safety isolation etc. They are widely used in industrial, official and civil equipments which have no special requirement for EMC performance. For harsh EMC environment, please refer to the EMC recommended circuits.

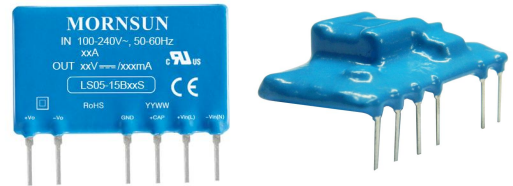

PRODUCT FEATURES

1. Wide input voltage: 85 ~ 264VAC (100 ~ 400VDC)
2. Over current protection and short-circuit protection
3. High efficiency, High security isolation: 3000VAC
4. Ultra-Miniature package
5. Industrial design
6. 90 degree curved series, minimizing product height
7. Certificate UL60950/EN60950 standards

PART NUMBER SYSTEM

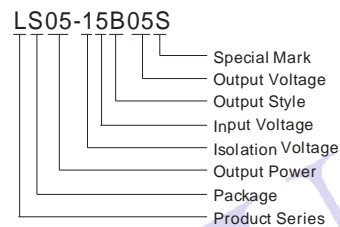

SELECTION GUIDE

Approval	Model	Power	Output (Vo/Io)	Max. Capacitive Load (μF)	Ripple and Noise (Max.)	Efficiency (%) (230VAC, Typ.)	Standby Power (Max.)
UL (beside "-F")	LS05-15B03S(-F)*	5W	3.3V/1000mA	2200	150mV	65	0.5W
	LS05-15B05S(-F)		5V/1000mA	1500	120mV	70	
	LS05-15B09S(-F)		9V/560mA	680	120mV	72	
	LS05-15B12S(-F)		12V/420mA	470	120mV	74	
	LS05-15B15S(-F)		15V/340mA	330	120mV	75	
	LS05-15B24S(-F)		24V/210mA	100	150mV	75	

Note:* The model of 90 degrees of corner is with F. For example the LS05-15B12S of 90 degrees of corner product is LS05-15B12S-F.

INPUT SPECIFICATIONS

Item	Test Conditions	Min.	Typ.	Max.	Unit
Input Voltage Range	AC Input	85	--	264	V
	DC Input	100	--	400	
Input Frequency		47	--	440	Hz
Input Current	115VAC	--	--	0.2	A
	230VAC	--	--	0.1	
Inrush Current	115VAC	--	20	--	A
	230VAC	--	30	--	
leakage Current	CY0 is 1nF/400VAC	--	--	0.25	mA

OUTPUT SPECIFICATIONS

Item	Test Conditions	Min.	Typ.	Max.	Unit
Output Voltage Accuracy	LS05-15B03S(-F)	--	±2.0	±3.0	%
	LS05-15B05S(-F)	--	±1.0	±2.0	
	LS05-15B09S(-F)	--			
	LS05-15B12S(-F)	--			
	LS05-15B15S(-F)	--			
	LS05-15B24S(-F)	--			
Line Regulation	full load	--	±0.1	±0.5	
Load Regulation	10% to 100%	--	±1.0	±1.5	
Ripple & Noise (p-p) (measuring refer to "RIPPLE AND NOISE MEASURE FIGURE")	20MHz bandwidth	--	50	150	mV

The copyright and authority for the interpretation of the products are reserved by MORNSUN

Specifications subject to change without notice.
LS05(-F) series 2013.08.29-A/1 Page 1 of 5

Min Load		10	--	--	%
Hold-up Time	115VAC	20	--	--	ms
	230VAC	80	--	--	
Short Circuit Protection		Continuous, and auto recovery			
Over Current Protection		≥110%Io, Auto recovery			
Over Voltage Protection		Zener diode clamp			

COMMON SPECIFICATIONS

Item	Test Conditions	Min.	Typ.	Max.	Unit
Operating Temperature		-25	--	+85	°C
Storage Temperature		-40	--	+105	
Surface temperature		--	--	+100	
Storage Humidity		--	--	85	%RH
Temperature coefficient		--	±0.02	--	% / °C
Power derating	-25°C ~ +0°C	0.8	--	--	
	+55°C ~ +85°C	1.33	--	--	
Isolation Resistance		100	--	--	MΩ
Isolation Voltage	input-output Tested for 1 minute(leakage current setting value:5 mA)	3000	--	--	VAC
Switching Frequency		--	100	--	kHz
Weight		--	10	--	g
Welding Temperature	Wave-soldering	260 ± 5°C; time:5-10s			
	Manual-welding	360 ± 10°C; time:3-5s			
Safety approvals		EN60950/UL60950			
Safety Class		CLASS II			
Safety standards		IEC60950/EN60950/UL60950			
Hot swap		Forbid			
Install		PCB			
Cooling		Free air convection			
MTBF		>300,000 h @ 25°C			

- Note: 1. External electrolytic capacitors are required to modules, more details refer to typical applications.
2. Ripple and Noise measuring refer to "RIPPLE AND NOISE MEASURE FIGURE".
3. All specifications were measured at Ta=25°C, humidity<75%, nominal input voltage(115VAC or 230VAC) and rated output load unless otherwise specified.
4. In this datasheet, all the test methods of indications are based on corporate standards.
5. When working under high vibration, the product need to be glued for fixing.

EMC SPECIFICATIONS

EMI	CE	CISPR22/EN55022, CLASS A (with typical applications Figure 1)				
		CISPR22/EN55022, CLASS B (with typical applications Figure 3)				
	RE	CISPR22/EN55022, CLASS B (with typical applications Figure 1 or Figure 3)				
EMS	ESD	IEC/EN61000-4-2	Contact ±4KV		perf. Criteria B	
	RS	IEC/EN61000-4-3	10V/m		perf. Criteria A	
	EFT	IEC/EN61000-4-4	±2KV	(with typical applications Figure 1)		perf. Criteria B
			±4KV	(with typical applications Figure 3)		perf. Criteria B
	Surge	IEC/EN61000-4-5	±1KV/±2KV	(with typical applications Figure 3)		perf. Criteria B
	CS	IEC/EN61000-4-6	3 Vr.m.s	(with typical applications Figure 3)		perf. Criteria A
	PFM	IEC/EN61000-4-8	10A/m			perf. Criteria A
Voltage dips, short and interruptions immunity	IEC/EN61000-4-11	0%-70%			perf. Criteria B	

RIPPLE AND NOISE MEASURE FIGURE

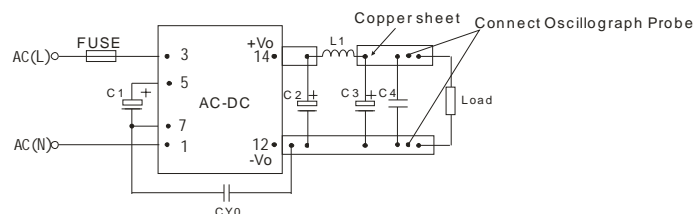

Note: CY0 is 1nF/400VAC Y1 capacitor, C1,C2,L1,C3,C4 refer to "EXTERNAL CIRCUIT PARAMETERS"

PRODUCT TYPICAL CURVE

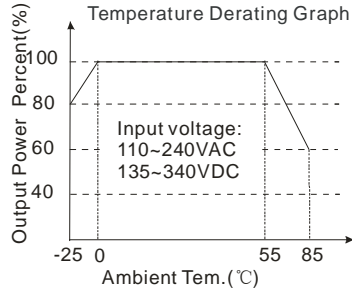

Note: When input 85~110VAC or 240~264VAC, it need to be voltage derated on basis of temperature derating.

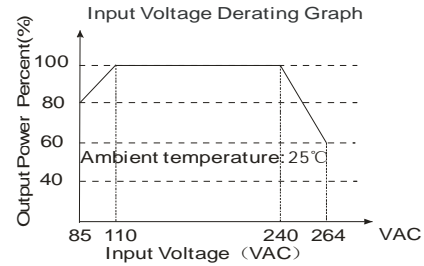

Note: When input DC, VDC=1.414*VAC-20.

LS05-15B12S(-F) AC input efficiency cure

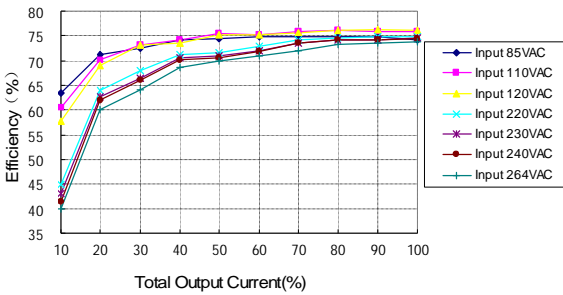

LS05-15B12S(-F) DCinput efficiency cure

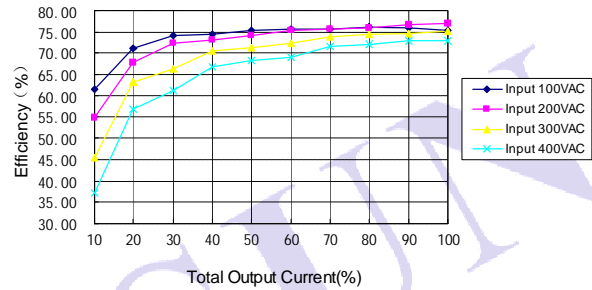

Efficiency VS Input Voltage curve (Full Load)

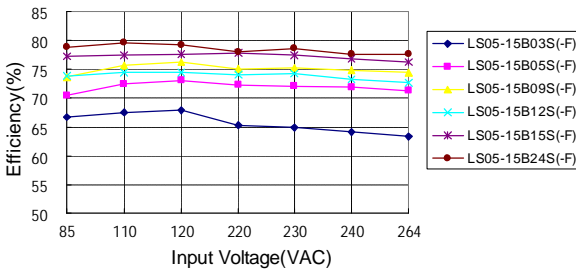

Efficiency VS Input Voltage curve (Full Load)

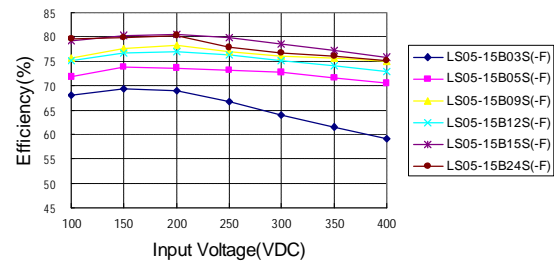

STRUCTURE FIGURE

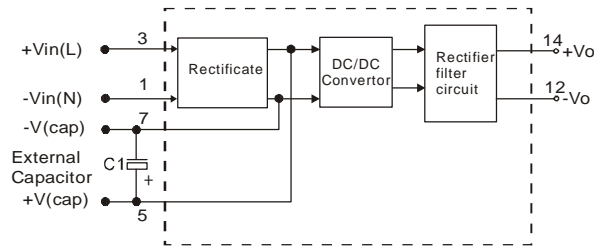

TYPICAL APPLICATIONS

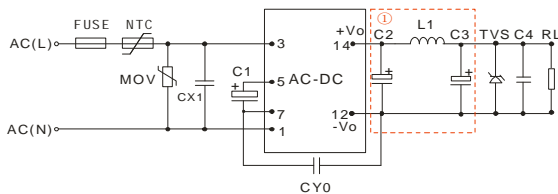

(Figure 1): Typical application circuit
Note: ① is Pi filter circuit.

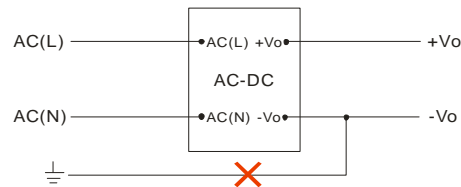

(Figure 2): Because of the surge protection, this application is not available for this series.
Note: If you have such application, please consult to our FAE department.

EMC RECOMMENDED CIRCUIT

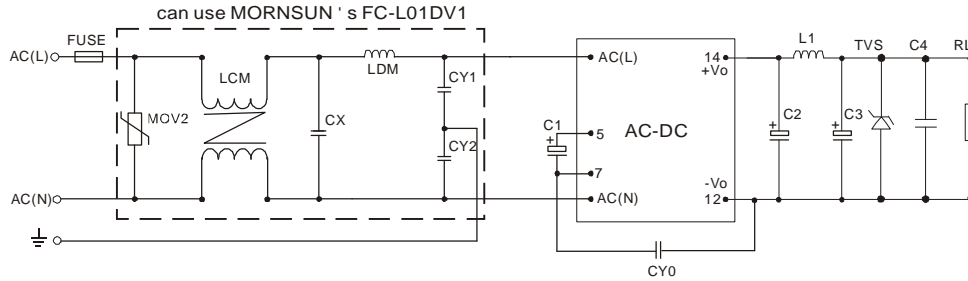

(Figure 3): Recommended circuit for applications which require higher EMC standard

EMC RECOMMENDED CIRCUIT PCB LAYOUT

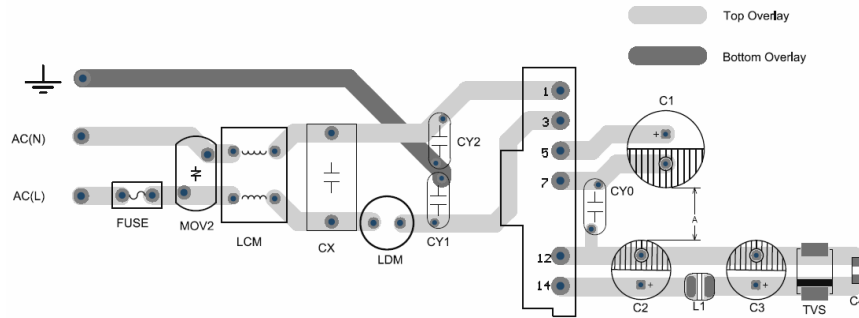

Figure 4: EMC application circuit PCB layout

Safety and recommend wiring: linewidth $\geq 3\text{mm}$, line-line distance $\geq 6\text{mm}$, line-ground distance $\geq 6\text{mm}$, $A \geq 6.4\text{mm}$

EXTERNAL CIRCUIT PARAMETERS										
Model	C1 (Required)	C2 (Required)	L1 (Required)	C3 (Required)	CX1	C4	CY0	FUSE (Required)	TVS	
LS05-15B03S(-F)	22 μF /400V	470 μF /10V	0.47 μH	150 μF /35V	0.1 μF /275V AC	100nF/50V	1nF/400 VAC	1A/250V	SMBJ7.0A	
LS05-15B05S(-F)		470 μF /16V								
LS05-15B09S(-F)		330 μF /25V	1 μH	150 μF /35V						SMBJ12A
LS05-15B12S(-F)										
LS05-15B15S(-F)										
LS05-15B24S(-F)		100 μF /35V	4.7 μH	47 μF /35V						SMBJ30A

Note:

1. C1, C2 and C3 are electrolytic capacitors. They are required both AC input and DC input.

When AC input, C1 is used as filter capacitor, the value of C1 is recommended to be 22 μF /400V. When DC input, C1 is used as EMC filter capacitor, the value of C1 is recommended to be 10 μF /400V (when the input voltage is above 370VDC, the recommended value of C1 is 10 μF /450V). C2 and C3 are output filter capacitors, they are recommended to be high frequency and low impedance electrolytic capacitors. Capacitance and rated ripple current of capacitors refer to the datasheets provided by the manufactures. Voltage derating of capacitors should be 80% or above. C4 is a ceramic capacitor, which is used to filter high frequency noise. C2, C3 and L1 form a pi filter circuit. Current of L1 refer to the datasheets provided by the manufactures, current derating should be 80% or above. To protect post-circuits (if converter fails), TVS is recommended. And the external NTC thermistor is recommended to be 5D-9. External input MOV is recommended to use S14K350.

2. For standard EMC requirement, please refer to figure 1. If higher EMC requirement, please refer to figure 3, recommended parameters are shown in the table below.

Recommend Parameter For Higher EMC Standard Circuit	
Components	Recommend Parameter
MOV2	S10K300
CY1, CY2	1nF/400VAC
CX	0.1 μF /275VAC
LCM	3.5mH
LDM	5mH
FC-L01DV1	MORNSUN's 1KV/2KV Surge protector
FUSE	1A/250V, slow blow, it must be connected to FUSE

LS05-15BXXS DIMENSIONS, RECOMMENDED FOOTPRINT

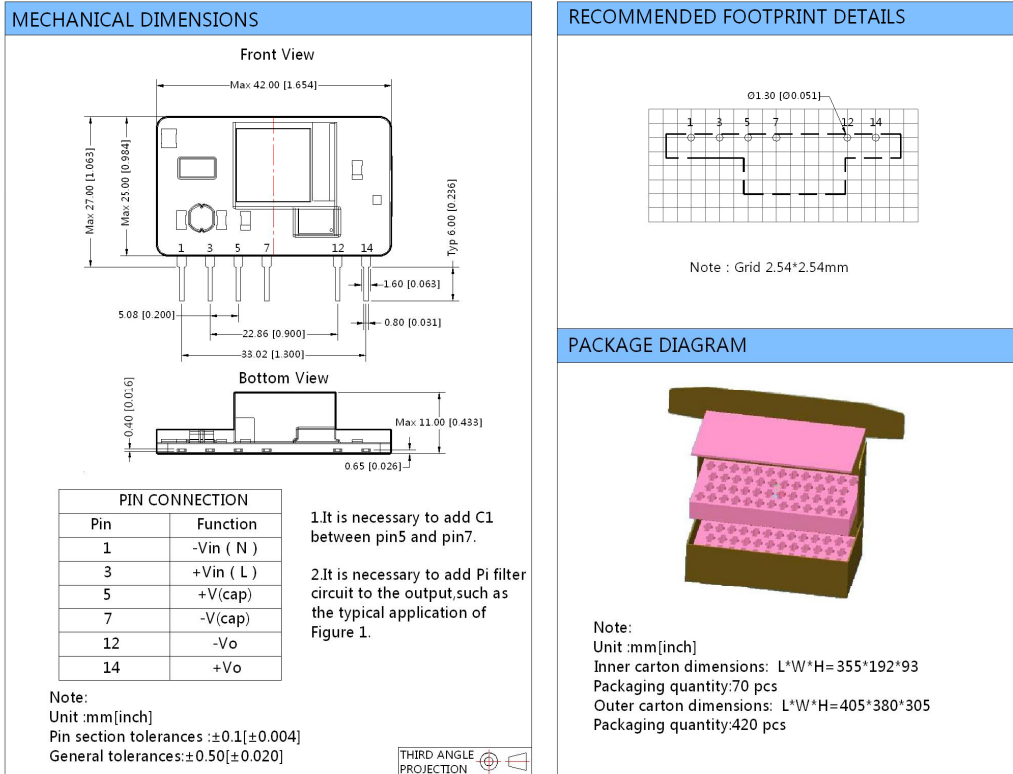

LS05-15BXXS-F DIMENSIONS, RECOMMENDED FOOTPRINT

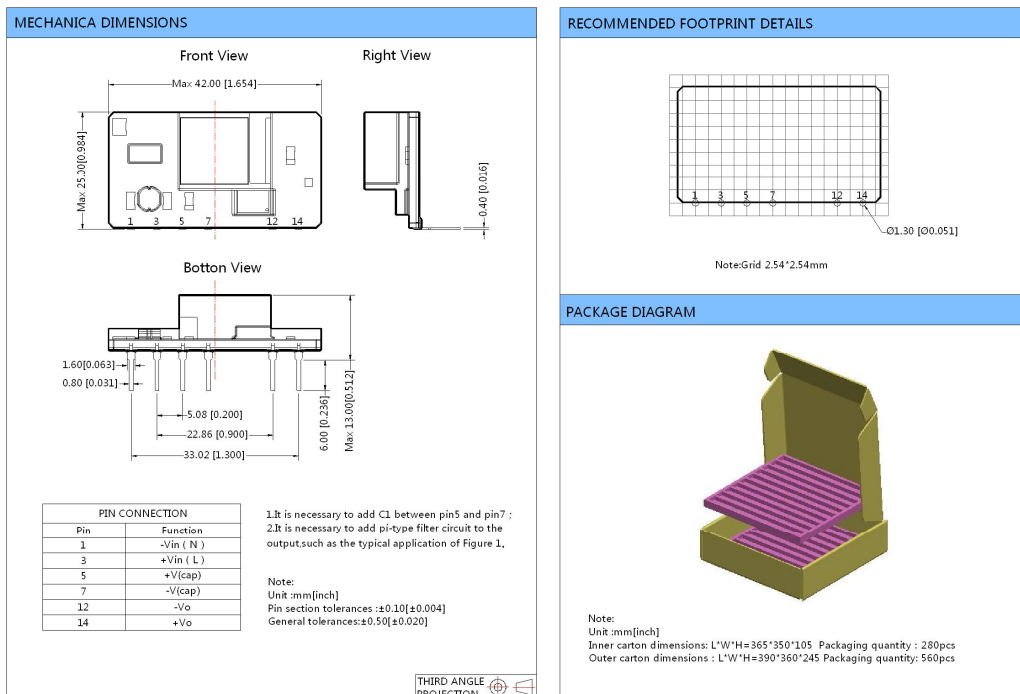

MORNSUN Science & Technology Co.,Ltd.

Address: No. 5, Kehui St. 1, Kehui development center, Science Ave., Guangzhou Science City, Luogang district, Guangzhou,P.R.China.

Tel: 86-20-38601850

Fax:86-20-38601272

E-mail: info@mornsun.cn

<http://www.mornsun-power.com>

The copyright and authority for the interpretation of the products are reserved by MORNSUN

Specifications subject to change without notice.
LS05(-F) series 2013.08.29-A/1 Page 5 of 5