



# DS60-P31211

Dx60

MID RANGE DISTANCE SENSORS

**SICK**  
Sensor Intelligence.



### Ordering information

Type	Part no.
DS60-P31211	1019132

Other models and accessories → [www.sick.com/Dx60](http://www.sick.com/Dx60)



### Detailed technical data

#### Performance

<b>Measuring range</b>	80 mm ... 6,000 mm, 90 % remission <sup>1)</sup> 80 mm ... 4,600 mm, 18 % remission <sup>1)</sup> 80 mm ... 2,400 mm, 6 % remission <sup>1)</sup>
<b>Response time</b>	50 ms
<b>Switching frequency</b>	10 Hz
<b>Light source</b>	Laser, red
<b>Laser class</b>	2 (EN 60825-1)
<b>Typ. light spot size (distance)</b>	9 mm x 9 mm (at 4.5 m)
<b>Additional function</b>	Invertable switching output, ObSB mode
<b>Laser service life (MTTF at 25 °C)</b>	50,000 h

<sup>1)</sup> Teach-in from 200 ... 6,000 mm.

#### Interfaces

<b>Switching output</b>	2x PNP (100 mA) <sup>1) 2)</sup>
-------------------------	----------------------------------

<sup>1)</sup> Output Q short-circuit protected.

<sup>2)</sup> PNP: HIGH =  $V_S - (< 2.5 V)$  / LOW =  $< 2.5 V$ ; NPN: HIGH =  $< 2.5 V$  / LOW =  $V_S$ .

#### Mechanics/electronics

<b>Supply voltage <math>V_S</math></b>	DC 18 V ... 30 V <sup>1)</sup>
<b>Ripple</b>	$\leq 5 V_{pp}$ <sup>2)</sup>
<b>Power consumption</b>	$\leq 3 W$ <sup>3)</sup>
<b>Connection type</b>	Male connector, M12, 5-pin
<b>Weight</b>	202 g

<sup>1)</sup> Limit values, reverse-polarity protected, operation in short-circuit protected network: max. 8 A.

<sup>2)</sup> May not fall short of or exceed  $V_S$  tolerances.

<sup>3)</sup> Without load.

### Ambient data

<b>Enclosure rating</b>	IP 67
<b>Protection class</b>	II
<b>Electromagnetic compatibility (EMC)</b>	EN 61000-6-2 EN 60947-5-2
<b>Ambient temperature</b>	Operation: -25 °C ... +55 °C Storage: -25 °C ... +75 °C

### Dimensional drawing (Dimensions in mm (inch))

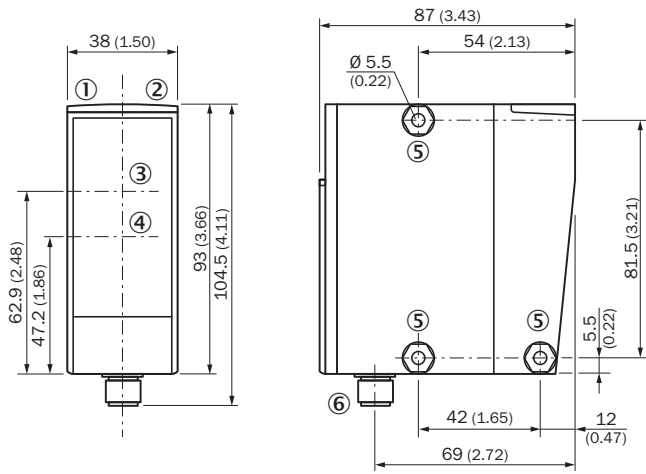

- ① Status indicator switching output 1
- ② Status indicator switching output 2
- ③ Optical axis sender
- ④ Optical axis receiver
- ⑤ Mounting hole, Ø 5.2 mm
- ⑥ Male connector M12, 5-pin

### Connection type

Male connector M12, 5-pin

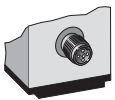

### Connection diagram

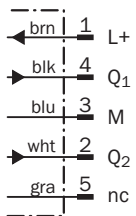

Adjustment possible

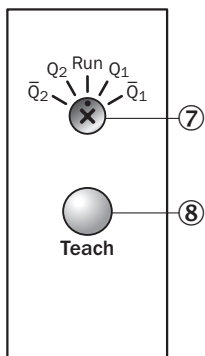

- ⑦ Rotary switch
- ⑧ Control element

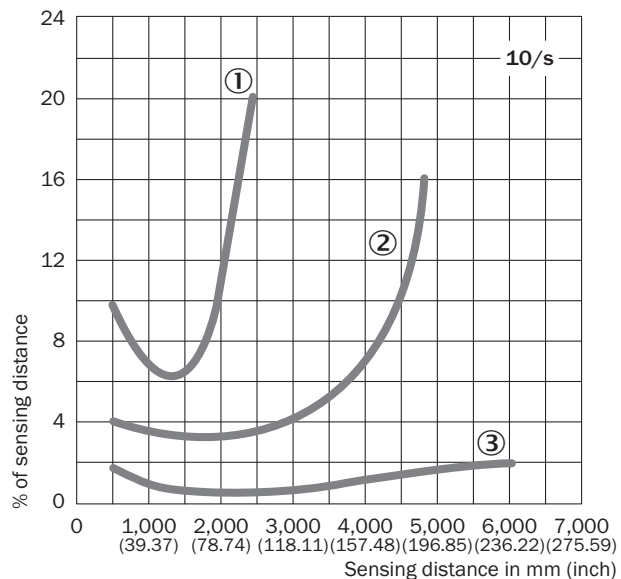

Sensing distance



- ① 6 % / 90 %
- ② 18 % / 90 %
- ③ 90 % / 90 %

## Recommended accessories

Other models and accessories → [www.sick.com/Dx60](http://www.sick.com/Dx60)

	Brief description	Type	Part no.
<b>Mounting brackets and mounting plates</b>			
	Mounting bracket, steel, zinc coated, without mounting hardware	BEF-WN-DS60	4032937
<b>Plug connectors and cables</b>			
	Head A: female connector, M12, 5-pin, straight Head B: cable Cable: PVC, unshielded, 2 m	DOL-1205-G02M	6008899
	Head A: female connector, M12, 5-pin, straight Head B: cable Cable: PVC, unshielded, 5 m	DOL-1205-G05M	6009868
	Head A: female connector, M12, 5-pin, straight Head B: cable Cable: PVC, unshielded, 10 m	DOL-1205-G10M	6010544
	Head A: female connector, M12, 5-pin, angled Head B: cable Cable: PVC, unshielded, 2 m	DOL-1205-W02M	6008900
	Head A: female connector, M12, 5-pin, angled Head B: cable Cable: PVC, unshielded, 5 m	DOL-1205-W05M	6009869
	Head A: female connector, M12, 5-pin, angled Head B: cable Cable: PVC, unshielded, 10 m	DOL-1205-W10M	6010542
<b>Reflectors</b>			
	"Diamond grade" reflective tape, self-adhesive, ready to assemble from the sheet, 74.9 cm x 91.4 cm <sup>1)</sup> , self-adhesive	REF-DG-K	4019634

<sup>1)</sup> Customizable length by sheet. Width max. 74.9 cm, length max. 91.4 cm.

## SICK AT A GLANCE

SICK is one of the leading manufacturers of intelligent sensors and sensor solutions for industrial applications. A unique range of products and services creates the perfect basis for controlling processes securely and efficiently, protecting individuals from accidents and preventing damage to the environment.

We have extensive experience in a wide range of industries and understand their processes and requirements. With intelligent sensors, we can deliver exactly what our customers need. In application centers in Europe, Asia and North America, system solutions are tested and optimized in accordance with customer specifications. All this makes us a reliable supplier and development partner.

Comprehensive services complete our offering: SICK LifeTime Services provide support throughout the machine life cycle and ensure safety and productivity.

For us, that is “Sensor Intelligence.”

## WORLDWIDE PRESENCE:

Contacts and other locations –[www.sick.com](http://www.sick.com)