

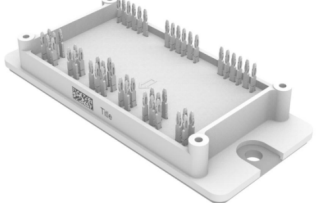
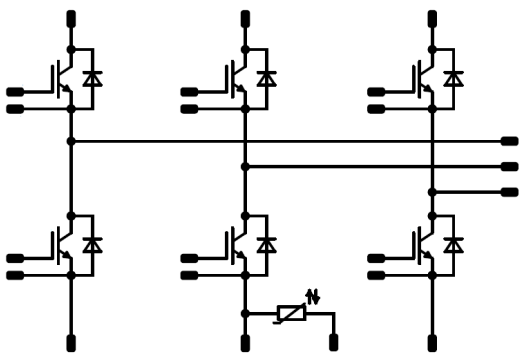

Vincotech

<i>flow</i> PACK 2	1200 V / 50 A
<div style="border: 1px solid black; padding: 5px; margin-bottom: 5px;"> <p style="text-align: center; background-color: #ccc; margin: 0;">Features</p> <ul style="list-style-type: none"> Mitsubishi generation 6.1 (1200V) technology for low saturation losses and improved EMC behavior Compact and low inductive design Integrated temperature sensor </div> <div style="border: 1px solid black; padding: 5px; margin-bottom: 5px;"> <p style="text-align: center; background-color: #ccc; margin: 0;">Target applications</p> <ul style="list-style-type: none"> Industrial drives </div> <div style="border: 1px solid black; padding: 5px;"> <p style="text-align: center; background-color: #ccc; margin: 0;">Types</p> <ul style="list-style-type: none"> 30-P2126PA050NB-L287F69Y </div>	<div style="border: 1px solid black; padding: 5px; margin-bottom: 5px;"> <p style="text-align: center; background-color: #ccc; margin: 0;"><i>flow</i> 2 17mm housing</p>  </div> <div style="border: 1px solid black; padding: 5px;"> <p style="text-align: center; background-color: #ccc; margin: 0;">Schematic</p>  </div>

Maximum Ratings

$T_j=25^{\circ}\text{C}$, unless otherwise specified

Parameter	Symbol	Condition	Value	Unit
Inverter Switch				
Collector-emitter voltage	V_{CES}		1200	V
Collector current	I_{C}	$T_j=T_{j\text{max}}$ $T_s=80^{\circ}\text{C}$	74	A
Repetitive peak collector current	I_{CRM}	t_p limited by $T_{j\text{max}}$	300	A
Total power dissipation	P_{tot}	$T_j=T_{j\text{max}}$ $T_s=80^{\circ}\text{C}$	307	W
Gate-emitter voltage	V_{GES}		± 20	V
Maximum Junction Temperature	$T_{j\text{max}}$		175	$^{\circ}\text{C}$



Vincotech

Parameter	Symbol	Conditions	Value	Unit
Inverter Diode				
Peak Repetitive Reverse Voltage	V_{RRM}		1200	V
Continuous (direct) forward current	I_F	$T_j = T_{jmax}$ $T_h = 80^\circ\text{C}$	96	A
Repetitive peak forward current	I_{FRM}		200	A
Total power dissipation	P_{tot}	$T_j = T_{jmax}$ $T_h = 80^\circ\text{C}$	176	W
Maximum Junction Temperature	T_{jmax}		175	$^\circ\text{C}$

Module Properties

Parameter	Symbol	Conditions	Value	Unit
Thermal Properties				
Storage temperature	T_{stg}		-40...+125	$^\circ\text{C}$
Operation Junction Temperature	T_{jop}		-40...+($T_{jmax} - 25$)	$^\circ\text{C}$

Isolation Properties

Isolation voltage	V_{isol}	DC voltage	$t_p=2s$	4000	V
Creepage distance				min 12,7	mm
Clearance				min 12,7	mm
Comparative Tracking Index	CTI			>200	



Vincotech

Characteristic Values

Inverter Switch

Parameter	Symbol	Conditions				Value			Unit
		V_{GE} [V]	V_{CE} [V]	I_C [A]	T_j [°C]	Min	Typ	Max	

Static

Gate-emitter threshold voltage	$V_{GE(th)}$	$V_{CE}=V_{CE}$			0,0017	25 125	5,3	5,8	6,3	V
Collector-emitter saturation voltage	V_{CEsat}		15		100	25 125 150	1,58	1,88 2,26 3,79	2,07	V
Collector-emitter cut-off current	I_{CES}		0	1200		25 125			2	μA
Gate-emitter leakage current	I_{GES}		20	0		25 125			240	nA
Internal gate resistance	r_g							2		Ω
Input capacitance	C_{ies}	f=1MHz	0	25		25		5600		pF
Reverse transfer capacitance	C_{res}							200		

Thermal

Thermal resistance junction to sink	$R_{th(j-s)}$	Phase-Change Material $\lambda=3,4W/mK$						0,31		K/W
-------------------------------------	---------------	--	--	--	--	--	--	------	--	-----

IGBT Switching

Turn-on delay time	$t_{d(on)}$	$R_{goff} = 4 \Omega$ $R_{gon} = 4 \Omega$	± 15	600	100	25		104		ns
Rise time	t_r					150		108		
Turn-off delay time	$t_{d(off)}$					25		18		
Fall time	t_f					150		23		
						25		219		
Turn-on energy (per pulse)	E_{on}	$Q_{rFWD} = 9,3 \mu C$ $Q_{rFWD} = 18,7 \mu C$				25		4,040		mWs
Turn-off energy (per pulse)	E_{off}					150		6,729		
						25		5,249		
						150		8,769		



Vincotech

Inverter Diode

Parameter	Symbol	Conditions					Value			Unit
		V_r [V]	I_F [A]	T_j [°C]	Min	Typ	Max			

Static

Forward voltage	V_F				100	25 125 150		1,83 1,86 -	2,05	V
Reverse leakage current	I_r			1200		25 150			18 -	μ A

Thermal

Thermal resistance junction to sink	$R_{th(j-s)}$	Phase-Change Material $\lambda=3,4\text{W/mK}$						0,54		K/W
-------------------------------------	---------------	---	--	--	--	--	--	------	--	-----

FWD Switching

Peak recovery current	I_{RRM}	$di/dt = 6900\text{ A}/\mu\text{s}$ $di/dt = 5512\text{ A}/\mu\text{s}$	± 15	600	100	25		164		A
Reverse recovery time	t_{rr}					150		187		ns
Recovered charge	Q_r					25		130		μ C
Reverse recovered energy	E_{rec}					150		294		mWs
Peak rate of fall of recovery current	$(di_{rr}/dt)_{max}$					25		9,320		A/ μ s
						150		18,656		
								3,869		
								7,956		
								8743		
								3702		

Thermistor

Parameter	Symbol	Conditions					Value			Unit
		V_{CE} [V]	V_{CE} [V]	I_C [A]	T_j [°C]	Min	Typ	Max		
Rated resistance	R				25		22		k Ω	
Deviation of R100	$\Delta_{R/R}$	R100=1486 Ω			100	-12		+12	%	
Power dissipation	P				25		200		mW	
Power dissipation constant					25		2		mW/K	
B-value	$B_{(25/50)}$	Tol. $\pm 3\%$			25		3950		K	
B-value	$B_{(25/100)}$	Tol. $\pm 3\%$			25		3998		K	
Vincotech NTC Reference								B		



Vincotech

Inverter Switch Characteristics

Typical output characteristics IGBT

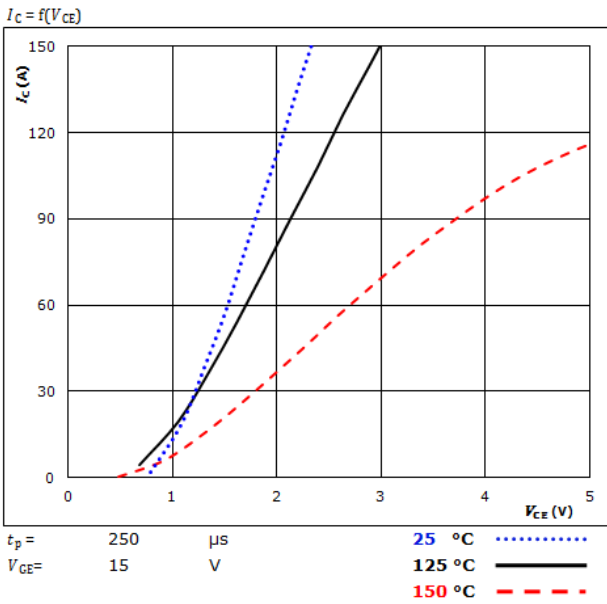

Typical output characteristics IGBT

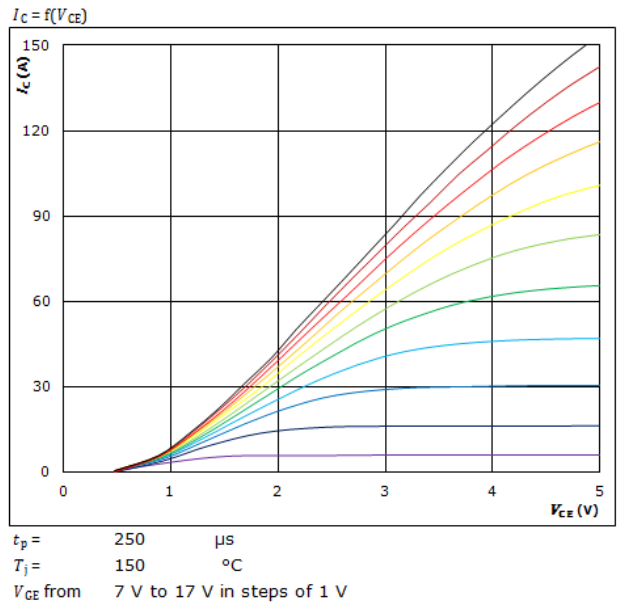

Typical transfer characteristics IGBT

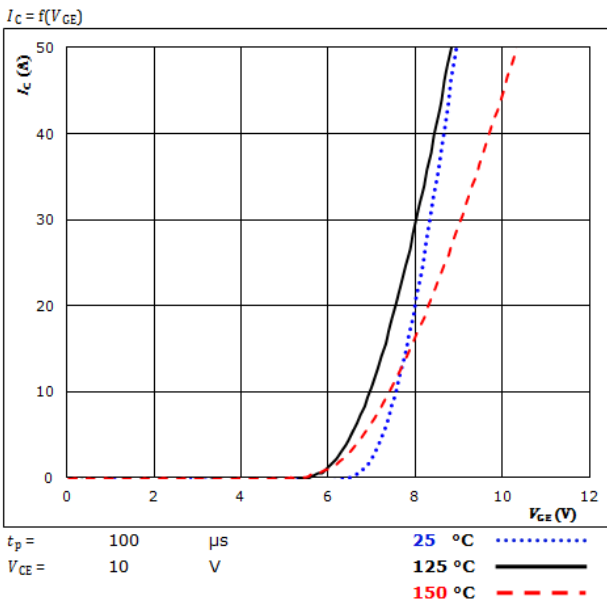

Transient Thermal Impedance as function of Pulse duration IGBT

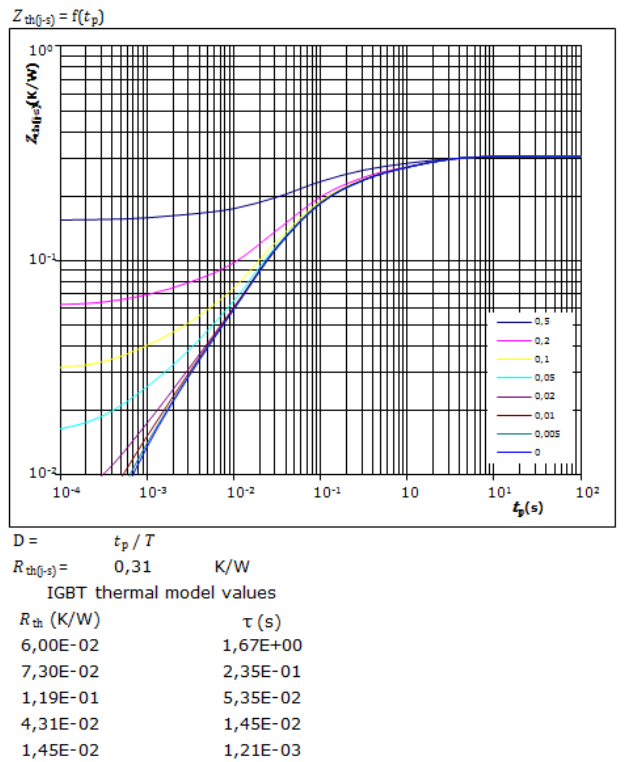



Vincotech

Inverter Diode Characteristics

Typical forward characteristics FWD

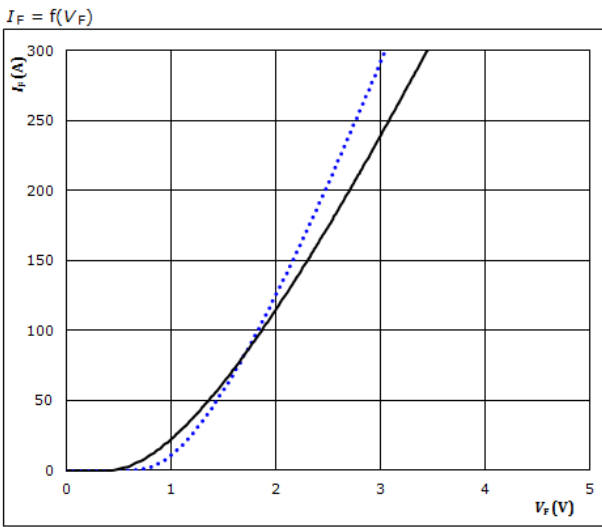

Transient thermal impedance as a function of pulse width FWD

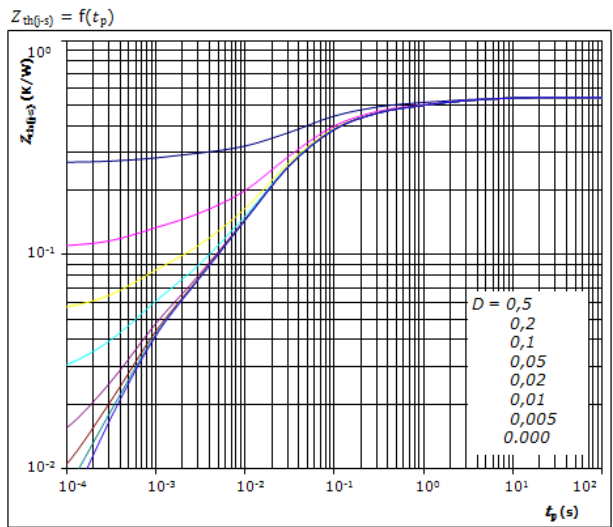

FWD thermal model values

R (K/W)	τ (s)
3,25E-02	4,14E+00
5,01E-02	9,90E-01
1,38E-01	1,45E-01
2,22E-01	3,37E-02
5,69E-02	9,51E-03
3,92E-02	7,97E-04
3,26E-02	5,37E-04

Thermistor Characteristics

Thermistor typical temperature characteristic

Typical NTC characteristic
as a function of temperature

$R_T = f(T)$

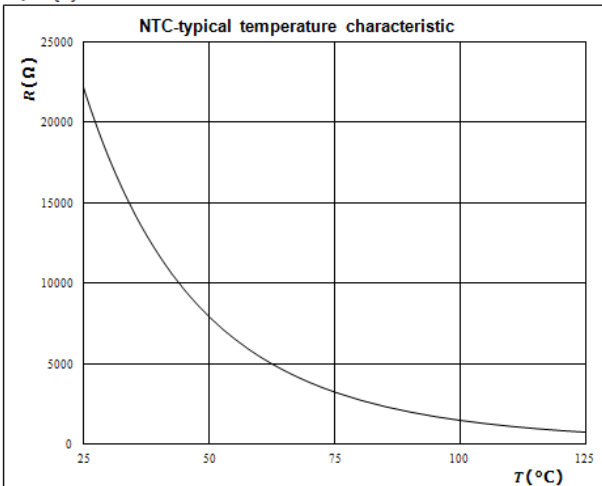



Inverter Switching Characteristics

Figure 1. IGBT
Typical switching energy losses as a function of collector current

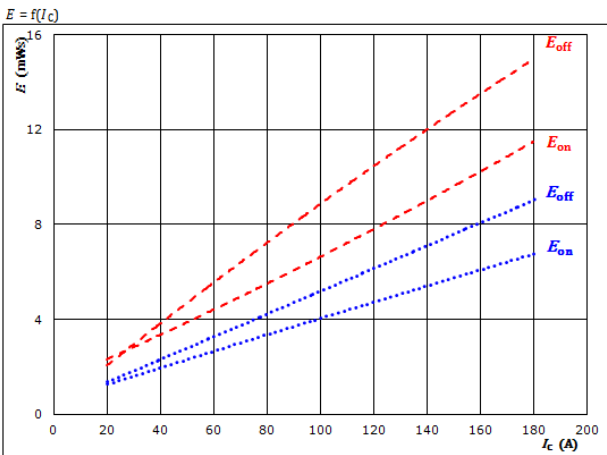

With an inductive load at
 $V_{CE} = 600 \text{ V}$
 $V_{GE} = \pm 15 \text{ V}$
 $R_{gon} = 4 \ \Omega$
 $R_{goff} = 4 \ \Omega$

T_j : 25 °C (blue dotted), 125 °C (black solid), 150 °C (red dashed)

Figure 2. IGBT
Typical switching energy losses as a function of gate resistor

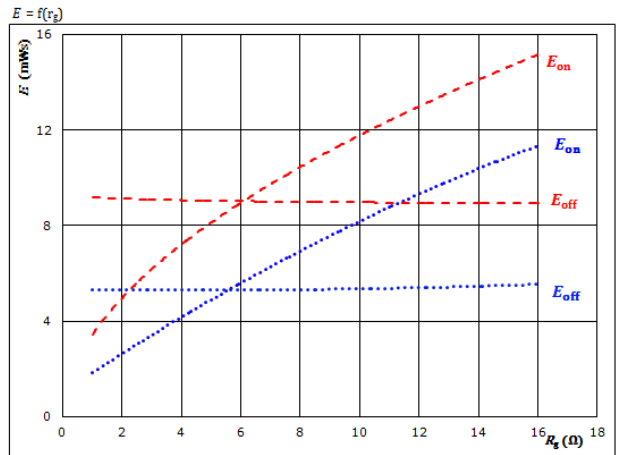

With an inductive load at
 $V_{CE} = 600 \text{ V}$
 $V_{GE} = \pm 15 \text{ V}$
 $I_C = 100 \text{ A}$

T_j : 25 °C (blue dotted), 125 °C (black solid), 150 °C (red dashed)

Figure 3. FWD
Typical reverse recovered energy loss as a function of collector current

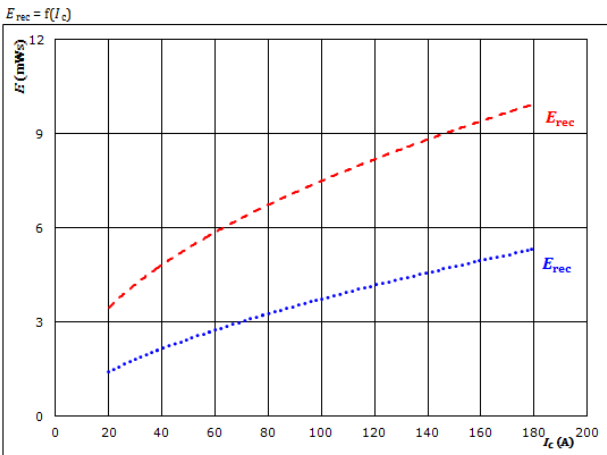

With an inductive load at
 $V_{CE} = 600 \text{ V}$
 $V_{GE} = \pm 15 \text{ V}$
 $R_{gon} = 4 \ \Omega$

T_j : 25 °C (blue dotted), 125 °C (black solid), 150 °C (red dashed)

Figure 4. FWD
Typical reverse recovered energy loss as a function of gate resistor

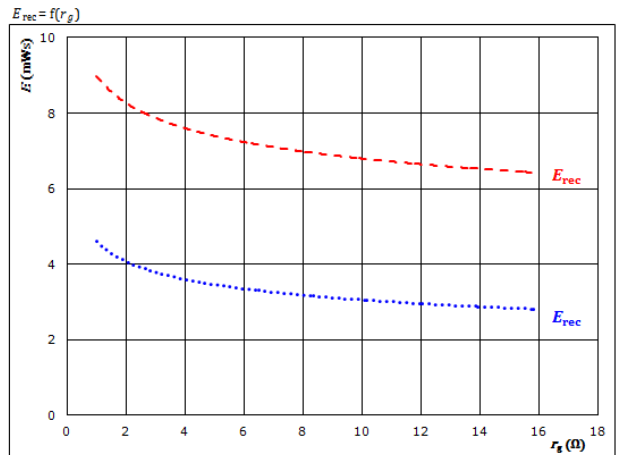

With an inductive load at
 $V_{CE} = 600 \text{ V}$
 $V_{GE} = \pm 15 \text{ V}$
 $I_C = 100 \text{ A}$

T_j : 25 °C (blue dotted), 125 °C (black solid), 150 °C (red dashed)



Inverter Switching Characteristics

Figure 5. IGBT

Typical switching times as a function of collector current

$$t = f(I_C)$$

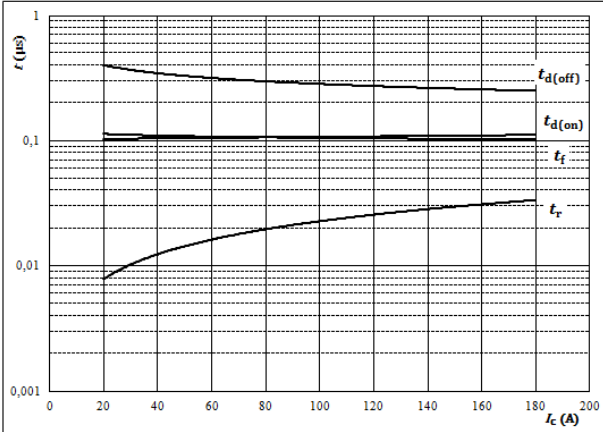

With an inductive load at

$T_j =$	150	$^{\circ}C$
$V_{CE} =$	600	V
$V_{GE} =$	± 15	V
$R_{gon} =$	4	Ω
$R_{goff} =$	4	Ω

Figure 6. IGBT

Typical switching times as a function of gate resistor

$$t = f(r_g)$$

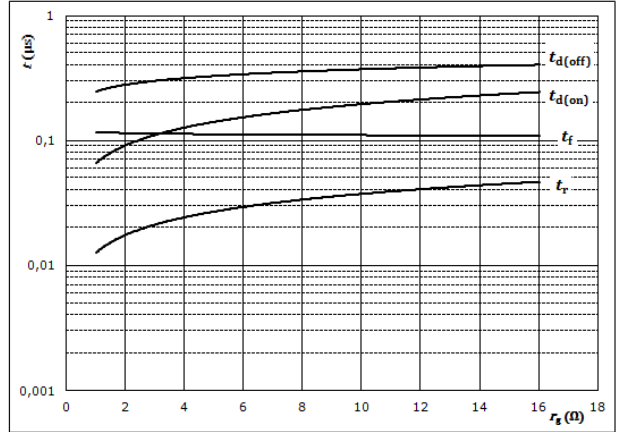

With an inductive load at

$T_j =$	150	$^{\circ}C$
$V_{CE} =$	600	V
$V_{GE} =$	± 15	V
$I_C =$	100	A

Figure 7. FWD

Typical reverse recovery time as a function of collector current

$$t_{rr} = f(I_C)$$

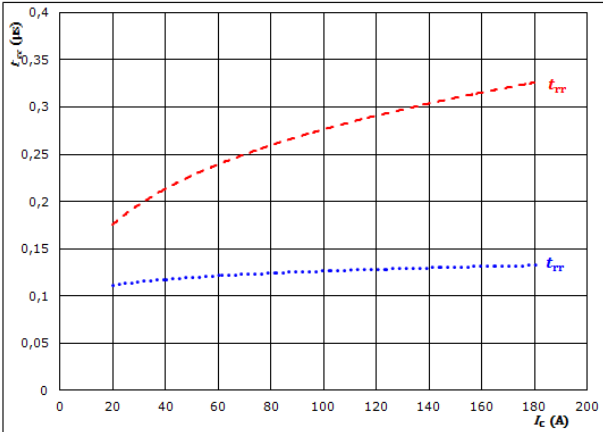

At	$V_{CE} =$	600	V	$T_j:$	25 $^{\circ}C$
	$V_{GE} =$	± 15	V		125 $^{\circ}C$	————
	$R_{gon} =$	4	Ω		150 $^{\circ}C$	-----

Figure 8. FWD

Typical reverse recovery time as a function of IGBT turn on gate resistor

$$t_{rr} = f(R_{gon})$$

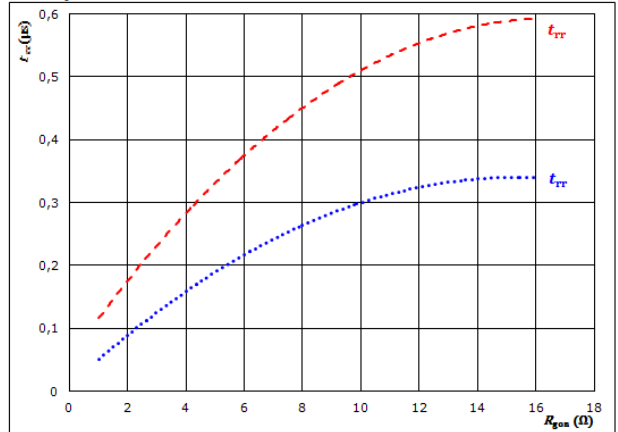

At	$V_{CE} =$	600	V	$T_j:$	25 $^{\circ}C$
	$V_{GE} =$	± 15	V		125 $^{\circ}C$	————
	$I_C =$	100	A		150 $^{\circ}C$	-----



Inverter Switching Characteristics

Figure 9. FWD
Typical recovered charge as a function of collector current

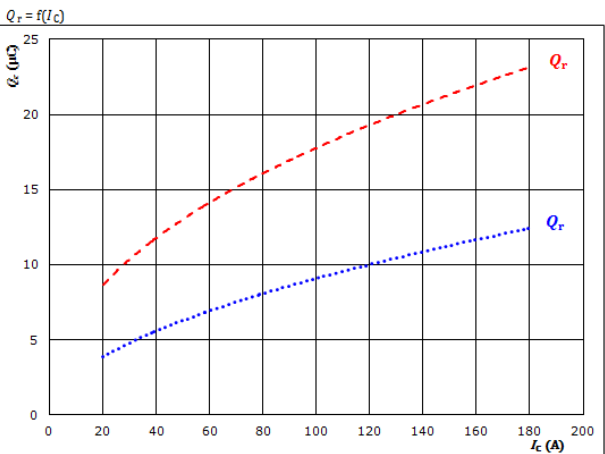

At $V_{CE} = 600$ V
 $V_{GE} = \pm 15$ V
 $R_{gon} = 4$ Ω
 T_j : 25 °C (dotted), 125 °C (solid), 150 °C (dashed)

Figure 10. FWD
Typical recovered charge as a function of IGBT turn on gate resistor

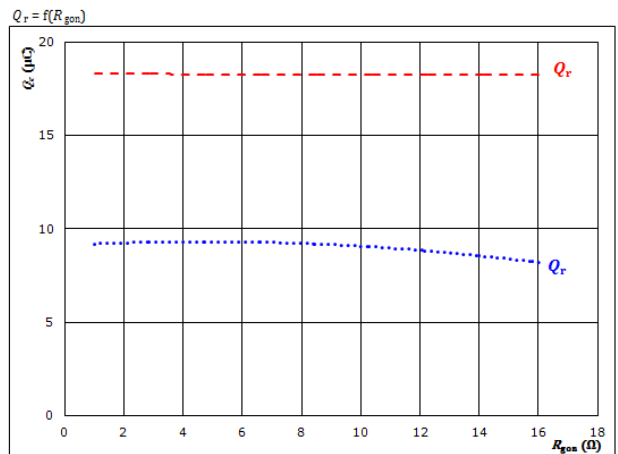

At $V_{CE} = 600$ V
 $V_{GE} = \pm 15$ V
 $I_c = 100$ A
 T_j : 25 °C (dotted), 125 °C (solid), 150 °C (dashed)

Figure 11. FWD
Typical peak reverse recovery current current as a function of collector current

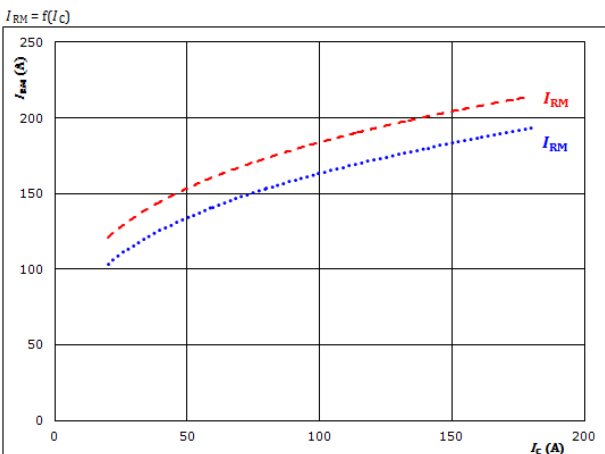

At $V_{CE} = 600$ V
 $V_{GE} = \pm 15$ V
 $R_{gon} = 4$ Ω
 T_j : 25 °C (dotted), 125 °C (solid), 150 °C (dashed)

Figure 12. FWD
Typical peak reverse recovery current as a function of IGBT turn on gate resistor

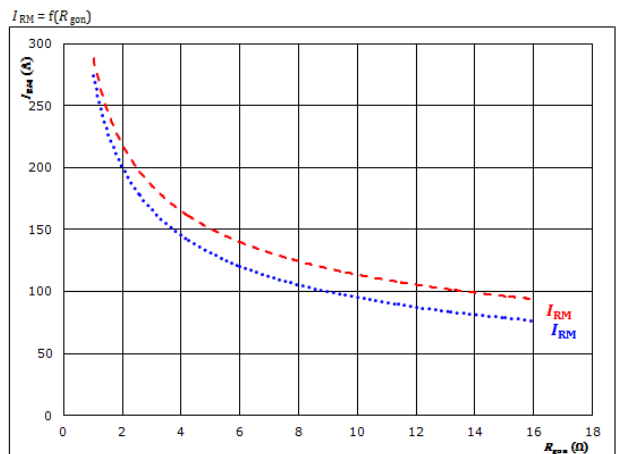

At $V_{CE} = 600$ V
 $V_{GE} = \pm 15$ V
 $I_c = 100$ A
 T_j : 25 °C (dotted), 125 °C (solid), 150 °C (dashed)



Vincotech

Inverter Switching Characteristics

Figure 13. FWD

Typical rate of fall of forward and reverse recovery current as a function of collector current
 $di_F/dt, di_{rr}/dt = f(I_C)$

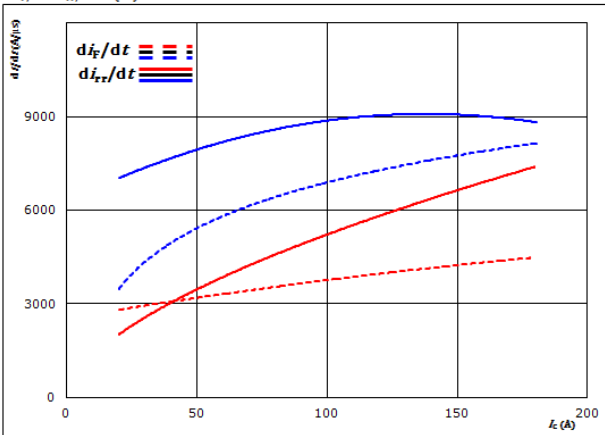

At $V_{CE} = 600$ V
 $V_{CE} = \pm 15$ V
 $R_{gon} = 4$ Ω
 $T_j = 25$ °C
 125 °C
 150 °C

Figure 14. FWD

Typical rate of fall of forward and reverse recovery current as a function of IGBT turn on gate resistor
 $di_F/dt, di_{rr}/dt = f(R_g)$

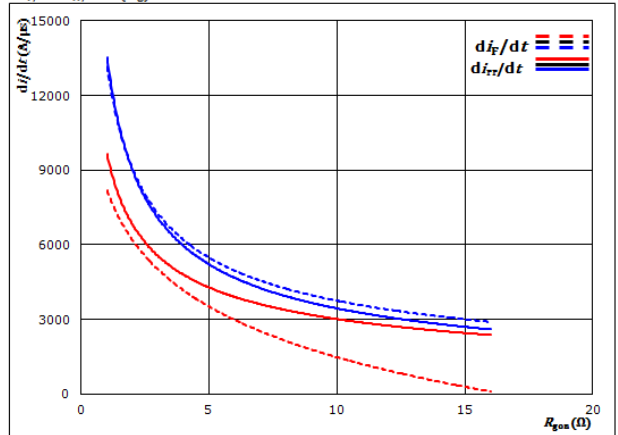

At $V_{CE} = 600$ V
 $V_{CE} = \pm 15$ V
 $I_C = 100$ A
 $T_j = 25$ °C
 125 °C
 150 °C

Figure 15. IGBT

Reverse bias safe operating area

$I_C = f(V_{CE})$

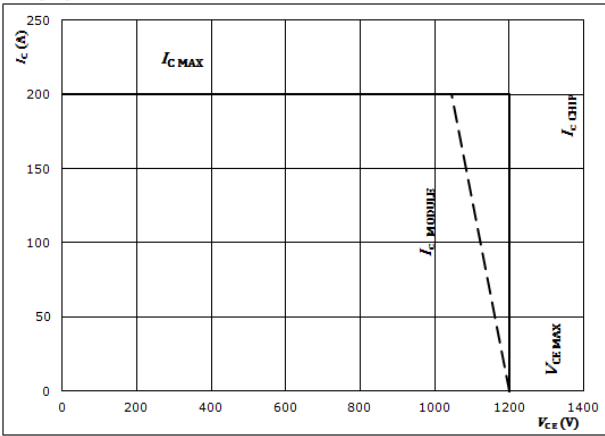

At $T_j = 175$ °C
 $R_{gon} = 4$ Ω
 $R_{goff} = 4$ Ω



Inverter Switching Definitions

General conditions

T_j	=	150 °C
R_{gon}	=	4 Ω
R_{goff}	=	4 Ω

Figure 1. IGBT
Turn-off Switching Waveforms & definition of t_{doff} , t_{Eoff} (t_{Eoff} = integrating time for Eoff)

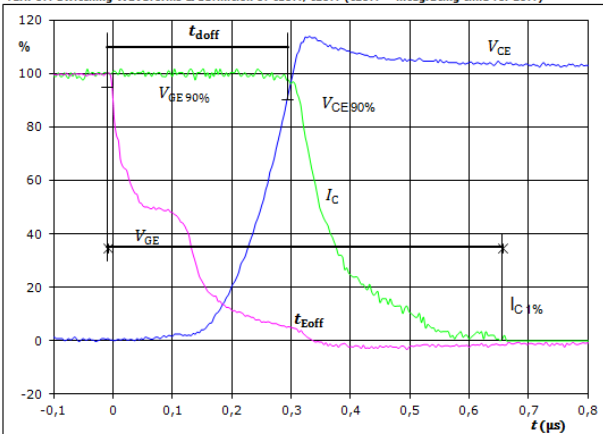

$V_{CE}(0\%) =$	-15	V
$V_{CE}(100\%) =$	15	V
$V_C(100\%) =$	600	V
$I_C(100\%) =$	100	A
$t_{doff} =$	0,293	μs
$t_{Eoff} =$	0,665	μs

Figure 2. IGBT
Turn-on Switching Waveforms & definition of t_{don} , t_{Eon} (t_{Eon} = integrating time for Eon)

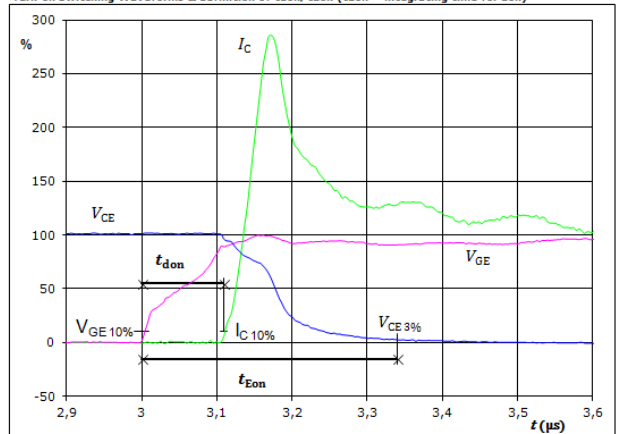

$V_{CE}(0\%) =$	-15	V
$V_{CE}(100\%) =$	15	V
$V_C(100\%) =$	600	V
$I_C(100\%) =$	100	A
$t_{don} =$	0,108	μs
$t_{Eon} =$	0,339	μs

Figure 3. IGBT
Turn-off Switching Waveforms & definition of t_f

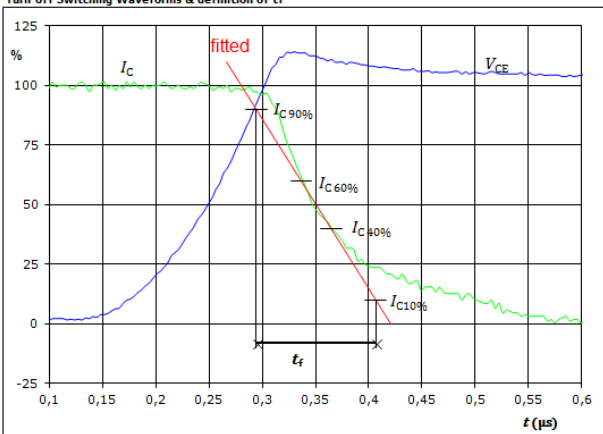

$V_C(100\%) =$	600	V
$I_C(100\%) =$	100	A
$t_f =$	0,111	μs

Figure 4. IGBT
Turn-on Switching Waveforms & definition of t_r

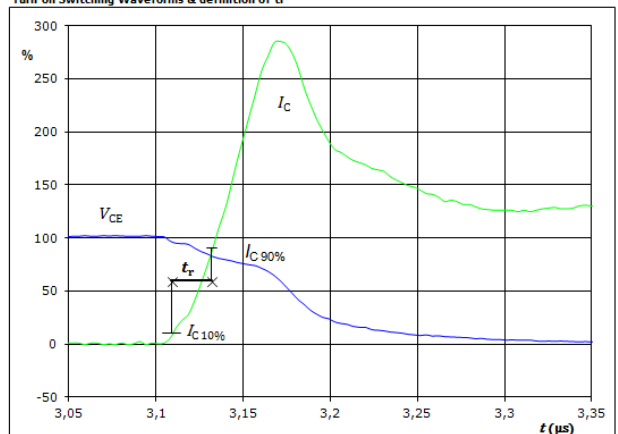

$V_C(100\%) =$	600	V
$I_C(100\%) =$	100	A
$t_r =$	0,023	μs



Vincotech

Inverter Switching Definitions

Figure 5. IGBT

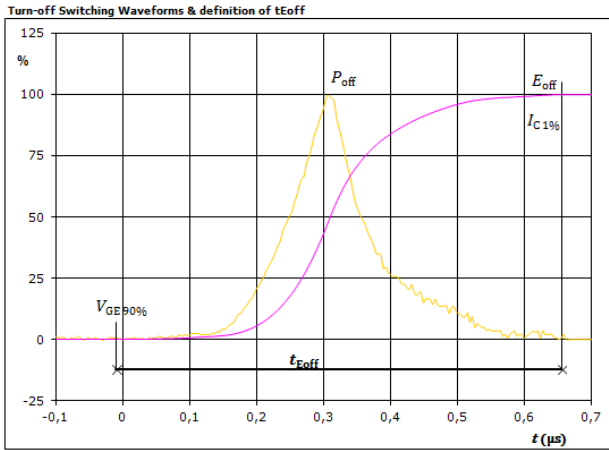

$P_{off}(100\%) =$	60,25	kW
$E_{off}(100\%) =$	8,77	mJ
$t_{Eoff} =$	0,67	µs

Figure 6. IGBT

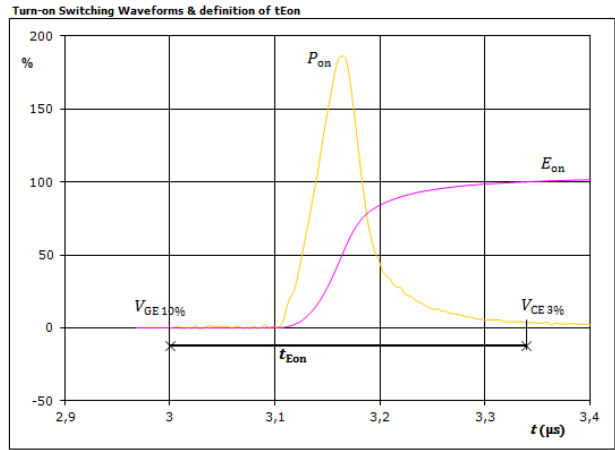

$P_{on}(100\%) =$	60,25	kW
$E_{on}(100\%) =$	6,73	mJ
$t_{Eon} =$	0,34	µs

Figure 7. FWD

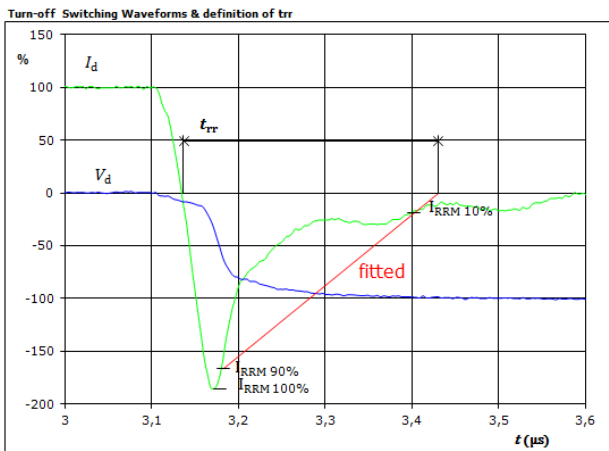

$V_d(100\%) =$	600	V
$I_d(100\%) =$	100	A
$I_{RRM}(100\%) =$	-187	A
$t_{rr} =$	0,294	µs



Inverter Switching Definitions

Figure 8. FWD

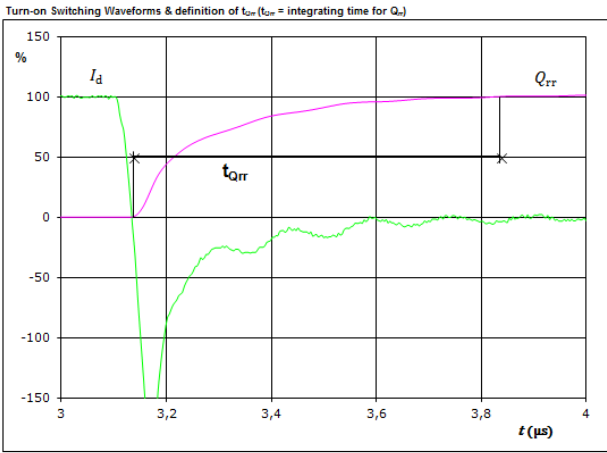

$I_d(100\%) =$	100	A
$Q_{rr}(100\%) =$	18,66	μC
$t_{Qrr} =$	0,70	μs

Figure 9. FWD

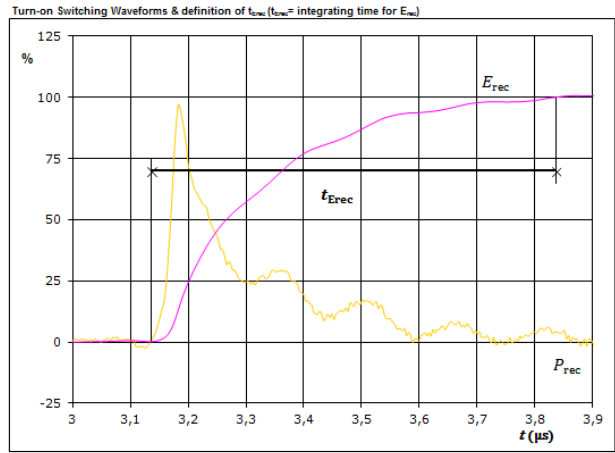

$P_{rec}(100\%) =$	60,25	kW
$E_{rec}(100\%) =$	7,96	mJ
$t_{Erec} =$	0,70	μs



Vincotech

Ordering Code & Marking							
Version	Ordering Code	in DataMatrix as	in packaging barcode as				
without thermal paste 17mm housing	30-P2126PA050NB-L287F69Y	L287F69Y	L287F69Y				
with thermal paste 17mm housing	30-P2126PA050NB-L287F69Y-/3/	L287F69Y-/3/	L287F69Y-/3/				
NN-NNNNNNNNNNNNNN NNNNNNNN WWYY UL Vinco LLLLL SSSS		Text	Name	Date code	UL & Vinco	Lot	Serial
			NN-NNNNNNNNNNNNNN-NNNNNNNN	WWYY	UL Vinco	LLLLL	SSSS
		Datamatrix	Type&Ver	Lot number	Serial	Date code	
		TTTTTTTV	LLLLL	SSSS	WWYY		

Outline							
Pin table [mm]				Pin table [mm]			
Pin	X	Y	Function	Pin	X	Y	Function
1	0,9	0	S11	30	68,5	0	DC+3
2	0,9	3	G11	31	68,5	2,7	DC+3
3	3,9	0	DC-1	32	64,7	36	G16
4	3,9	2,7	DC-1	33	61,7	36	S16
5	3,9	5,4	DC-1	34	58,7	36	PH3
6	6,6	0	DC-1	35	56	36	PH3
7	15,2	0	DC+1	36	53,3	36	PH3
8	15,2	2,7	DC+1	37	50,6	36	PH3
9	17,9	0	DC+1	38	39,4	36	G14
10	17,9	2,7	DC+1	39	36,4	36	S14
11	26,2	0	S13	40	33,4	36	PH2
12	26,2	3	G13	41	30,7	36	PH2
13	29,2	0	DC-2	42	28	36	PH2
14	29,2	2,7	DC-2	43	25,3	36	PH2
15	29,2	5,4	DC-2	44	14,1	36	G12
16	31,9	0	DC-2	45	11,1	36	S12
17	32,2	4,05	NTC	46	8,1	36	PH1
18	40,5	0	DC+2	47	5,4	36	PH1
19	40,5	2,7	DC+2	48	2,7	36	PH1
20	43,2	0	DC+2	49	0	36	Ph1
21	43,2	2,7	DC+2				
22	51,5	0	S15				
23	51,5	3	G15				
24	54,5	0	DC-3				
25	54,5	2,7	DC-3				
26	54,5	5,4	DC-3				
27	57,2	0	DC-3				
28	65,8	0	DC+3				
29	65,8	2,7	DC+3				



Vincotech

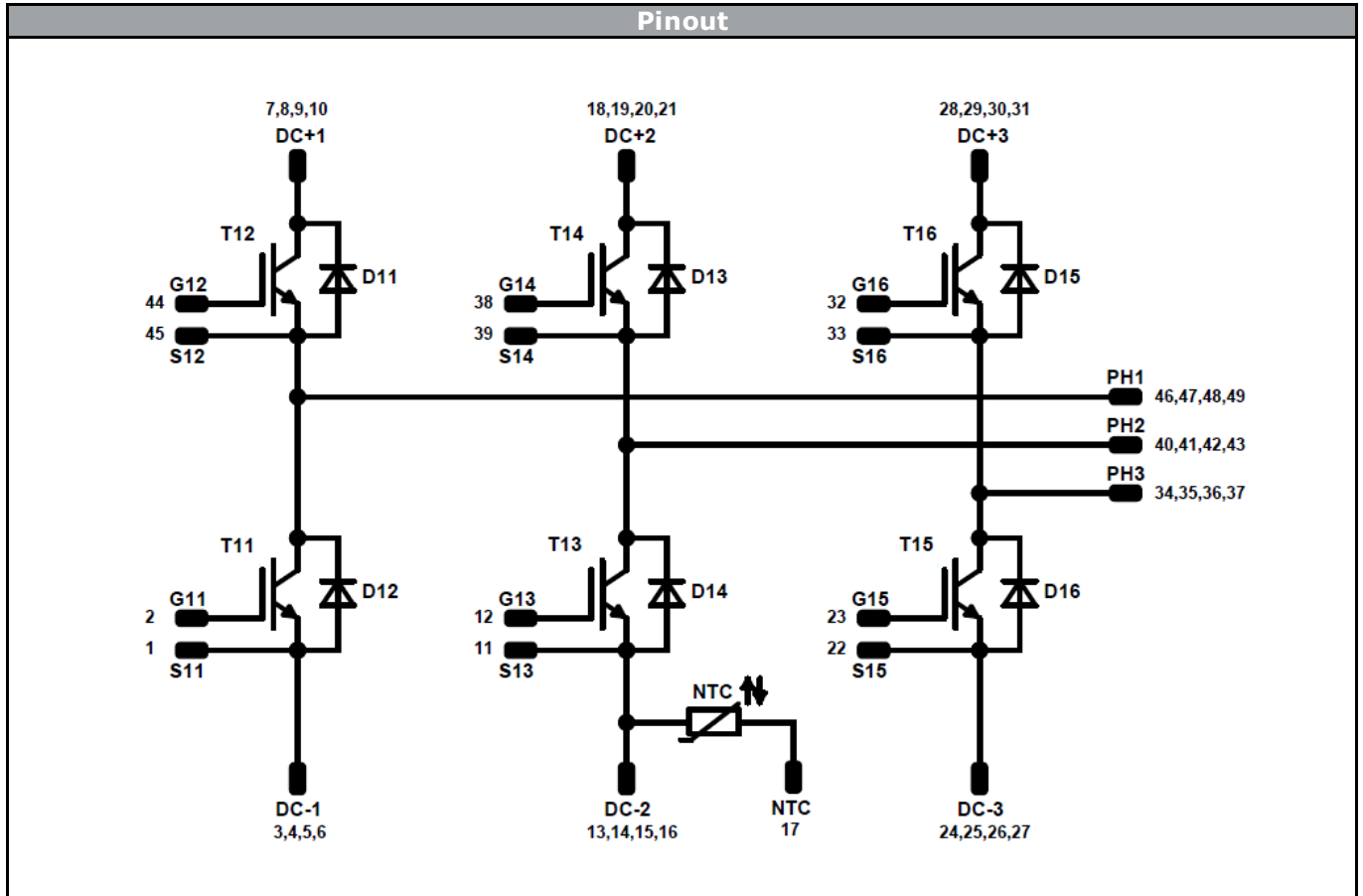

Identification					
ID	Component	Voltage	Current	Function	Comment
T11,T12,T13,T14,T15, T16	IGBT	1200V	50A	Inverter Switch	CH0050C-1200S002
D11,D12,D13,D14,D15, D16	FWD	1200V	50A	Inverter Diode	CH0050R-1200S002
NTC	NTC	-	-	Thermistor	



Vincotech

Packaging instruction					
Standard packaging quantity (SPQ)	42	>SPQ	Standard	<SPQ	Sample

Handling instruction	
Handling instructions for <i>flow</i> 2 packages see vincotech.com website.	

Document No.:	Date:	Modification:	Pages
30-P2126PA050NB-287F69Y-D1-14	01 Jun. 2015		

DISCLAIMER

The information, specifications, procedures, methods and recommendations herein (together "information") are presented by Vincotech to reader in good faith, are believed to be accurate and reliable, but may well be incomplete and/or not applicable to all conditions or situations that may exist or occur. Vincotech reserves the right to make any changes without further notice to any products to improve reliability, function or design. No representation, guarantee or warranty is made to reader as to the accuracy, reliability or completeness of said information or that the application or use of any of the same will avoid hazards, accidents, losses, damages or injury of any kind to persons or property or that the same will not infringe third parties rights or give desired results. It is reader's sole responsibility to test and determine the suitability of the information and the product for reader's intended use.

LIFE SUPPORT POLICY

Vincotech products are not authorised for use as critical components in life support devices or systems without the express written approval of Vincotech.

As used herein:

1. Life support devices or systems are devices or systems which, (a) are intended for surgical implant into the body, or (b) support or sustain life, or (c) whose failure to perform when properly used in accordance with instructions for use provided in labelling can be reasonably expected to result in significant injury to the user.
2. A critical component is any component of a life support device or system whose failure to perform can be reasonably expected to cause the failure of the life support device or system, or to affect its safety or effectiveness.