

Powered by



# MSJ 1000 ▶ 2V 1020 Ah

MSJ 1000 is a long service life battery up to 20 years expected life under normal float charge. As with all CSB batteries, all are rechargeable, highly efficient, leak proof and maintenance free.



CSB-manufactured **VRLA** (Absorbent Glass Mat type) batteries are UL-recognized components under UL1989.

CSB is also certified by ISO 9001 and ISO 14001.

## ► Specification

Cells Per Unit	1
Voltage Per Unit	2
Capacity	1020Ah @ 10hr-rate to 1.80V per cell @25°C (77°F)
Weight	Approx. 72.8 kg (160.5 lbs)
Maximum Discharge Current	6000A(5sec)
Internal Resistance	Approx. 0.28 mΩ
Operating Temperature Range	Discharge: -20°C~50°C (-4°F~122°F) Charge: 0°C~40°C (32°F~104°F) Storage: -20°C~40°C (-4°F~104°F)
Nominal Operating Temperature Range	25°C±3°C (77°F±5°F)
Float Charging Voltage	2.23±0.02/Cell at 25°C (77°F) Temp. Coefficient ±3.3mV/°C (±1.8mV/°F)
Recommended Maximum Charging Current Limit	300A
Equalization / Cycle Use Charging Voltage	2.35V Temps coefficient ±3.3mV/°C (±1.8mV/°F)
Terminal	Pb-Ca-Sn Alloy Recessed Terminal
Container Material	The container and cover are made of flame retardant plastics which meet ABS(UL 94-V0) specifications. The oxygen index level is higher than 28

## ► Dimensions :

Unit: mm (inch)

Overall Height (H)	Container height (h)	Length (L)	Width (W)
339±2.5 (13.35±0.10)	331±2.5 (13.03±0.10)	471±2.5 (18.54±0.10)	171±2 (6.73±0.08)

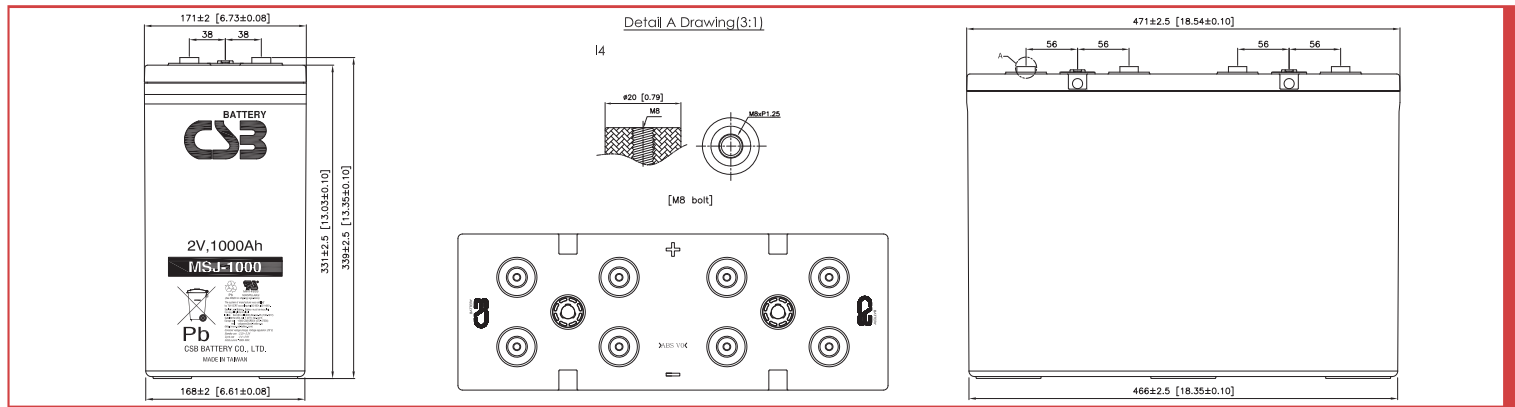

## Constant Current Discharge Characteristics Unit:A (25°C, 77°F)

F.V/Time	15MIN	30MIN	60MIN	2HR	3HR	4HR	5HR	6HR	8HR	10HR
1.60V	1853	1241	760	435.2	311.9	241.2	196.7	166.5	130.2	107.7
1.67V	1660	1179	740	430.0	308.7	238.6	194.7	164.9	129.1	106.9
1.70V	1561	1139	726	426.4	306.5	237.0	193.5	164.0	128.5	106.4
1.75V	1403	1038	691	416.7	301.1	232.7	190.3	161.5	126.7	105.0
1.80V	1201	919	637	398.5	290.4	224.8	184.3	157.0	123.3	102.3
1.83V	1061	843	596	381.3	279.0	216.8	178.2	152.3	119.8	99.4

## Constant Power Discharge Characteristics Unit:W (25°C, 77°F)

F.V/Time	15MIN	30MIN	60MIN	2HR	3HR	4HR	5HR	6HR	8HR	10HR
1.60V	3245	2251	1381	830.8	595.3	469.7	390.2	334.5	256.2	200.5
1.67V	3016	2165	1355	822.7	590.4	466.6	387.9	332.5	254.3	199.1
1.70V	2897	2109	1335	817.0	587.0	464.3	386.1	331.1	253.0	198.2
1.75V	2647	1971	1280	800.3	577.5	458.2	381.4	327.1	249.3	195.5
1.80V	2374	1780	1194	768.6	559.1	446.1	371.8	319.1	241.8	189.9
1.83V	2139	1660	1126	737.9	540.6	433.6	361.6	310.9	234.3	184.0

Ratings presented herein are subject to revision without notice. Please refer to [www.csb-battery.com](http://www.csb-battery.com) to confirm the latest version.

### Expected Life V.S Operating Temperature

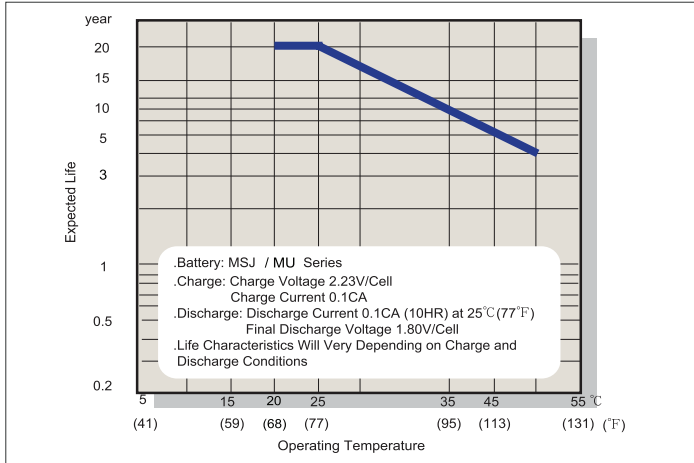

### Typical Constant Voltage Charge Characteristics

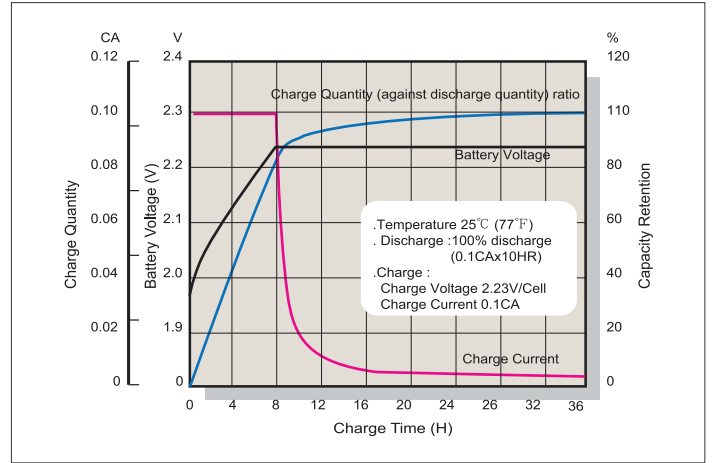

### Capacity Retention Characteristics

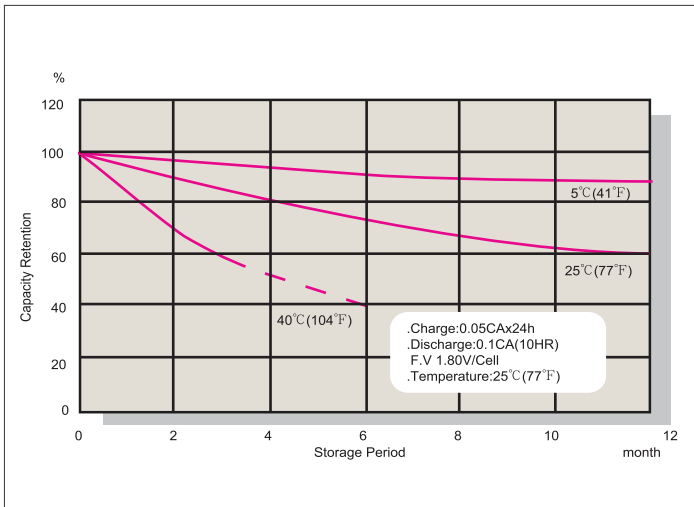

### Discharge Characteristics

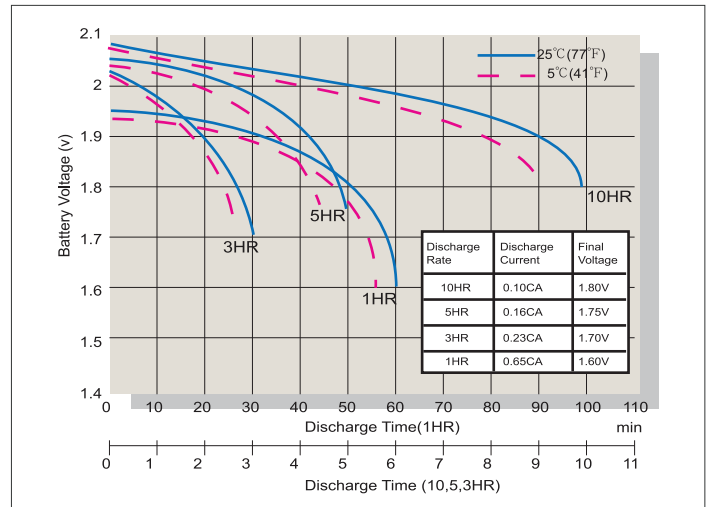

### Oxygen Recombination Efficiency Chart

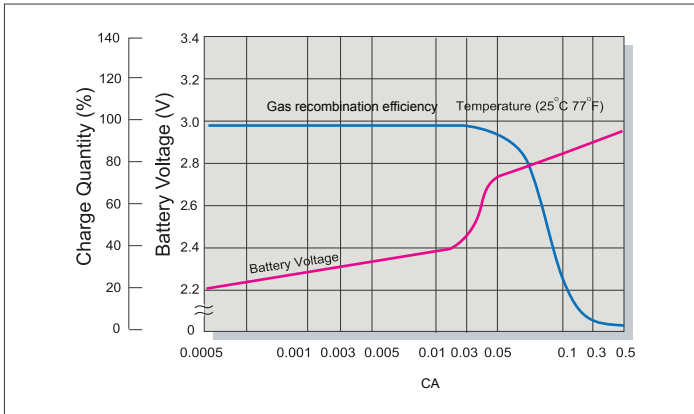

### Terminal Voltage (V) and Discharge Time 25°C (77°F)

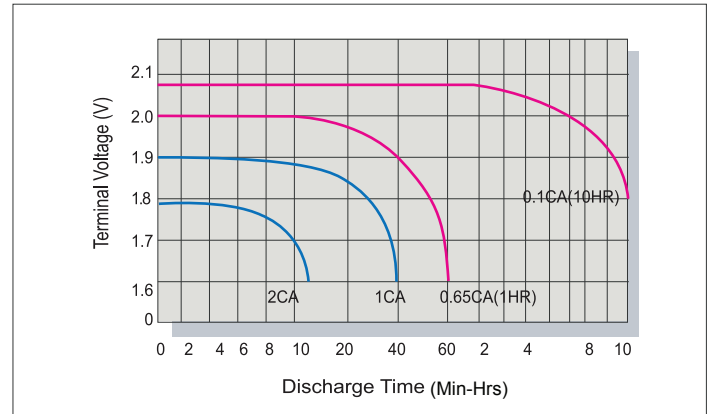

### Charging Procedures

Application	Charge Voltage (V/Cell)			Max. Charge Current
	Temperature	Set Point	Allowable Range	
Standby	25°C (77°F)	2.23	2.21~2.25	0.3C

### Discharge Current VS. Discharge Voltage

Discharge Current (A)	Final Discharge Voltage (V/Cell)
0.05C > A	1.90
0.15C > A ≥ 0.05C	1.80
0.20C > A ≥ 0.15C	1.75
0.40C > A ≥ 0.20C	1.70
A > 0.40C	1.60

Sales Office URL: [WWW.CSB-BATTERY.COM](http://WWW.CSB-BATTERY.COM)

### GLOBAL HQ CSB BATTERY CO., LTD. (TAIWAN)

Tel : +886-2-2880-5600  
 Fax : +886-2-2888-3300  
 mail : [service@csb-battery.com.tw](mailto:service@csb-battery.com.tw)

### BEIJING OFFICE. (CHINA)

CSB BATTERY TECHNOLOGIES (BEIJING) CO., LTD.  
 Tel : +86-10-5820-5336/5338  
 Fax : +86-10-58203053  
 mail : [chinasls@csb-battery.com](mailto:chinasls@csb-battery.com)

### AMERICA HQ

CSB BATTERY TECHNOLOGIES INC. (U.S.A)  
 Tel : +1-817-244-7777/1-(800)3-CSB-USA(272872)  
 Fax : +1-817-244-4445  
 mail : [csb@csb-battery.com](mailto:csb@csb-battery.com)

### SHANGHAI OFFICE. (CHINA)

CSB BATTERY LOGISTIC (SHANGHAI) CO., LTD.  
 Tel : +86-21-5046-1622/5046-0833  
 Fax : +86-21-5064-1046  
 mail : [chinasls@csb-battery.com](mailto:chinasls@csb-battery.com)

### EUROPE HQ

CSB Battery Europe BV.  
 Tel : +31(0)-180-418-140  
 Fax : +31(0)-180-418-327  
 mail : [eurosales@csb-battery.eu](mailto:eurosales@csb-battery.eu)

### SHENZHEN OFFICE. (CHINA)

CSB BATTERY LOGISTIC ( SHANGHAI ) CO., LTD.  
 Tel : +86-755-8831-6488/6396/6356  
 Fax : +86-755-8831-6548  
 mail : [she@csb-battery.com.cn](mailto:she@csb-battery.com.cn)