

**Input**

Rated input voltage	100 V ~ 240 V ac
Input voltage range	90 V ~ 264 V ac
Rated frequency	50~60 Hz
Frequency range	47~63 Hz
Rated input current	300 mA RMS max.
Inrush current	30 A max. at 115 / 50 A max. at 230 V ac cool start

Output

Output voltage	9 V dc at 1.33 A
Output min. current	0 A
Line regulation	± 1%
Load regulation	± 5%
Over voltage protection	11.4 ~ 12.6 V dc max. (output shut down)
Short circuit protection	output shut down and auto restart
Ripple voltage	150 mV (p-p) (100~240 V ac at full load)
Efficiency	60% min.

Safety and EMI

HI-POT	input to output	3000 V ac or 4242 V dc at 10 mA for 1 min.
Insulation resistance	input to output	> 100 M Ohm at 500 V dc
Safety approvals	UL/cUL, S/GS, CE	
EMI standard	meets FCC class B, CE, VCCI-II	
RoHS compliant	yes	
Leakage current	0.25 mA	

Environmental

Storage temperature	-10°C ~ +70° C
Operating temperature	0°C ~ +40° C
Storage humidity	10~90%
Operating humidity	20~80%

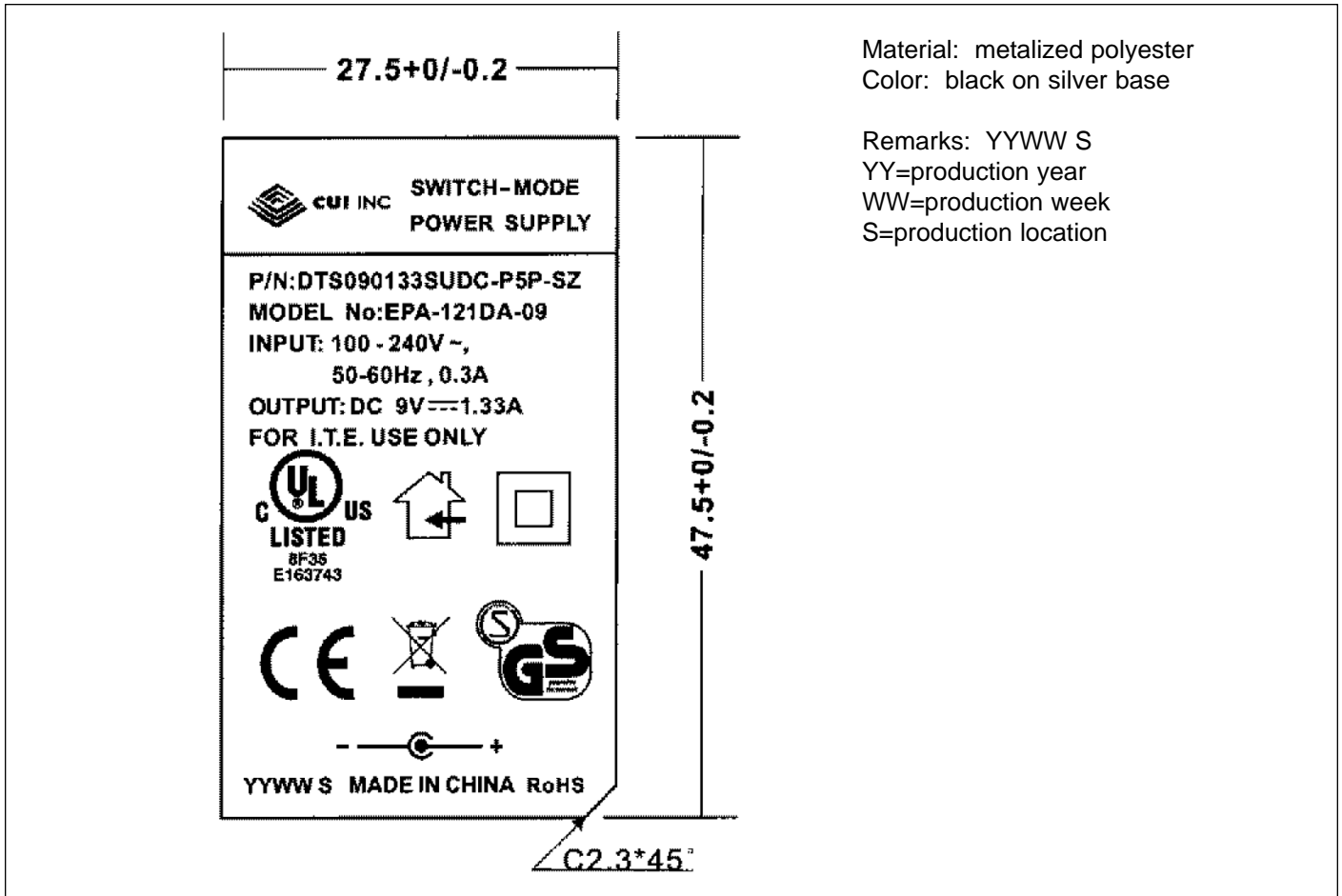
Label

Material: metalized polyester

Color: black on silver base

Remarks: YYWW S

YY=production year

WW=production week

S=production location



Mechanical Drawing

Tolerance: ± 1

Input plug
Case size

Inlet IEC320/C8-2 Type
75 L x 47.5 W x 26.5 H mm

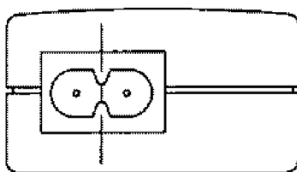
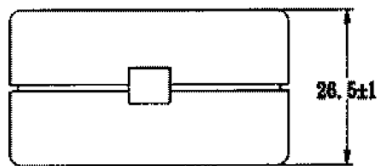
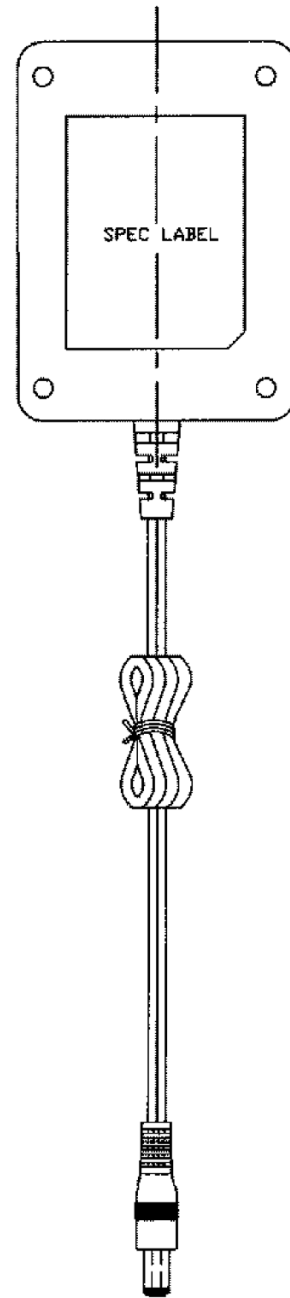
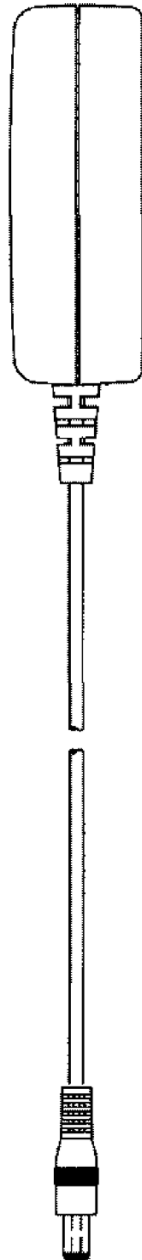
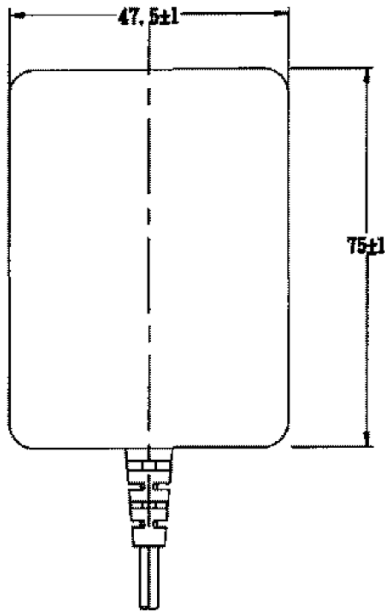



DC Cord

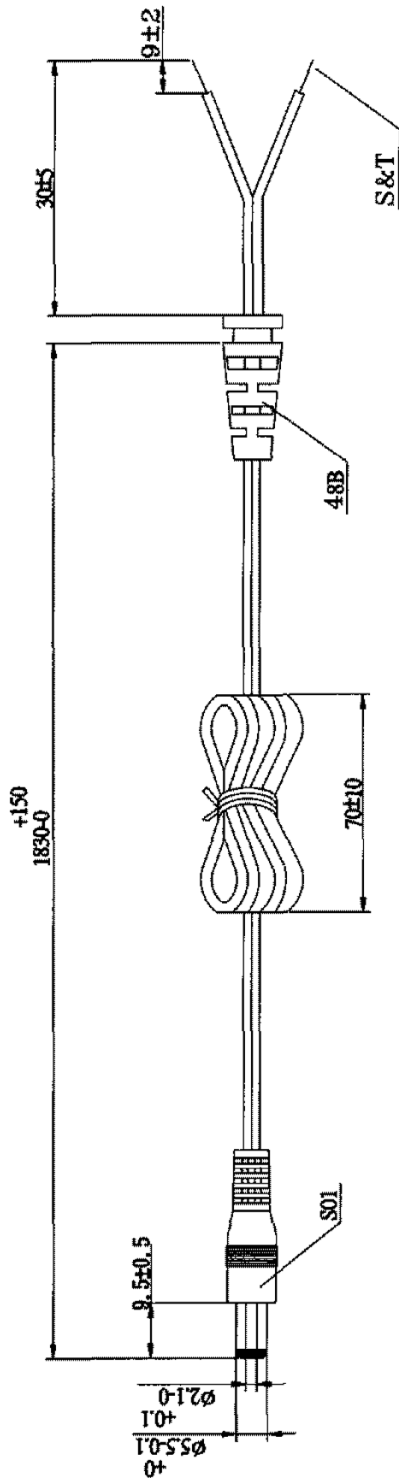

HAVE ON WORD WIRE IN OUTER, NO WORD WIRE IN INNER

#20AWG X2C UL2468

OD: Ø1.9X3.8



VIBRATION TEST	a. 360°
	b. WEIGHT 200g
	c. 40 ROUND/MINUTE
	d. OVER 1000 COUNT MIN



AC Cord

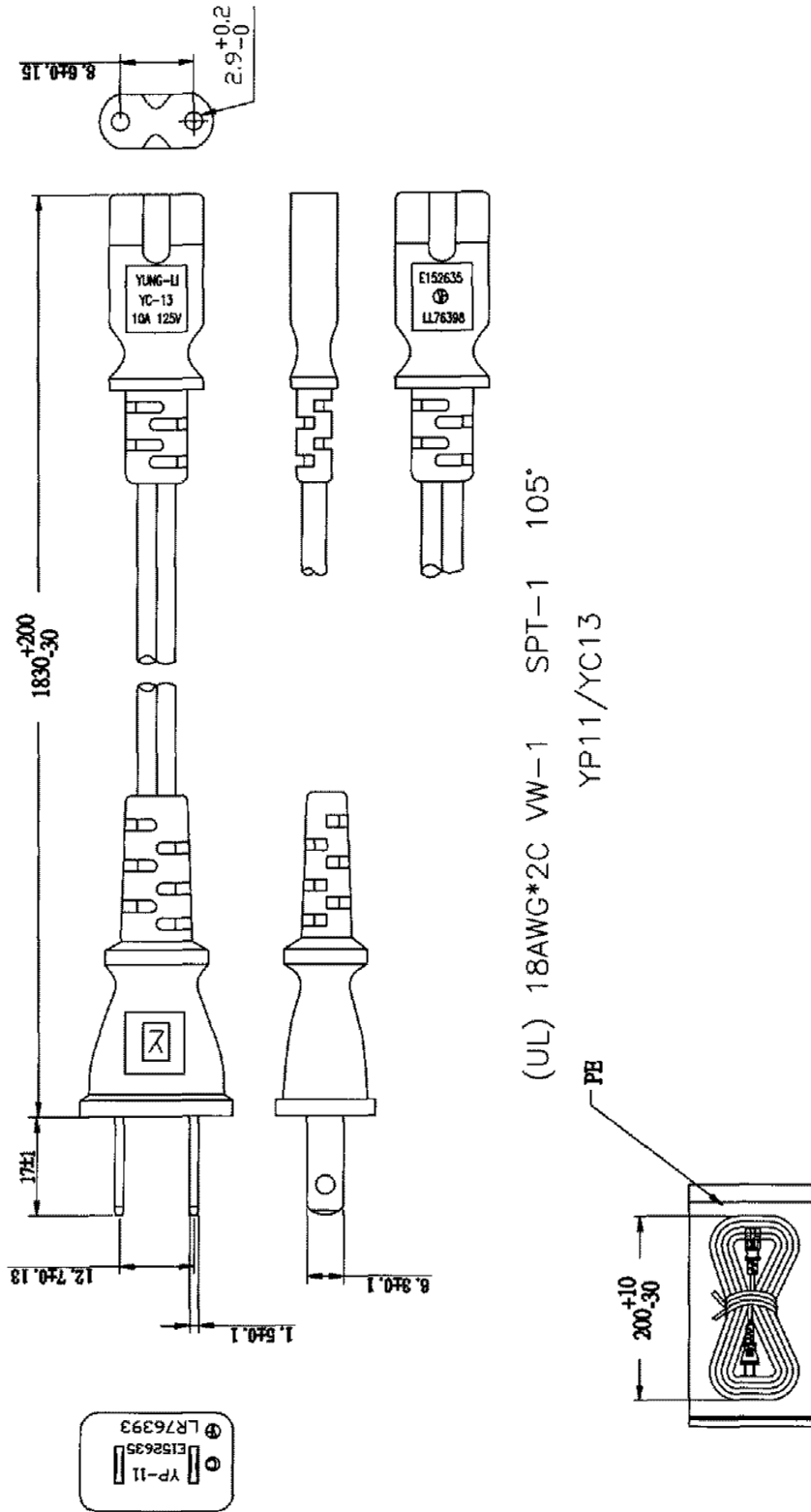



CUI INC

Part No: DTS090133SUDC-P5P-SZ

Date: 4/06/2006

Unit: mm

Description: switching power supply

Page No: 6 of 7

Individual Packaging

Tolerance: ± 1



AC CORD

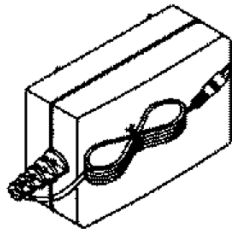

product

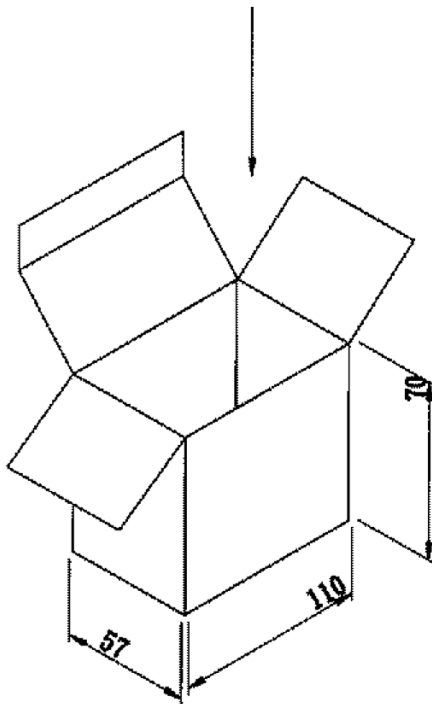

"RoHS Compliant"



Packaging

Tolerance: +7/-0

CARTON SIZE: 450*295*220mm

Q'TY: 60PCS(20*3)

"RoHS Compliant"

