

SCHOTTKY RECTIFIER

80Amp

Major Ratings and Characteristics



Characteristics	88CNQ060	Units
$I_{F(AV)}$ Rectangular waveform	80	A
V_{RRM}	60	V
I_{FSM} @ $t_p = 5\mu s$ sine	7000	A
V_f @ 40Apk, $T_J = 125^\circ C$ (per leg)	0.56	V
T_J	-55 to 175	$^\circ C$

Description/Features

The 88CNQ060 center tap Schottky rectifier module has been optimized for very low forward voltage drop, with moderate leakage. The proprietary barrier technology allows for reliable operation up to $175^\circ C$ junction temperature. Typical applications are in switching power supplies, converters, free-wheeling diodes, and reverse battery protection.

- $175^\circ C$ T_J operation
- Center tap module
- High purity, high temperature epoxy encapsulation for enhanced mechanical strength and moisture resistance
- Low forward voltage drop
- High frequency operation
- Guard ring for enhanced ruggedness and long term reliability
- Low profile, small footprint, high current package

Case Styles

88CNQ060	88CNQ060SM	88CNQ060SL
 <p>D61 - 8</p>	 <p>SMD61-8</p>	 <p>SLD61-8</p>

88CNQ060



Voltage Ratings

Part number	88CNQ060
V_R Max. DC Reverse Voltage (V)	60
V_{RWM} Max. Working Peak Reverse Voltage (V)	

Absolute Maximum Ratings

Parameters	88CNQ	Units	Conditions
$I_{F(AV)}$ Max. Average Forward Current See Fig. 5	80	A	50% duty cycle @ $T_C = 95^\circ\text{C}$, rectangular waveform
I_{FSM} Max. Peak One Cycle Non - Repetitive Surge Current (Per Leg) See Fig. 7	7300	A	5 μs Sine or 3 μs Rect. pulse 10ms Sine Or 5ms Rect. pulse
	800		
E_{AS} Non - Repetitive Avalanche Energy (Per Leg)	75	mJ	$T_J = 25^\circ\text{C}$, $I_{AS} = 1.0\text{A}$, $L = 0.57\text{mH}$
I_{AR} Repetitive Avalanche Current (Per Leg)	1.0	A	Current decaying linearly to zero in 1 μsec Frequency limited by T_J max. $V_A = 1.5 \times V_R$ typical

Electrical Specifications

Parameters	88CNQ	Units	Conditions
V_{FM} Max. Forward Voltage Drop (Per Leg) See Fig. 1 \ominus	0.58	V	@ 40A $T_J = 25^\circ\text{C}$
	0.77	V	@ 83A
	0.56	V	@ 40A $T_J = 125^\circ\text{C}$
	0.67	V	@ 80A
	I_{RM} Max. Reverse Leakage Current (Per Leg) See Fig. 2 \ominus	0.64	mA
	240	mA	$T_J = 125^\circ\text{C}$
C_T Max. Junction Capacitance (Per Leg)	5200	pF	$V_R = 5\text{Voc}$, (test signal range 100kHz to 1MHz) 25°C
L_S Typical Series Inductance (Per Leg)	5.5	nH	Measured lead to lead 5mm from package body
dV/dt Max. Voltage Rate of Change (Rated V_R)	10,000	V/ μs	

Thermal-Mechanical Specifications

Parameters	88CNQ	Units	Conditions
T_J Max. Junction Temperature Range	-55 to 175	$^\circ\text{C}$	
T_{SG} Max. Storage Temperature Range	-55 to 175	$^\circ\text{C}$	
$R_{\theta JC}$ Max. Thermal Resistance, Junction to Case (Per Leg)	0.85	$^\circ\text{C/W}$	DC operation See Fig. 4
$R_{\theta VC}$ Max. Thermal Resistance, Junction to Case (Per Package)	0.42	$^\circ\text{C/W}$	DC operation
$R_{\theta CS}$ Typical Thermal Resistance, Case to Heat-sink (D61 - 8 Only)	0.30	$^\circ\text{C/W}$	Mounting surface, smooth and greased
w_t Approximate Weight	7.8 (0.28)	g (oz.)	
T Mounting Torque	Min. 40 (35)	Kg-cm (lb-in)	
	Max. 58 (50)		

\ominus Pulse Width < 300 μs , Duty Cycle < 2%

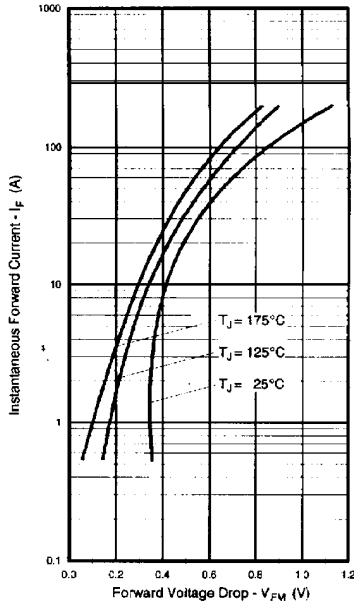

Fig. 1 - Max. Forward Voltage Drop Characteristics (Per Leg)

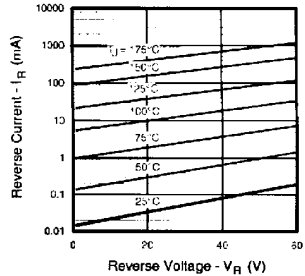

Fig. 2 - Typical Values of Reverse Current Vs. Reverse Voltage (Per Leg)

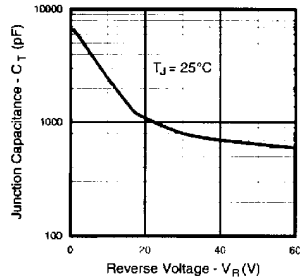
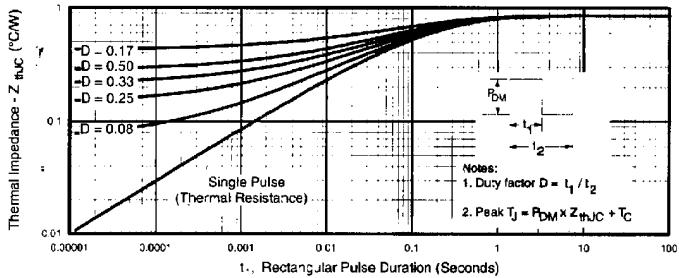

Fig. 3 - Typical Junction Capacitance Vs. Reverse Voltage (Per Leg)

 Fig. 4 - Max. Thermal Impedance Z_{thJC} Characteristics (Per Leg)

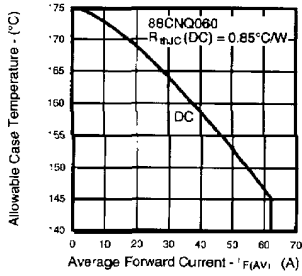

Fig. 5 - Max. Allowable Case Temperature Vs. Average Forward Current (Per Leg)

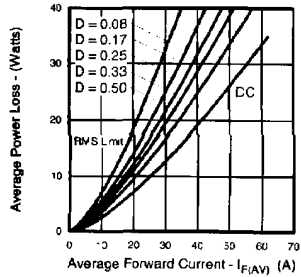

Fig. 6 - Forward Power Loss Characteristics (Per Leg)

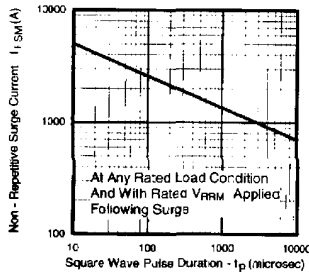

Fig.7 - Max. Non-Repetitive Surge Current (Per Leg)

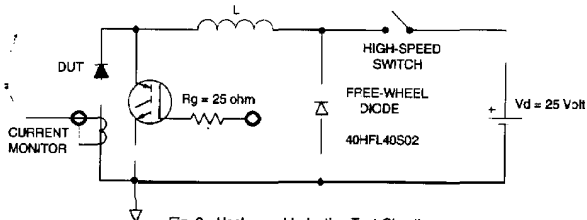
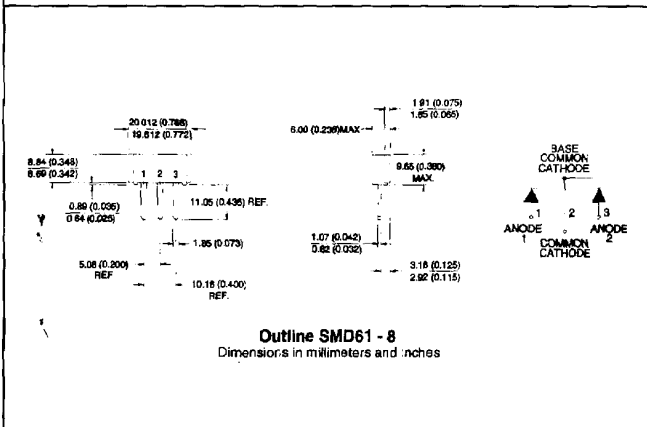
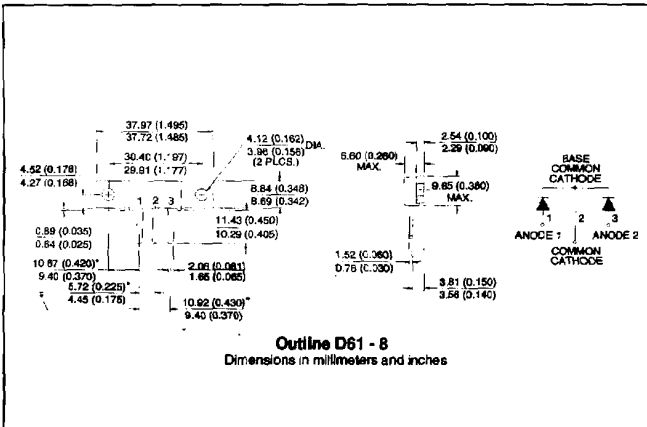
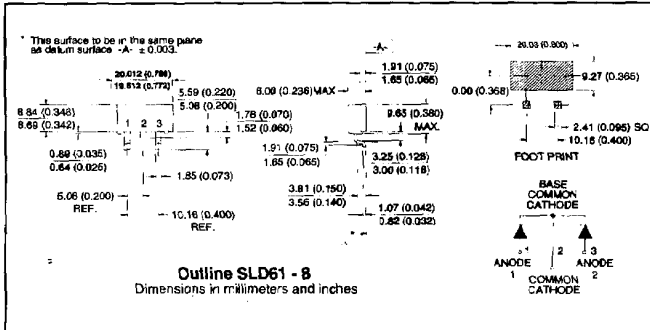

Fig. 8 - Unclamped Inductive Test Circuit





International
IR Rectifier

WORLD HEADQUARTERS: 233 Kansas St., El Segundo, California 90245, Tel: (310) 322-3331

EUROPEAN HEADQUARTERS: Hurst Green, Oxsted, Surrey RH8 9BB, UK Tel: (44) 0883 713215

IR CANADA: 7321 Victoria Park Ave., Suite 201, Markham, Ontario L3R 3L1, Tel: (905) 475 1897

IR GERMANY: Saalburgstrasse 157, 81350 Bad Homburg Tel: 6172 37066

IR ITALY: Via Llguna 49, 10071 Borgaro, Torino Tel: (39) 1145 10111

IR FAR EAST: K&H Bldg., 2F, 3-30-4 Nishi-Ikeburo 3-Chome, Toshima-Ki, Tokyo 171 Tel: (03)3983 0841

IR SOUTHEAST ASIA: 315 Outram Road, #10-02 Tan Boon Liat Building, Singapore 0316 Tel: 65 221 8371

Data and specifications subject to change without notice. 9/95