

IGBT SIP MODULE

Short Circuit Rated UltraFast IGBT

Features

- Short Circuit Rated - 10 μ s @ 125°C, $V_{GE} = 15V$
- Fully isolated printed circuit board mount package
- Switching-loss rating includes all "tail" losses
- HEXFRED™ soft ultrafast diodes
- Optimized for high operating frequency (over 5kHz)
See Fig. 1 for Current vs. Frequency curve

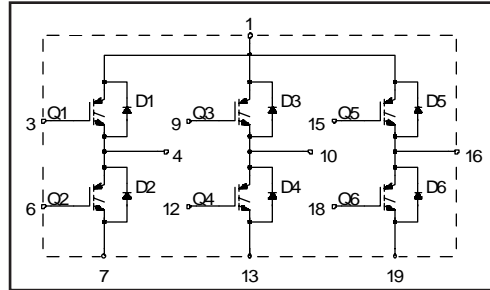

Product Summary

Output Current in a Typical 20 kHz Motor Drive

5.4 A_{RMS} per phase (1.7 kW total) with $T_C = 90^\circ C$, $T_J = 125^\circ C$, Supply Voltage 360Vdc, Power Factor 0.8, Modulation Depth 80% (See Figure 1)

Description

The IGBT technology is the key to International Rectifier's advanced line of IMS (Insulated Metal Substrate) Power Modules. These modules are more efficient than comparable bipolar transistor modules, while at the same time having the simpler gate-drive requirements of the familiar power MOSFET. This superior technology has now been coupled to a state of the art materials system that maximizes power throughput with low thermal resistance. This package is highly suited to power applications and where space is at a premium.

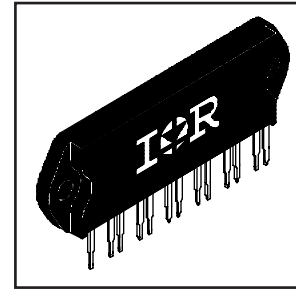

These new short circuit rated devices are especially suited for motor control and other totem-pole applications requiring short circuit withstand capability.

Absolute Maximum Ratings

	Parameter	Max.	Units
V_{CES}	Collector-to-Emitter Voltage	600	V
$I_C @ T_C = 25^\circ C$	Continuous Collector Current, each IGBT	11	A
$I_C @ T_C = 100^\circ C$	Continuous Collector Current, each IGBT	6.0	
I_{CM}	Pulsed Collector Current ①	22	
I_{LM}	Clamped Inductive Load Current ②	22	
$I_F @ T_C = 100^\circ C$	Diode Continuous Forward Current	6.1	
I_{FM}	Diode Maximum Forward Current	22	
t_{sc}	Short Circuit Withstand Time	10	μ s
V_{GE}	Gate-to-Emitter Voltage	± 20	V
V_{ISOL}	Isolation Voltage, any terminal to case, 1 minute	2500	V_{RMS}
$P_D @ T_C = 25^\circ C$	Maximum Power Dissipation, each IGBT	36	W
$P_D @ T_C = 100^\circ C$	Maximum Power Dissipation, each IGBT	14	
T_J T_{STG}	Operating Junction and Storage Temperature Range	-40 to +150	°C
	Soldering Temperature, for 10 sec.	300 (0.063 in. (1.6mm) from case)	
	Mounting torque, 6-32 or M3 screw.	5-7 lbf•in (0.55 - 0.8 N•m)	

Thermal Resistance

	Parameter	Typ.	Max.	Units
$R_{\theta JC}(IGBT)$	Junction-to-Case, each IGBT, one IGBT in conduction	-----	3.5	°C/W
$R_{\theta JC}(DIODE)$	Junction-to-Case, each diode, one diode in conduction	-----	5.5	
$R_{\theta CS}(MODULE)$	Case-to-Sink, flat, greased surface	0.1	-----	
Wt	Weight of module	20 (0.7)	-----	g (oz)

CPV363MK



Electrical Characteristics @ $T_J = 25^\circ\text{C}$ (unless otherwise specified)

	Parameter	Min.	Typ.	Max.	Units	Conditions
$V_{(BR)CES}$	Collector-to-Emitter Breakdown Voltage ^③	600	----	----	V	$V_{GE} = 0V, I_C = 250\mu A$
$\Delta V_{(BR)CES}/\Delta T_J$	Temperature Coeff. of Breakdown Voltage	----	0.45	----	V/ $^\circ\text{C}$	$V_{GE} = 0V, I_C = 1.0mA$
$V_{CE(on)}$	Collector-to-Emitter Saturation Voltage	----	2.0	3.0	V	$I_C = 6.0A, V_{GE} = 15V$ See Fig. 2, 5
		----	2.5	----		
		----	2.1	----		
$V_{GE(th)}$	Gate Threshold Voltage	3.0	----	5.5		$V_{CE} = V_{GE}, I_C = 250\mu A$
$\Delta V_{GE(th)}/\Delta T_J$	Temperature Coeff. of Threshold Voltage	----	-13	----	mV/ $^\circ\text{C}$	$V_{CE} = V_{GE}, I_C = 250\mu A$
g_{fe}	Forward Transconductance ^④	3.0	6.0	----	S	$V_{CE} = 100V, I_C = 12A$
I_{CES}	Zero Gate Voltage Collector Current	----	----	250	μA	$V_{GE} = 0V, V_{CE} = 600V$
		----	----	2500		$V_{GE} = 0V, V_{CE} = 600V, T_J = 150^\circ\text{C}$
V_{FM}	Diode Forward Voltage Drop	----	1.4	1.7	V	$I_C = 12A$ See Fig. 13
		----	1.3	1.6		$I_C = 12A, T_J = 150^\circ\text{C}$
I_{GES}	Gate-to-Emitter Leakage Current	----	----	± 500	nA	$V_{GE} = \pm 20V$

Switching Characteristics @ $T_J = 25^\circ\text{C}$ (unless otherwise specified)

	Parameter	Min.	Typ.	Max.	Units	Conditions
Q_g	Total Gate Charge (turn-on)	----	34	52	nC	$I_C = 12A$ $V_{CC} = 400V$ See Fig. 8
Q_{ge}	Gate - Emitter Charge (turn-on)	----	7.8	12		
Q_{gc}	Gate - Collector Charge (turn-on)	----	13	21		
$t_{d(on)}$	Turn-On Delay Time	----	64	----	ns	$T_J = 25^\circ\text{C}$ $I_C = 6.0A, V_{CC} = 480V$ $V_{GE} = 15V, R_G = 23\Omega$ Energy losses include "tail" and diode reverse recovery.
t_r	Rise Time	----	24	----		
$t_{d(off)}$	Turn-Off Delay Time	----	130	200	mJ	See Fig. 9, 10, 11, 18
t_f	Fall Time	----	20	30		
E_{on}	Turn-On Switching Loss	----	0.23	----	μs	$V_{CC} = 360V, T_J = 125^\circ\text{C}$ $V_{GE} = 15V, R_G = 23\Omega, V_{CPK} < 500V$
E_{off}	Turn-Off Switching Loss	----	0.17	----		
E_{ts}	Total Switching Loss	----	0.40	0.60		
t_{sc}	Short Circuit Withstand Time	10	----	----	ns	$T_J = 150^\circ\text{C}$, See Fig. 9, 10, 11, 18 $I_C = 6.0A, V_{CC} = 480V$ $V_{GE} = 15V, R_G = 23\Omega$ Energy losses include "tail" and diode reverse recovery.
$t_{d(on)}$	Turn-On Delay Time	----	58	----		
t_r	Rise Time	----	24	----	mJ	See Fig. 7
$t_{d(off)}$	Turn-Off Delay Time	----	240	----		
t_f	Fall Time	----	140	----	pF	$V_{GE} = 0V$ $V_{CC} = 30V$ $f = 1.0MHz$
E_{ts}	Total Switching Loss	----	0.61	----		
C_{ies}	Input Capacitance	----	740	----	ns	$T_J = 25^\circ\text{C}$ See Fig. 14 $T_J = 125^\circ\text{C}$
C_{oes}	Output Capacitance	----	100	----		
C_{res}	Reverse Transfer Capacitance	----	9.3	----	A	$T_J = 25^\circ\text{C}$ See Fig. 15 $T_J = 125^\circ\text{C}$
t_{rr}	Diode Reverse Recovery Time	----	42	60		
I_{rr}	Diode Peak Reverse Recovery Current	----	3.5	6.0	nC	$T_J = 25^\circ\text{C}$ See Fig. 16 $T_J = 125^\circ\text{C}$
		----	5.6	10		
Q_{rr}	Diode Reverse Recovery Charge	----	80	180	ns	$T_J = 25^\circ\text{C}$ See Fig. 16 $T_J = 125^\circ\text{C}$
		----	220	600		
μs	A/ μs	$d_{(rec)M}/dt$	Diode Peak Rate of Fall of Recovery	----	180	During t_b
----				$T_J = 25^\circ\text{C}$ See Fig. 17		

Notes:

① Repetitive rating; $V_{GE}=20V$, pulse width limited by max. junction temperature. (See fig. 20)

② $V_{CC}=80\%(V_{CES}), V_{GE}=20V, L=10\mu H, R_G=23\Omega,$ (See fig. 19)

③ Pulse width $\leq 80\mu s$; duty factor $\leq 0.1\%$.

④ Pulse width 5.0 μs , single shot.

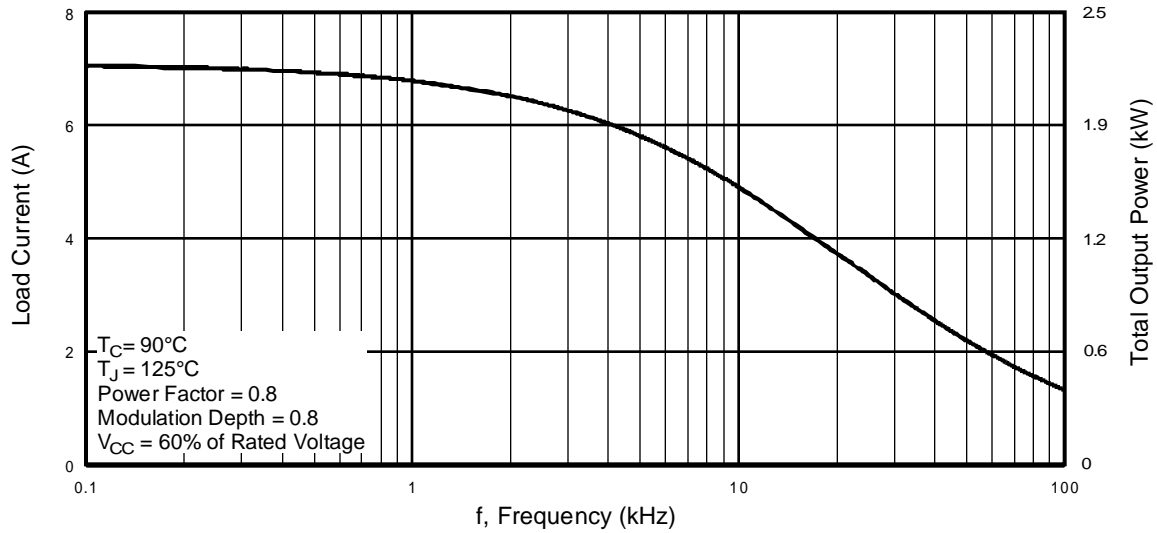

Fig. 1 - RMS Current and Output Power, Synthesized Sine Wave

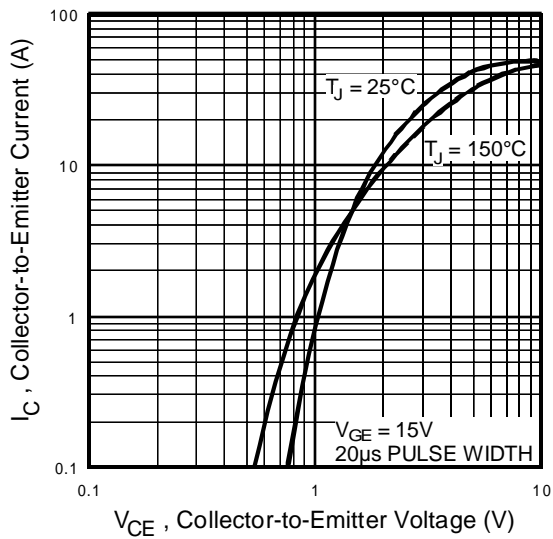

Fig. 2 - Typical Output Characteristics

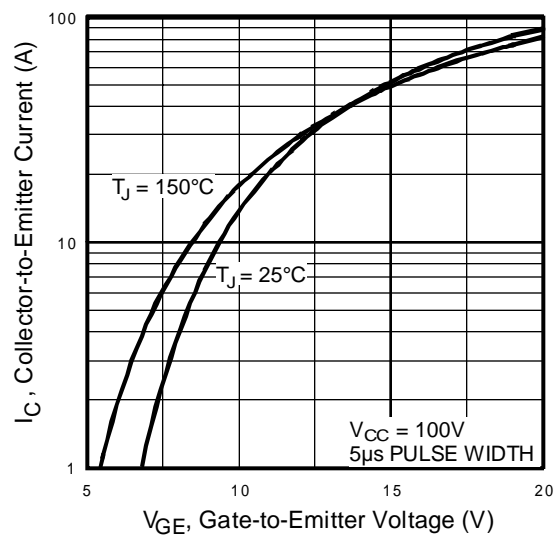

Fig. 3 - Typical Transfer Characteristics

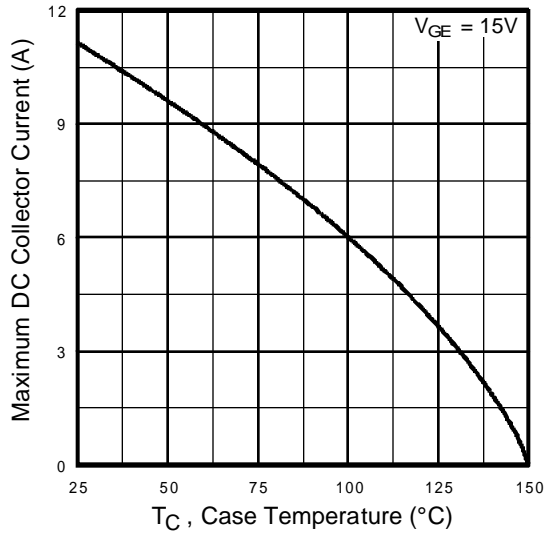

Fig. 4 - Maximum Collector Current vs. Case Temperature

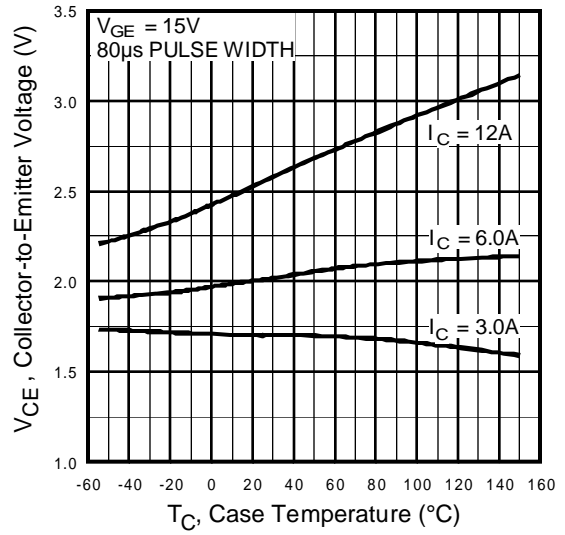

Fig. 5 - Collector-to-Emitter Voltage vs. Case Temperature

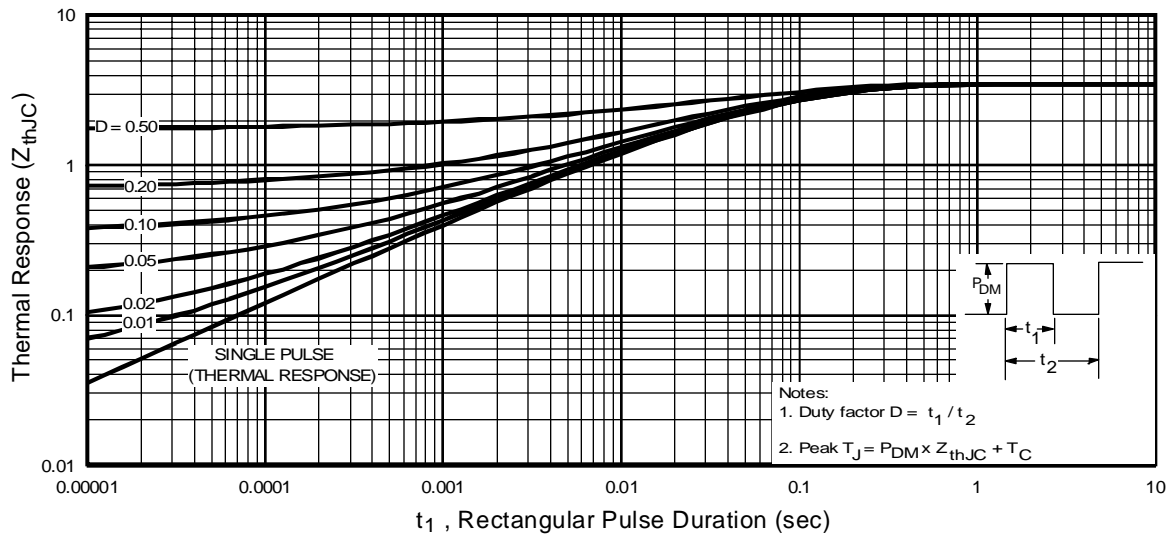

Fig. 6 - Maximum IGBT Effective Transient Thermal Impedance, Junction-to-Case

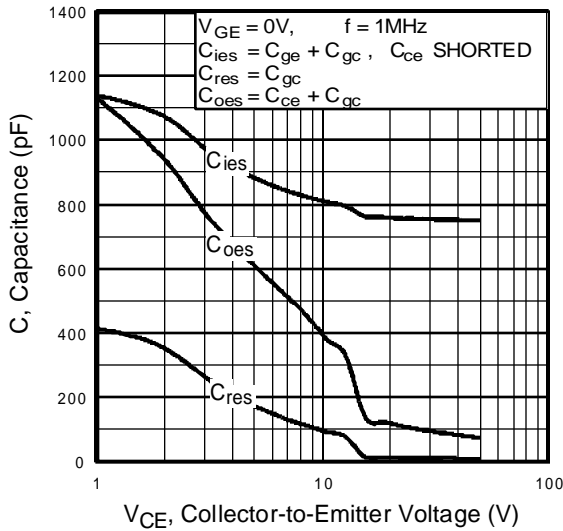

Fig. 7 - Typical Capacitance vs. Collector-to-Emitter Voltage

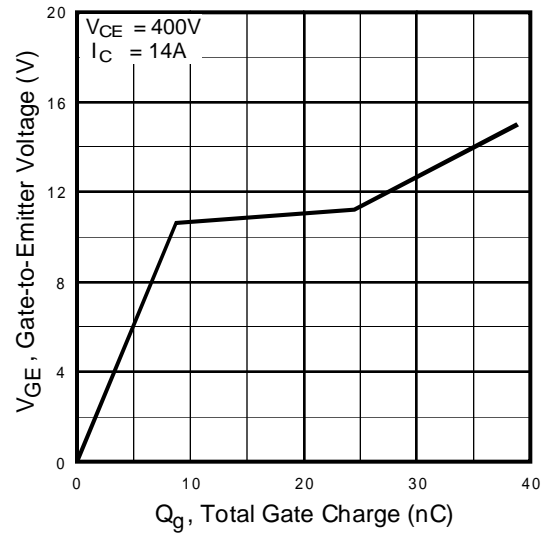

Fig. 8 - Typical Gate Charge vs. Gate-to-Emitter Voltage

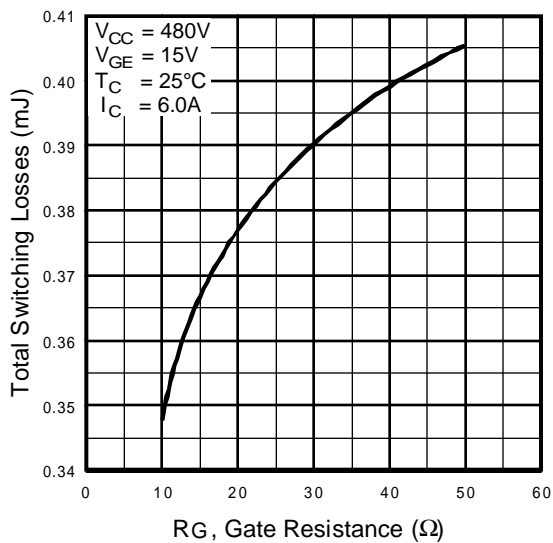

Fig. 9 - Typical Switching Losses vs. Gate Resistance

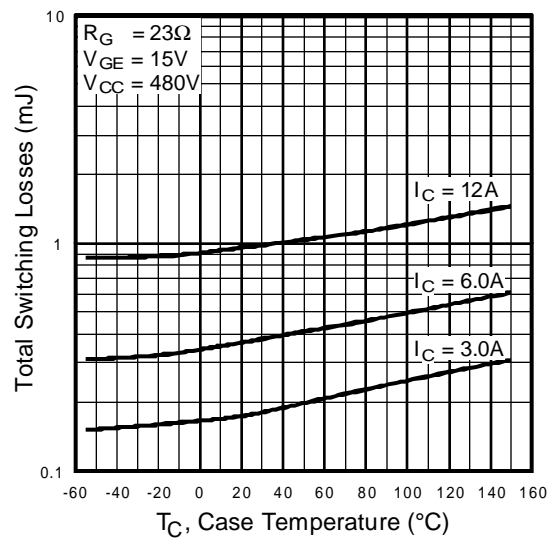

Fig. 10 - Typical Switching Losses vs. Case Temperature

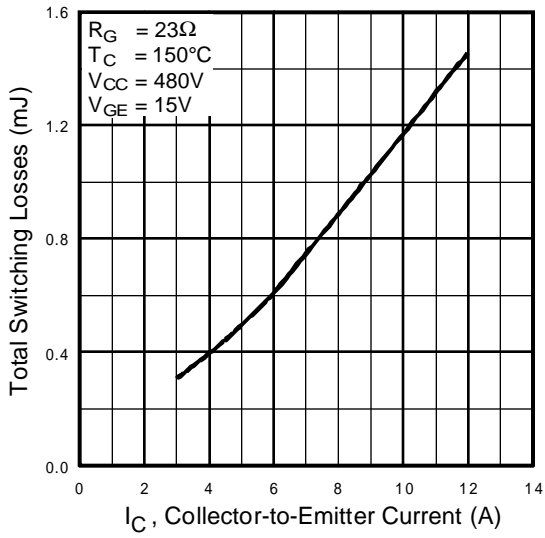

Fig. 11 - Typical Switching Losses vs. Collector-to-Emitter Current

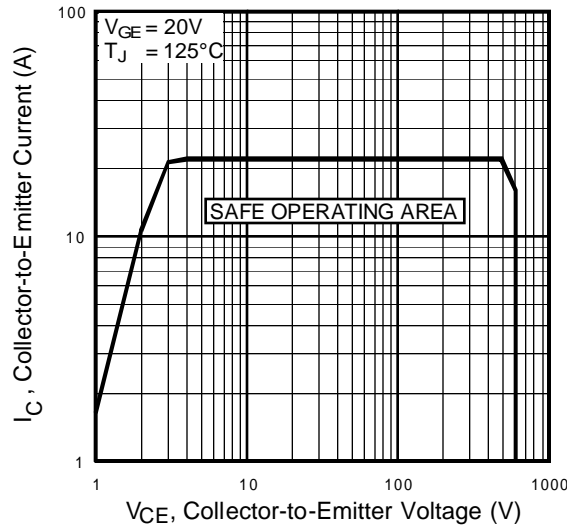

Fig. 12 - Turn-Off SOA

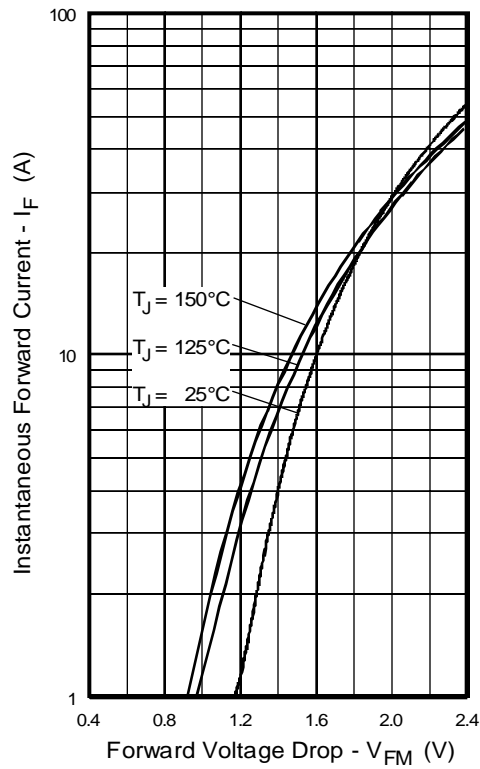

Fig. 13 - Maximum Forward Voltage Drop vs. Instantaneous Forward Current

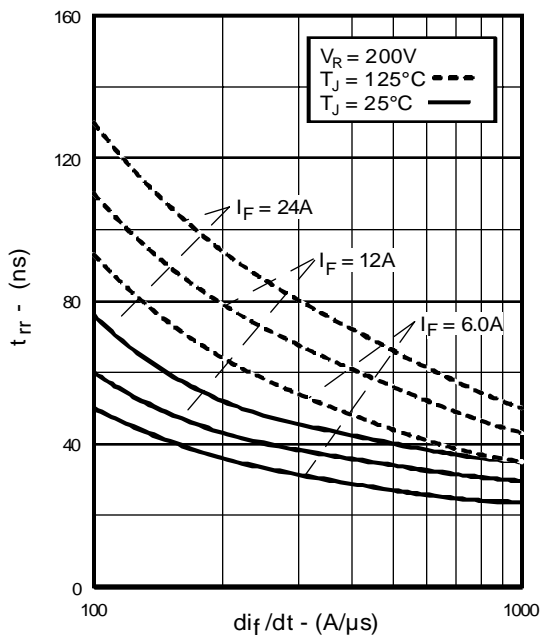

Fig. 14 - Typical Reverse Recovery vs. di_f/dt

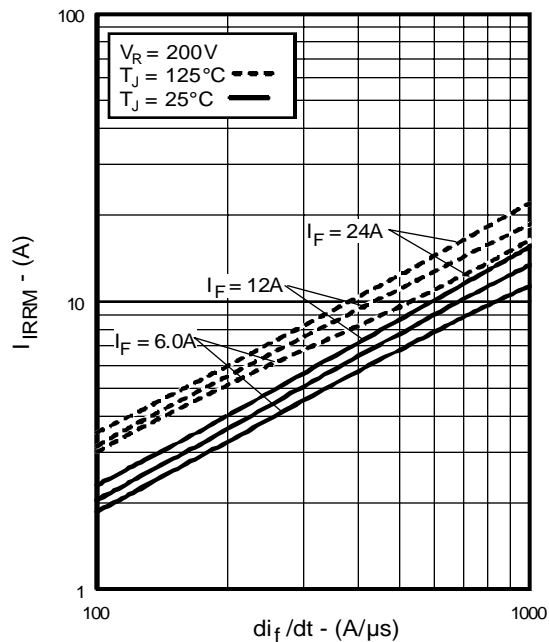

Fig. 15 - Typical Recovery Current vs. di_f/dt

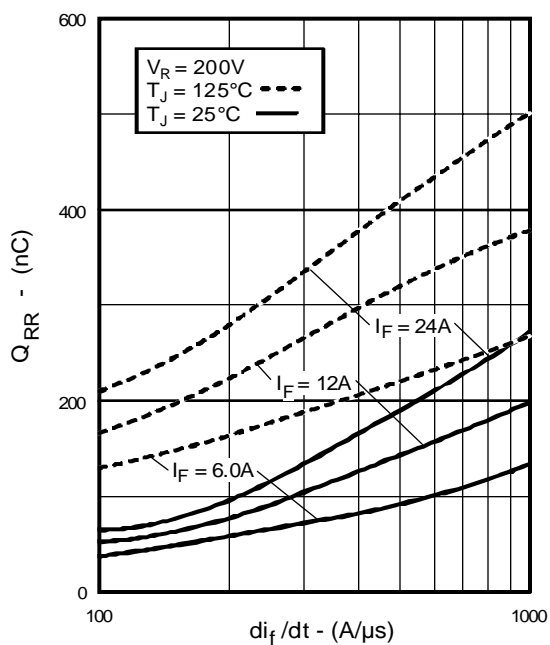

Fig. 16 - Typical Stored Charge vs. di_f/dt

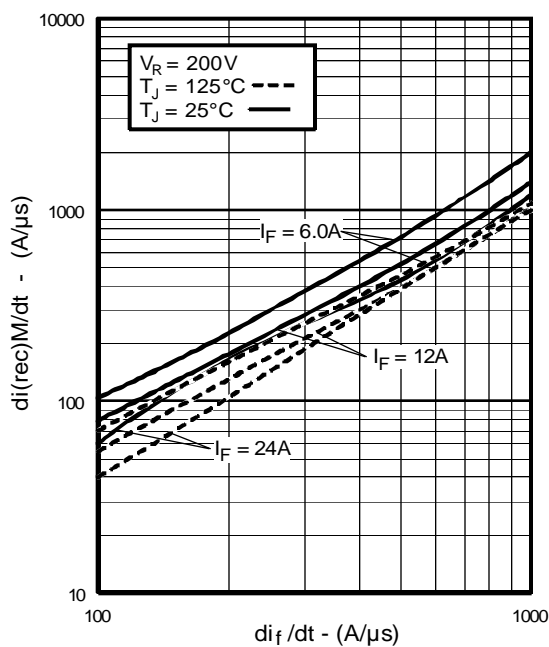

Fig. 17 - Typical $di_{(rec)M}/dt$ vs. di_f/dt

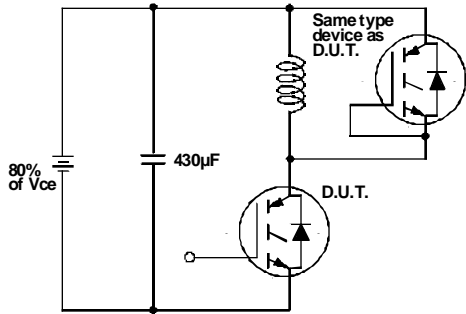

Fig. 18a - Test Circuit for Measurement of I_{LM} , E_{on} , $E_{off}(\text{diode})$, t_{rr} , Q_{rr} , I_{rr} , $t_{d(on)}$, t_r , $t_{d(off)}$, t_f

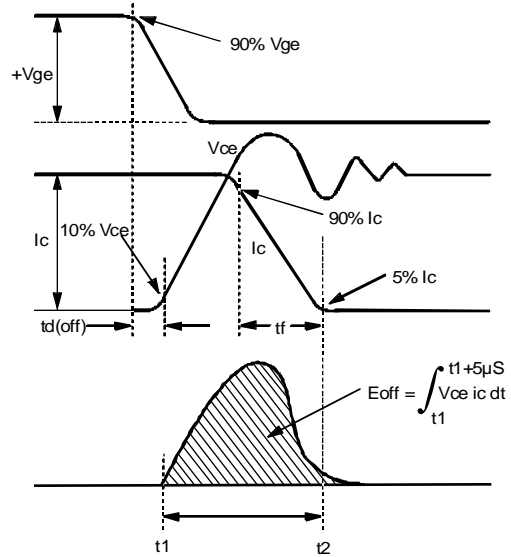

Fig. 18b - Test Waveforms for Circuit of Fig. 18a, Defining E_{off} , $t_{d(off)}$, t_f

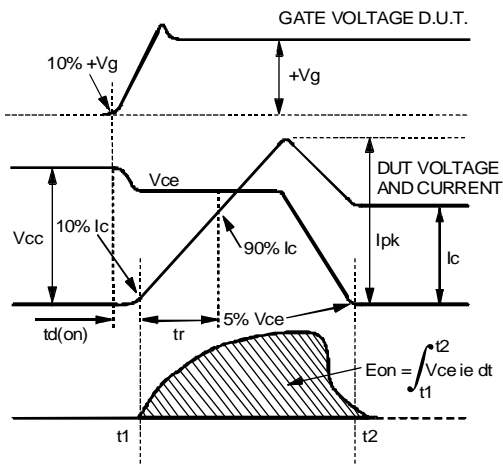

Fig. 18c - Test Waveforms for Circuit of Fig. 18a, Defining E_{on} , $t_{d(on)}$, t_r

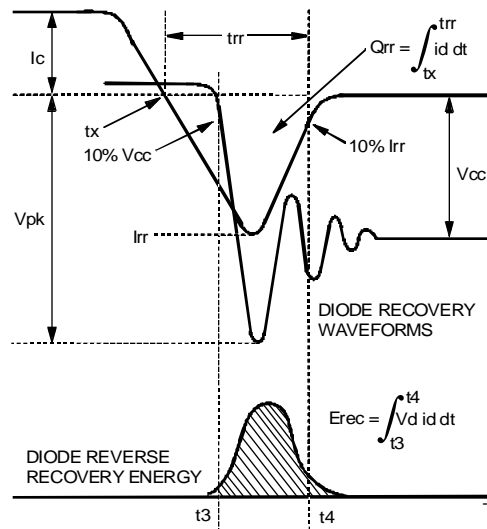

Fig. 18d - Test Waveforms for Circuit of Fig. 18a, Defining E_{rec} , t_{rr} , Q_{rr} , I_{rr}



CPV363MK

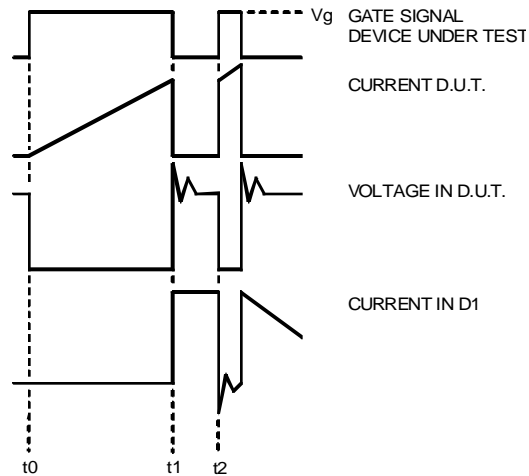

Fig. 18e - Macro Waveforms for Test Circuit of Fig. 18a

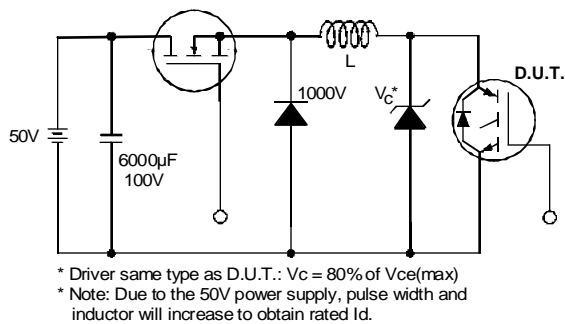

Fig. 19 - Clamped Inductive Load Test Circuit

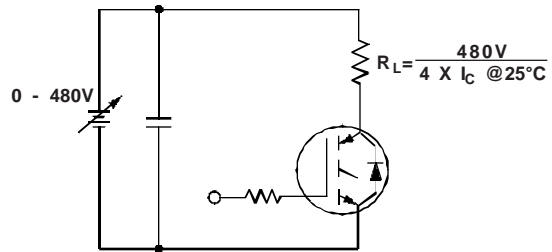
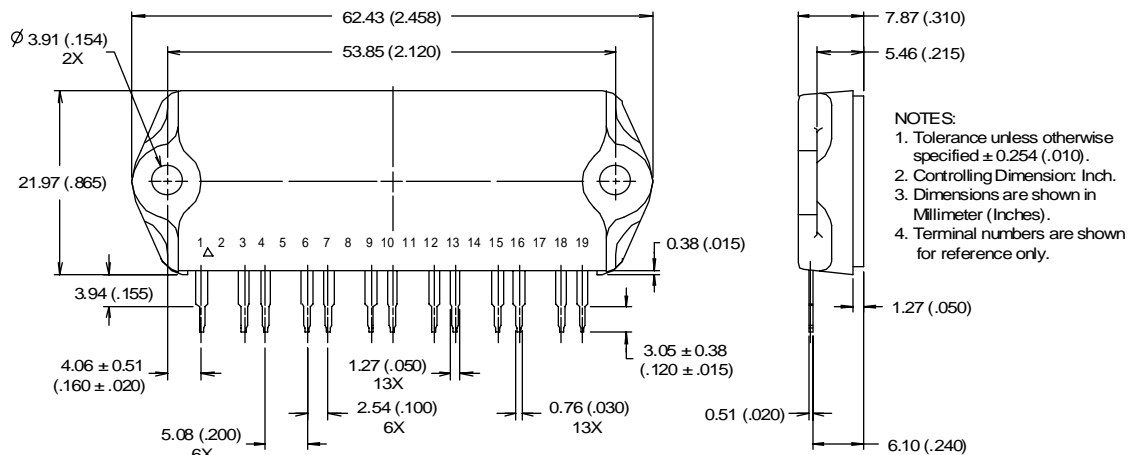

Fig. 20 - Pulsed Collector Current Test Circuit



IMS-2 Package Outline (13 Pins)
 Dimensions in Millimeters and (Inches)